



Operation manual

ES1-S PRO
ES1-X PRO

Owner's Manual

Catalog

1 Means of representation	9
1.1 Symbols used.....	9
1.2 Formats used.....	9
2 Safety advice	9
2.1 Use definition - intended use.....	9
2.2 Safety advice.....	9
2.3 Degrees of risk and symbols.....	10
2.4 Safe operation.....	10
2.5 Protective clothing.....	11
2.6 Work rules.....	11
2.7 Environment.....	11
2.8 User' s manual.....	11
3 Important notes	13
3.1 Manufacturer and implied warranty.....	13
3.2 Operating and auxiliary substances.....	13
3.3 Spare parts, accessories.....	13
3.4 Service.....	13
3.5 Figures.....	14
3.6 Customer service.....	14

4 View of motorcycle	15
4.1 View of motorcycle, front left (example).....	15
4.2 View of motorcycle, top (example).....	16
5 Serial numbers	17
5.1 Chassis Number.....	17
5.2 Nameplate.....	17
5.3 Motor number.....	17
6 Controls	18
6.1 Front brake lever.....	18
6.2 Rear brake lever.....	18
6.3 Throttle grip.....	18
6.4 Key-Switch/Steering Lock.....	18
6.5 Remote controller.....	19
6.6 Start/Stop button	19
6.7 Headlight Switch.....	20
6.8 Driving mode Switch.....	20
6.9 Emergency flasher switch.....	20
6.10 Headlight High/Low Beam Switch.....	21
6.11 Steering lamp switch.....	21
6.12 Horn Button.....	21
6.13 Seat/helmet lock.....	22

6.14	Charging dock.....	22
6.15	Side stand.....	23
7	Speedometer.....	23
7.1	Adjustment button.....	23
7.2	Speed display.....	23
7.3	Driving mode display.....	24
7.4	Current display.....	24
7.5	Odometer	24
7.6	Temperature display.....	24
7.7	Battery display.....	25
7.8	Charging indicator.....	25
7.9	Steering indicator.....	25
7.10	READY indicator.....	26
7.11	High beam indicator.....	26
7.12	Parking indicator.....	26
7.13	Error code indicator.....	26
7.14	Time setting.....	27
7.15	Set the diameter of rear tire.....	27
7.16	Set the MM/INCH.....	28
7.17	Service indicator.....	28
8	How to drive this motorcycle.....	29

8.1	Checks and service when preparing for use.....	30
8.2	Starting.....	30
8.3	Starting off.....	31
8.4	Braking.....	31
8.5	Stopping, parking.....	32
8.6	Shutting down the motorcycle.....	33
8.7	Transporting the motorcycle.....	34
8.8	Transporting the battery.....	33
9	Service schedule.....	35
9.1	Required work.....	35
9.2	Recommended inspection.....	36
10	Motorcycle adjustment operation.....	37
10.1	Adjustment of rebound damping of front shock absorber.....	37
10.2	Adjusting the spring preload of the rear shock absorber.....	38
10.3	Checking the chain tension.....	37
10.4	Adjusting the chain tension.....	39
10.5	Checking chain dirt accumulation.....	40
10.6	Clean the chain.....	41
11	Braking system.....	41
11.1	Checking the brake disc.....	41

11.2	Check the brake lining.....	42
11.3	Checking the brake fluid.....	42
12	Wheels, tires.....	43
12.1	Checking the status of wheels and tires	44
12.2	Checking the tire pressure.....	44
13	Battery.....	45
13.1	Install the battery.....	45
13.2	Removing the battery.....	45
13.3	Battery charging.....	45
14	Service for the Motor.....	48
14.1	Checking the gear oil.....	48
14.2	Changing the gear oil.....	48
15	Cleaning and service	49
15.1	Cleaning the motorcycle.....	49
15.2	Inspection and service for use during.....	49
16	Storage	52
16.1	Storage.....	52
16.2	Preparing for use after storage.....	52
17	Troubleshooting.....	54
18	Technical Data.....	56

18.1	Motor.....	57
18.2	Complete motorcycle.....	57
18.3	Electrical System.....	58

DEAR KOLLTER CUSTOMER

Congratulations on your decision to purchase a KOLLTER motorcycle. You are now the owner of a state-of-the-art sports motorcycle that will give you enormous pleasure if you service and maintain it properly.

Enter the serial numbers of your motorcycle below.

Chassis Number	Dealer's stamp
Engine Number	

The Owner's Manual contained the latest information for this model series at the time of going to print. Slight deviations caused by continuing development and design of the motorcycles can, however, not be completely excluded.

All specifications are non-binding. KOLLTER specifically reserves the right to modify or delete technical specifications, prices, colors, forms, materials, services, designs, equipment, etc., without prior notice and without specifying reasons, to adapt these to local conditions, as well as to stop production of a particular model without prior notice. KOLLTER accepts no liability for delivery options, deviations from illustrations and descriptions, misprints, and other errors. The models portrayed partly contain special equipment that does not belong to the regular scope of supply.

If you have any questions about this motorcycle, please contact our customer service center.

Wish you a safe and happy riding experience!

1 Means of representation

1.1 Symbols used

The meaning of specific symbols is described below.



All work marked with this symbol requires specialist knowledge and technical understanding. In the interest of your own safety, have these jobs performed by an authorized KOLLTER workshop. There, your motorcycle will be optimally serviced for by specially trained experts using the specialist tools required.



Specify the referenced page (the given page contains more information about it).



Indicates information with more details or tips.

1.2 Formats used

The typographical formats used in this document are explained below.

Specific name	Identifies a proprietary name.
<u>Underlined terms</u>	Refer to technical details of the motorcycle or indicate technical terms that are explained in the glossary.

2 Safety advice

2.1 Use definition - intended use

KOLLTER sport motorcycles are designed and made to withstand the normal stresses use.



Info

Only trained personnel are allowed to use vehicles.

2.2 Safety advice

A number of safety instructions need to be followed to operate the motorcycle safely. Therefore, read this manual carefully. The safety instructions are highlighted in the text and are referred to at the relevant passages.



Info

The motorcycle has various information and warning labels at prominent locations. Do not remove information/warning labels. If they are missing, you or others may not recognize dangers and may therefore be injured.

2.3 Degrees of risk and symbols



Danger

Indicates a danger that will immediately and invariably lead to fatal or serious permanent injury if the appropriate measures are not taken.



Warning

Indicates a danger that is likely to lead to fatal or serious injury if the appropriate measures are not taken.



Caution

Indicates a danger that may lead to minor injuries if the appropriate measures are not taken.



Note

Indicates a danger that will lead to considerable machine and material damage if the appropriate measures are not taken.



Warning

Indicates a danger that will lead to environmental damage if the appropriate measures are not taken.

2.4 Safe operation

Only operate the motorcycle when it is in perfect technical condition, in accordance with its intended use, and in a safe and environmentally compatible manner.

An appropriate driver's license is needed to ride the motorcycle on public roads.

Have malfunctions that impair safety promptly eliminated by an authorized KOLLTER workshop.

Adhere to the information and warning labels on the motorcycle.



Danger

A rider who is not fit to ride poses a danger to him or herself and others.

Do not operate the motorcycle if you are not fit to ride due to alcohol, drugs or medication.



Warning

Some motorcycle components become very hot when the motorcycle is operated.

Do not touch any parts such as the motor, shock absorber, or braking system before the motorcycle parts have cooled down.

2.5 Protective clothing

In the interest of your own safety, KOLLTER recommends that you only operate the motorcycle while wearing protective clothing.



Warning

Missing or poor protective clothing presents an increased safety risk.

- Wear appropriate protective clothing such as helmet, boots, gloves as well as trousers and a jacket with protectors on all rides.
- Always wear protective clothing that is in good condition and meets the legal regulations.

2.6 Work rules

Special tools are necessary for certain tasks. The tools are not contained in the motorcycle but can be ordered under the number in parentheses.

During assembly, non-reusable parts (e.g. self-locking screws and nuts, seals and seal rings, O-rings, pins, lock washers) must be replaced by new parts.

In some instances, a thread locker (e.g. Loctite ®) is required. The manufacturer instructions for use must be followed.

After disassembly, clean the parts that are to be reused and check them for damage and wear. Change damaged or worn parts.

After you complete the repair or service work, check the operating safety of the motorcycle.

2.7 Environment

If you use your motorcycle responsibly, you can ensure that problems and conflicts do not occur. To protect the future of the motorcycle sport, make sure that you use your motorcycle legally, display environmental consciousness, and respect the rights of others.

When disposing of used oil, other operating and auxiliary fluids, and used components, comply with the laws and regulations of the respective country.

Your authorized KOLLTER dealer will be glad to advise you.

2.8 User's manual

It is important that you read this Owner's Manual carefully and completely before making your first trip. The Owner's Manual contains useful information and many tips on how to operate, handle, and maintain your motorcycle. Only then will you find out how to customize the motorcycle ideally for

your own use and how you can protect yourself from injury.

Keep the Owner's Manual in an accessible place to enable you to refer to it as needed.

If you would like to know more about the motorcycle or have questions on the material you read, please contact an authorized KOLLTER dealer.

The Owner's Manual is an important component of the motorcycle and should be handed over to the new owner if the motorcycle is sold.

3 Important notes

3.1 Manufacturer and implied warranty

The work specified in the service schedule may only be performed in an authorized KOLLTER workshop and must be recorded in both the Service & Warranty Booklet, otherwise any warranty coverage will become void. Damage or secondary damage caused by tampering with and/or conversions on the motorcycle is not covered by the warranty. Additional information on the manufacturer or implied warranty and the procedures involved can be found in the Service & Warranty Booklet.

3.2 Operating and auxiliary substances



Warning

Environmental hazard Improper handling of lubricating oil is a danger to the environment.

Do not allow lubricating oil to enter the groundwater, the soil, or the sewage system.

Use operating and auxiliary substances (such as lubricants) as specified in the Owner's Manual.

3.3 Spare parts, accessories

For your own safety, only use spare parts and accessory products that are approved and/or recommended by KOLLTER and have them installed by an authorized KOLLTER workshop. KOLLTER accepts no liability for other products and any resulting damage or loss.

Certain spare parts and accessory products are specified in parentheses in the descriptions. Your authorized KTM dealer will be glad to advise you.

The current KOLLTER Power-Parts for your motorcycle can be found on the KOLLTER website.

International KOLLTER Website: <http://www.KOLLTER.com>

3.4 Service

A prerequisite for perfect operation and prevention of premature wear is that the service, motorcycle, and tuning work on the engine and chassis is properly serviced out as described in the Owner's Manual. Incorrect adjustment and tuning of the engine and chassis can lead to damage and breakage of components.

Use of the motorcycle under difficult conditions, such as on sand or on wet and muddy surfaces, can lead to considerably more rapid wear of components such as the drive train, braking system, or suspension components. For this reason, it may be necessary to inspect or replace parts before the next scheduled service.

It is imperative that you adhere to the stipulated run-in times and service intervals. If you observe these exactly, you will ensure a much longer service life for your motorcycle.

3.5 Figures

The figures contained in the manual may depict special equipment.

In the interest of clarity, some components may be shown disassembled or may not be shown at all. It is not always necessary to disassemble the component to perform the activity in question. Please follow the instructions in the text.

3.6 Customer service

Authorized KOLLTER dealer will be happy to answer any questions you may have on motorcycle and KOLLTER.

The list of authorized KTM dealers can be found on the KOLLTER website.

International KOLLTER Website: <http://www.KOLLTER.com>

4 View of motorcycle

4.1 View of motorcycle, front left (example)

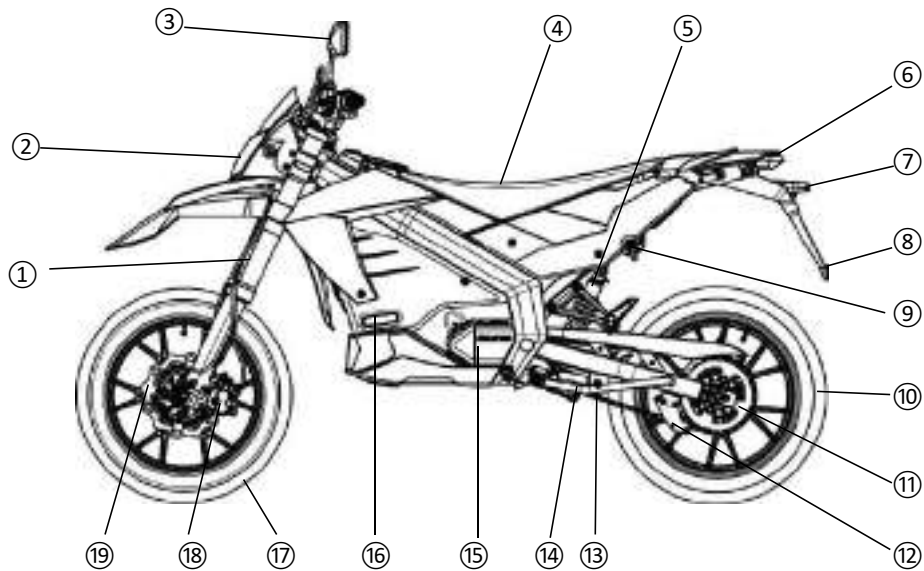

- ① Front shock absorber ② Front headlight ③ Rearview ④ Cushion ⑤ Rear shock absorber
⑥ Rear tail lamp ⑦ Rear license plate lamp ⑧ Rear reflector ⑨ Seat lock ⑩ Rear tire
⑪ Rear chain sprocket ⑫ Chain guide ⑬ Chain ⑭ Side stand ⑮ Motor ⑯ Side reflector
⑰ Front tire ⑱ Front disc brake pump ⑲ Front brake disc

4.2 View of motorcycle, top (example)

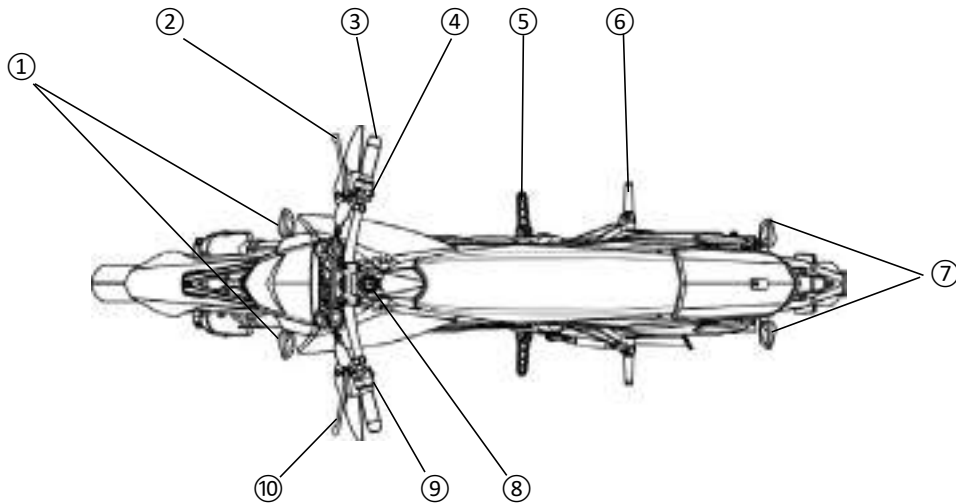

- ① Front switch light ② Front brake handle ③ Accelerating handle ④ Right handle switch
⑤ Front foot rest ⑥ Rear foot rest ⑦ Rear steering lamp ⑧ Start and stop button ⑨ Left hand
handle switch ⑩ Rear brake handle

5 Serial numbers

5.1 Chassis Number



The chassis number ❶ is stamped on the right side of the steering head.

5.2 Nameplate



The nameplate ❶ is mounted on the chassis at the front right.

5.3 Motor number



The engine number is stamped on the left side of the engine under the engine sprocket.

A barcode label with the motor number is attached to the right cover of the motor for easy viewing.

6 Controls

6.1 Front brake lever



The front brake handle ❶ is fitted on the right side of the handlebar.

6.2 Rear brake lever



The rear brake lever ❶ is fitted on the left side of the handlebar.

6.3 Throttle grip



The throttle grip ❶ is fitted on the right side of the handlebar.

6.4 Key-Switch/Steering Lock



The Key-Switch/Steering Lock is between the speedometer and handlebar.

○ In this position, the motorcycle is started.



⊗ In this position, the motorcycle cannot be activated.

🔒 in this position, the steering is locked.

i Info

- The steering lock is used to lock the steering. Steering and therefore riding is no longer possible.
- Using the steering lock when parked prevents unauthorized use and helps prevent theft.

Lock the steering

1. Turn the handlebar all the way to the left.
2. With the key in the  position, push the key down and loose, then turn the key counter-clockwise to the  position.
3. Remove the key.



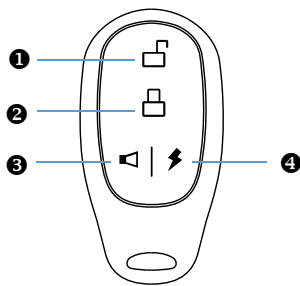

Unlock the steering

1. Install the key and turn clockwise.
2. Remove the key.

6.5 Remote controller



We use the advanced smart remote controller which can be easily locked or unlocked by pressing the button within 50 meters. The functions are as follows:

- ①  Unlock button: press this key, motorcycle unlocks, start/stop button flashes.
- ②  Lock button: when the motorcycle is stopped, press this key to lock the motorcycle.
- ③  Motorcycle search button: Press this button and the motorcycle will ring.
- ④  Start button: Double click this button to start the motorcycle.

6.6 Start/Stop button



Start/stop button is used to start or stop the motorcycle.

After unlocking the motorcycle through the smart remote controller, press the start button ① gently. The motorcycle enters the "start state". Press the button again to shut down the motorcycle.

When start/stop button is always on, it's the unlock state.

When start/stop button is flashing, it's the locked state.

6.7 Headlight Switch



Flip the switch upward to ☀, open the Headlight.

Flip the switch down to 🌙, open the Headlight.

6.8 Driving mode Switch



The driving mode switch ❶ is on the right handle switch.

Toggle between ECO, D(Dynamic), and S(Sport) modes.

The ECO selection reduces the acceleration and top speed of the motorcycle but increases the amount of regeneration when the throttle is released. It is an ideal mode for when you want softer acceleration. This position is also good for newer riders and for extending range.

The SPORT selection causes the motorcycle to accelerate at a significantly faster rate but decreases the amount of regeneration when the throttle is released. This position is recommended for advanced riders.

The Dynamic selection has a dynamic performance between the ECO and SPORT mode.

6.9 Emergency flasher switch



When the button ❶ is pressed, the turning lights flash to warn other drivers of situations, which include stop or park under emergency conditions.

Press the button again, and the hazard warning will turn off.

6.10 Headlight High/Low Beam Switch



The headlight high/low beam ❶ switch is on the left handle switch.

When the top of the switch is pressed, the headlight changes from low beam to high beam. It stays in the selected position until it is switched back. When in high beam position, the high beam indicator on the Speedometer illuminates.

6.11 Steering lamp switch



The steering lamp switch ❶ is on the left handle switch.

When the steering lamp switch is pushed in the left or right position, the corresponding front and rear steering lamp flash. When the steering lamp switch is ON, the corresponding steering lamp indicator on the speedometer illuminates.

Operate the signal lamp as required by law. Unlike a vehicle, the steering lamp must always be canceled manually on the motorcycle. Push the switch to the center position when you need to cancel the signal.

6.12 Horn Button



When the key is in the ON position, the horn sounds when the button ❶ is pressed. the horn can be used to warn pedestrians or other motorists of your presence.

6.13 Seat/helmet lock



The seat/helmet lock is located at the rear left side of the motorcycle.

Open the seat

Insert the key and turn clockwise. When you hear a click, grab the back of the seat and lift up.

Open the helmet lock

Insert the key into a counterclockwise rotation, then open the helmet lock, insert the helmet strap into it, then rotate clockwise to the starting position, and pull out the key.

6.14 Charging dock



The charging dock is in front of the seat. Press the back of the charging cover to open it.



The main circuit breaker ❸ is the protection switch of ES1 PRO main power supply. When the current caused by abnormal or short circuit of the motorcycle exceeds the safety setting value, the air switch will be automatically disconnected to ensure safety.

The USB port ❶ can output a stable 5V DC power supply, which can be used to charge your mobile device.

The battery charging port ❷ is used to charge the battery directly without removing the battery from the motorcycle.

6.15 Side stand



Side stand is located at left side of motorcycle.



Info

Please fold the side stand before you ride it.

7 Speedometer

7.1 Adjustment button



The adjustment button ② is located on the right back of speedometer ①. And it operates in two ways.

A short press indicates a light click of the button. Commonly used to switch menu values.

Long press means to hold this button for 2s. Commonly used to switch menu items.

7.2 Speed display

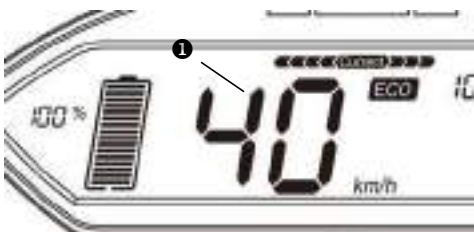

Display current speed.

7.3 Driving mode display

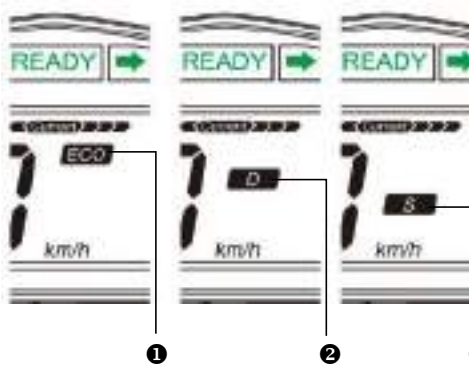

The riding mode is a shift switch located on the right-hand handle switch

- ECO ❶ economic mode
- D ❷ normal mode
- S ❸ motion mode

7.4 Current display



The current indication ❶ displays the real-time current in the form of a status bar. You can roughly determine the current real-time current through the status bar

When the status bar is full, the current is about 80Ah

7.5 Odometer

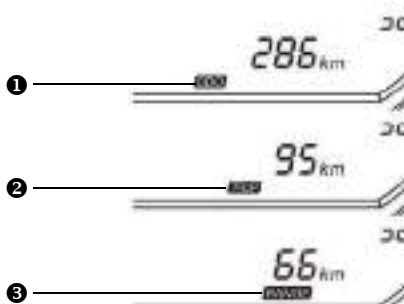

According to the mileage and time of your trip, the system will automatically remind you that gear oil in the reduction gearbox should be replaced. You can manually clear the reminder after changing the oil, or our service personnel can clear it for you.

- ❶ ODO: total mileage
- ❷ Trip: short range mileage
- ❸ Range: remaining mileage

7.6 Temperature display

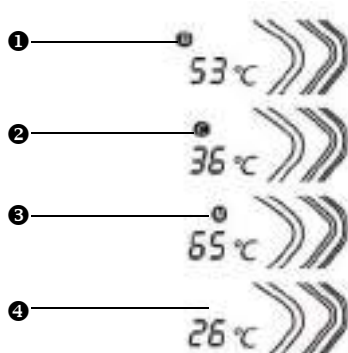

The system can display four temperatures, with "B" above the temperature display value indicating current battery temperature, "C" indicating current controller temperature, "M" indicating current motor temperature and no label indicating current external temperature.



Info

Press the rear button for 2 seconds. When one of ODO, TRIP or RANGE starts flashing, press it again for 2 seconds. Short press can switch between battery temperature, controller temperature, motor temperature and external temperature

Note: The temperature of the battery shall not be higher than 65 °C; the temperature of the motor shall not be higher than 120 °C, and the temperature of the controller shall not be higher than 80 °C

7.7 Battery display



① Display the battery capacity as a percentage.

② Display the battery capacity as an icon.

7.8 Charging indicator



During cycling, when you brake the vehicle, the controller recovers the braking energy. At the same time the charging symbol ① will light up.

7.9 Steering indicator



An arrow on the upper speedometer flashes green in the same direction as selected by the steering lamp switch. This remains flashing until the steering lamp request has been canceled.

7.10 READY indicator

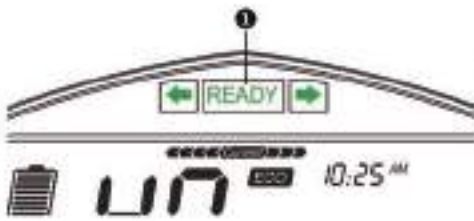

“READY”^❶ indicates that the HV system is connected and the motorcycle is ready to ride, while the speed is 0 km/h.

7.11 High beam indicator

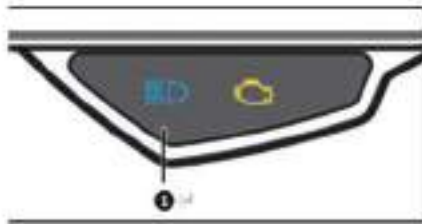

When the headlight high beam is on, this indicator ^❶ illuminates blue, and remains on until the high beam is turned off.

7.12 Parking indicator

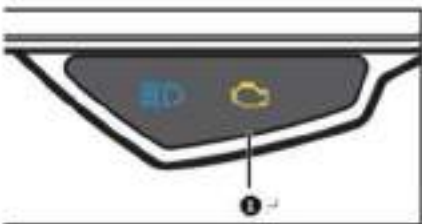

OBD trouble light When the OBD trouble light is on, it indicates that the vehicle has a running fault. Please go to the dealer for inspection.

info : When the vehicle is powered on for the first time, the OBD trouble light will work. After 3km riding, it will be out.

7.13 Error code indicator



When the error code indicator ^❶ turns on, it indicates a fault in the motorcycle. The error code is displayed in the odometer.

Method to view the error code

When the odometer is in odo mode^❷, press the adjustment button to enter Trip mode ^❸ and press the adjustment button again to enter range mode^❹. Press the adjustment button again to display the fault code.

The fault code will not be displayed immediately. You need to switch the mileage to Range display mode and press once more to display the fault code before the list.



Caution

Please stop immediately and check when this signal appears.

7.14 Time setting

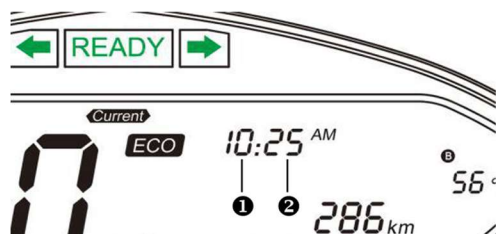

Press and hold the adjustment button at the back of the instrument panel, then switch on to enter the setting interface.

The hour of time will begin to flash. At this time, short press of the adjustment button can increase the number of hours, and the number will cycle within 0 and 23 hours.

After setting the hour, press the adjustment button again to switch to the modified minute position, and press the adjustment button again to increase the number of minutes, with the number cycling between 0 and 59.

The format can be switched between 12-hour format and 24-hour format.

7.15 Set the diameter of rear tire

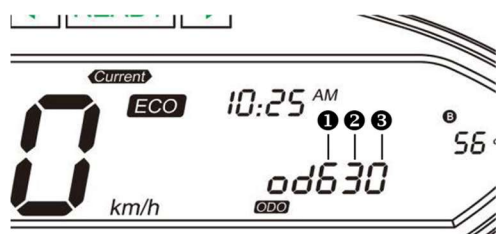

After setting the minute of the time, press the adjustment button again for a long time. The hundreds place ❶ of the front tire diameter will start flashing, and the short press will cycle between 0 and 9.

Press the adjustment button again for a long time, the tens place of the front tire diameter will start flashing, and the number will cycle between 0 and 9 with short press.

Press the adjustment button again for a long time, the front tire diameter digits will start flashing, and the number will cycle between 0 and 9 with short press.

7.16 Set the MM/INCH

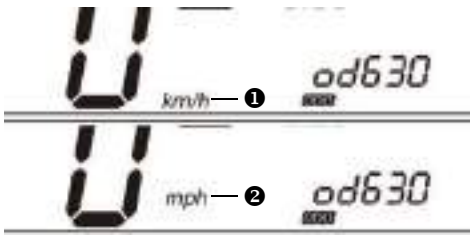

After setting the front tire diameter parameter, press and hold the adjustment button again to enter the MM/INCH setting.

At this time, km / h ❶ characters begin to flash.

Press the adjustment button briefly and mph ❷ character begin to flash, namely switching to INCH display mode.

7.17 Service indicator



According to the mileage and time of your trip, the system will automatically remind you that gear oil in the reduction gearbox should be replaced. You can manually clear the reminder after changing the oil, or our service personnel can clear it for you.



Info

When the total mileage reaches 1500 km, the oil symbol flashes for the first time. For every 3000 km of mileage accumulated in the future, the oil symbol will flash (4500 km for the second time, 7500 km for the third time, ..).

Elimination of oil symbol flashing: for normal display status, after pressing and holding the button (cannot enter this setting when the oil symbol does not flash), the wheel diameter display window displays OIL in the first three digits. The fourth digit from left to right does not display. And the last digit displays 0. After short press, inputting the number 3 and holding the button, the instrument restarts and the flash is eliminated.

8 How to drive this motorcycle

8.1 Checks and service when preparing for use



Info

Before each drive, check the condition of the motorcycle to ensure safe operation.

Before riding the ES1 PRO intelligent electric motorcycle, please check the following items, which will guarantee your safety on the road.

- Check whether the electrical system is working properly.
- Whether the battery power is sufficient.
- Whether the direction handle is stable and the rotation is flexible.
- Whether the switches on the left and right hand handles are working properly.
- Whether the speed grip works normally.
- Whether the brake oil quantity is sufficient and the handle and braking system are working properly.
- Check the front brake oil pipe.
- Check the rear brake oil pipe.
- Check the cleanliness of the chain.
- Check the chain tension.
- Check chains, front and rear sprockets and chain guides.
- To ensure normal tire pressure, recommended tire pressure (kPa) is :
(To ensure normal tire pressure, recommended tire pressure (kPa) refer to chapter 18.)
- Single person 225 / 225 (front / rear)
- Two person 225 / 250 (front / rear)
- Whether there is crack, damage, abrasion, foreign body puncture or adhesion on the tire surface.
- Whether the tread depth is enough and greater than 0.8 mm.
- If there is any fault warning light on the instrument panel after power-on.
- Whether the head and tail lights, brake lights and direction lights are working properly.
- Whether the horn is working properly.
- The rearview mirror is clean and adjusted to an appropriate angle.

Please contact KOLLTE Customer Service Center for any abnormalities or operational doubts.

8.2 Connect to the battery

This product supports the parallel connection of double batteries. The connection method for the battery is as follows:

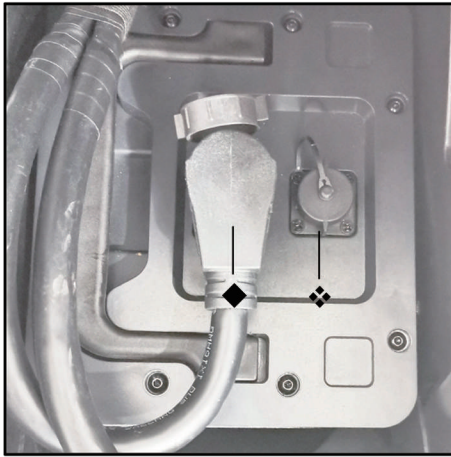

Use only one battery pack:

- Insert the connecting plug ◆ on the main wire bundle into the corresponding socket of the battery, and keep the waterproof cover on the interface ❖ of the battery in a tight state.



Caution

If the waterproof cover of the interface is not tight, the battery may be damaged by water.



Double-battery pack in parallel connection:

- When two battery packs need to be used in parallel with each other, the battery connecting line needs to be added so that the two batteries can communicate with each other.

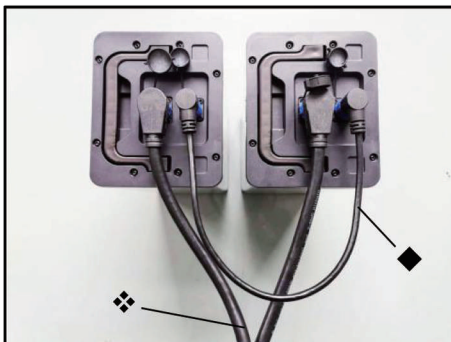

- The figure on the left is the schematic diagram of double-battery connection. First connect the two batteries with the battery connecting line, and then connect the two batteries respectively to the connector of the main wire bundle.

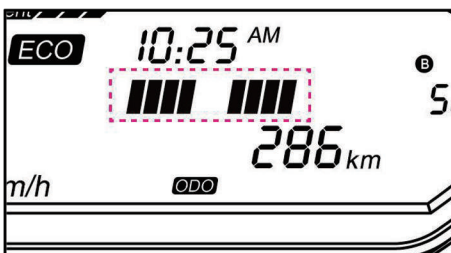

- The battery pack will decide whether to use in parallel according to its own situation. When two batteries are in parallel, the meter will display the parallel connection mark shown in the left picture.
- When this sign is displayed, it indicates that you can get more power and a higher speed.

8.3 Starting

This product can be started through three starting methods: key starting, remote control starting and one-key starting.



Info

Before driving, make sure all lines are connected correctly and the battery charging and discharging ports are connected with cables.

Check whether the air switch is on.

1) Use the key

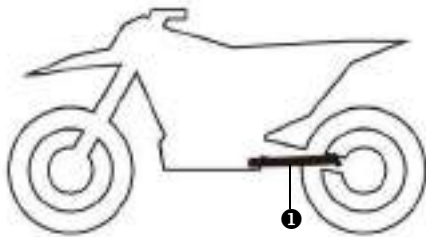

- Fold the side stand.
- Insert the key into the ignition lock and screw it into \odot position.
- The motorcycle starts with a "drip" sound

2) Use remote controller

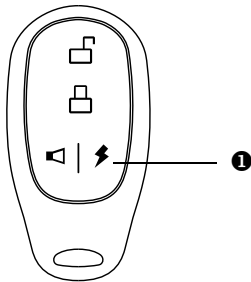

- Click the remote start button **1** twice in a row.
- The motorcycle starts with a "drip" sound

3) Start with one key

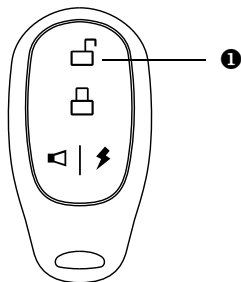

- Use the remote controller's unlock key **1** to unlock the motorcycle



- At this time, the indicator light in the start-stop button **2** is flashing.
- Tap the start/stop button.
- Motorcycle starts

8.4 Starting off



info



- Select the driving mode switch on the right-hand handle switch. There are three modes for selection.
 - Eco (Economic Mode) Halve the motor output torque and revolving speed.
 - D (Standard Mode) Normal running mode.
 - S (sport mode) Increase motor power by 20 %.
- Turn the throttle grip carefully and the motorcycle starts.

8.5 Braking



Warning

Excessively forceful application of the brakes blocks the wheels.



Warning

A spongy pressure on the front or rear brake reduces braking efficiency.

– Check the braking system and do not continue driving until the problem is eliminated.



Warning

Moisture and dirt impair the braking system.

– Brake carefully several times to dry out and remove dirt from the brake linings and the brake discs.



Info

The rear brake handle is located on the left side of the steering handle

- When braking, please release the Throttle grip and operate the front and rear brakes at the same time.
- Rear tire brakes should be mainly used when driving on sandy, waterlogged or smooth ground.
- Please brake in advance when entering the curve.

8.6 Stopping, parking



Warning.

Danger of theft Used by unauthorized personnel.

Never park your motorcycle unattended.

Prevent unauthorized personnel from contacting the motorcycle.



Warning

Danger of scalding

Some parts of the motorcycle have quite high temperatures during operation.

Do not contact high temperature parts such as motors, shock absorbers and braking systems.

Allow the parts to cool before starting work on them.



Note

The parked motorcycle may slide or tip over.

Always park the motorcycle on a stable and flat ground.



Note

Some parts of the motorcycle have quite high temperatures during operation.

Do not park your motorcycle in a location with flammable and / or combustible materials.

Do not place objects on motorcycles that have reached operating temperatures. The motorcycle must be cooled first.



Note

The side stand is only designed for bearing the weight of the motorcycle. Please don't sit on the motorcycle when you park it by the side stand. Otherwise, the side stand or chassis may

be damaged and the motorcycle may tip over.

Brake motorcycle to stop.

Shut down the motorcycle.

Park the motorcycle on a solid ground.

8.7 Shutting down the motorcycle

- Use the key to shut down
- If you use the key to start the motorcycle, you shall also use the key to shut down the motorcycle.
- Turn the key to the  position and the motorcycle is shut down .
- Lock the head.

2) Use the start-stop button to shut down

- Before using the start-stop button to lock the motorcycle, the motorcycle must be stopped first.
After pressing the start-stop button, the motorcycle will be shut down.

2) Shut down with the remote controller

- Press and hold the lock key  until the motorcycle is shut down.

8.8 Transporting the motorcycle

- Closing the motorcycle. (see previous section)
 - Secure the motorcycle with a fastening tape or other suitable fixing device to prevent tipping and sliding.
-



Warning

Danger of scalding Some parts of the motorcycle have very high temperatures during operation.

Do not contact high temperature parts such as motors, shock absorbers and braking systems.
Allow the parts to cool before starting work on them.



Note

The parked motorcycle may slide or tip over.

Always park the motorcycle on a stable and flat ground.

8.9 Transporting the battery

Secure the battery pack with a fastening tape or other suitable fixing device to prevent tipping and

sliding



Warning

The battery pack is a very important part

- Appropriate protective measures should be taken during transportation, otherwise serious injury will be caused.
- If proper protective measures are not provided, the transport motorcycle may be damaged.

9 Service schedule

Regular service can improve the service life and driving safety of the ES1 intelligent electric motorcycle. It is recommended that you refer to the following suggestions to take care of your car.

9.1 Required work

The new motorcycle must be inspected and maintained for the first time at KOLLTER Service Center 1,500 kilometers or two months after delivery, whichever comes first.

It is recommended that regular inspection and service be conducted at KOLLTER Service Center every 3,000 kilometers or every six months (whichever comes first).

	Every 3000km (1864mi)	
	The first 1500km (932mi)	
Check whether the electrical system is working properly.	<input type="radio"/>	<input checked="" type="radio"/>
Check the rechargeable battery pack.	<input type="radio"/>	<input checked="" type="radio"/>
Whether the direction handle is stable and the rotation is flexible		<input checked="" type="radio"/>
Whether the switches on the left and right handles are working properly		<input checked="" type="radio"/>
Whether the brake oil quantity is sufficient and the handle and braking system are working properly.		<input checked="" type="radio"/>
Check the front brake oil pipe.		<input checked="" type="radio"/>
Check the rear brake oil pipe.		<input checked="" type="radio"/>
Check the cleanliness of the chain.		<input checked="" type="radio"/>
Check the chain tension.		<input checked="" type="radio"/>
Check chains, front and rear sprockets and chain guides.		<input checked="" type="radio"/>
To ensure normal tire pressure, recommended tire pressure (KPa) is:		
Single person 225 / 225 (front / rear)	<input type="radio"/>	<input checked="" type="radio"/>
Two person 225 / 250 (front / rear)		

	Every 3000km (1864mi)	
	The first 1500km (932mi)	
Whether there is any crack, damage, abrasion, foreign body puncture or adhesion on the tire surface.	○	●
Whether the tread depth is enough and greater than 0.8 mm.	○	●
If there is any fault warning light on the instrument panel after power-on.		●
Whether the head and tail lights, brake lights and direction lights are working properly.		●
Check whether the horn is working properly.		●
The rearview mirror is clean and adjusted to an appropriate angle.		●

○ One-off cycle

● Periodic cycle

9.2 Recommended inspection

	Every 2 years	
	Every 6000 km(3728mi)	
	Every 3000 km(1864mi)	
Replace the front brake fluid		●
Replace the rear brake fluid		●
Lubricate directional column bearings		●
Front suspension maintenance		●
Rear cushion maintenance		●
Replace gear oil	●	●
Check the cradle bearing	●	●

● Periodic cycle

10 Motorcycle adjustment operation

10.1 Adjustment of rebound damping of front shock absorber



- The hydraulic rebound damping system determines the performance of the front suspension when it bounces up.
- The adjusting bolt ❶ is located at the upper end of the front suspension leg.
- Screw the adjusting bolt to the end.
- Rotate counterclockwise, the number of rotations depends on the type of front suspension.

Requirement

Rebound damping	
Comfortable	18 clicks
Standard	12clicks
Sport	6clicks



Info

When the spring bounces up, rotating in the clockwise direction can improve the shock absorption effect and rotating in the counterclockwise direction can reduce the shock absorption effect.

10.2 Adjusting the spring preload of the rear shock absorber



Main Work:

- Loosen nut ❶
- Turn adjusting ring ❷ until the spring is no longer under tension
- Measure the overall spring length while the spring is not under tension
- Tighten the spring by turning adjusting ring ❷ to the specified value A
- Requirement

Spring preload A	
Comfort	8 mm
Standard	7 mm
Sport	9 mm

- Tighten nut ❶.



Warning

The rear shock absorber contains highly pressurized gas.

- Do not attempt to tamper with or open the cylinder of shock absorber.
- Do not subject the shock absorber to high temperature or open flame.

10.3 Checking the chain tension



Warning

Danger of accidents Danger caused by incorrect chain tension.

- If the chain is over tightened, the components of the secondary power transmission (chain, chain pinion, rear sprocket, gear case, bearings in the rear tire) will be under additional load. In addition to premature wear, this can cause the chain or the countershaft of the transmission to break in extreme cases. If the chain is too loose, it may fall off the chain pinion or rear sprocket and block the rear tire or damage the motor. Ensure that the chain tension is correct and adjust it if necessary.

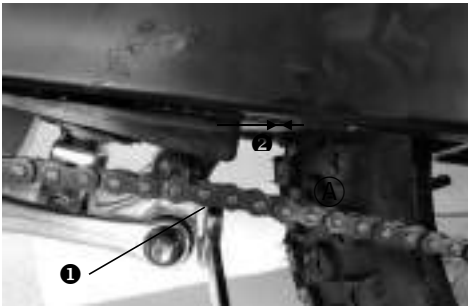

Push the chain at the lower end of the chain support ❶ upward to check the tension of the chain between the chain and the chain support.

Chain tightnessⒶ	0-5 mm
------------------	--------

If the chain tension does not conform to the regulations.

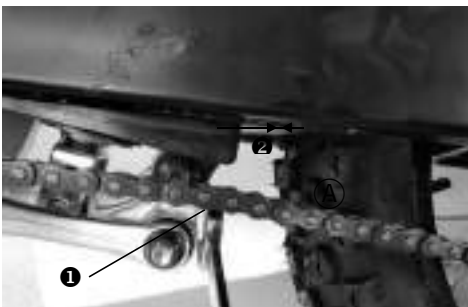

- Adjust the chain tension.

10.4 Adjusting the chain tension



Warning

- **Danger of accidents** The wrong chain tension may lead to danger.
- If the chain is stretched too tightly, it will place an additional burden on the components of the secondary transmission (chain, engine sprocket, rear sprocket, gearbox and bearings in the rear tires). In addition to causing premature wear, in extreme cases the chain may wear out or the output shaft of the gearbox may break. On the contrary, if the chain is too loose, it may fall from the drive sprocket teeth or the rear sprocket and cause the rear tire to lock or damage the motor. Observe the correct chain tension and adjust it if necessary.

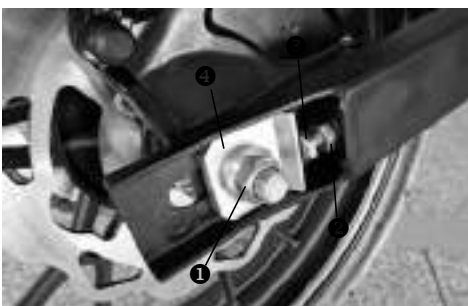

Preliminary work

- Hold up the motorcycle with a lifting chassis
- Check the chain tension.

Main work

- Loosen the rear axle nut ❶.
- Loosen the nut ❷.
- Adjust the chain tension by rotating the left and right adjusting bolts ❸

Requirement

Chain tension	0-5 mm
<p>Rotate the left and right adjusting bolt ❸ to ensure the relative positions between the marks of the left and right chain tensioners ❹ and the reference marks are the same. This indicates that the rear tires have been correctly calibrated.</p>	

- Tighten the nut ❷
- Make sure that the chain tensioner ❹ abuts on the adjusting bolt ❸ on
- Tighten the nut ❶.

Requirement

Rear axle nut	90 Nm
---------------	-------

Finishing

- Remove the motorcycle from the rear tire support.

10.5 Checking chain dirt accumulation



- Check whether the chain has serious dirt accumulation
 - » If the chain has serious dirt accumulation:
Clean the chain.

10.6 Clean the chain



- Lift the motorcycle with the rear tire support
- Clean the chain regularly.
- Rinse large pieces of dirt with soft water.
- Use chain cleaner to remove used lubricant residues.
- Spray chain spray after drying

11 Braking system

11.1 Checking the brake disc

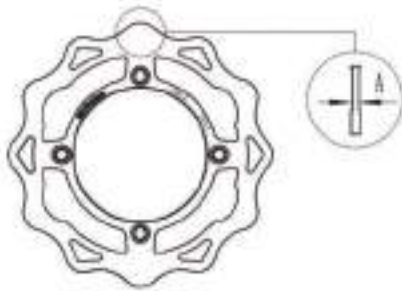

- Check the thickness A of the brake disc.

Front brake disc	≥ 3 mm
Rear brake disc	≥ 3 mm



Warning

Worn-out brake discs reduce the braking effect.

- Make sure that worn-out brake discs are replaced as soon as possible. (Your authorized workshop will be glad to help.)

11.2 Check the brake lining



Warning

Worn-out brake linings reduce the braking effect.

- Make sure that worn-out brake linings are replaced as soon as possible. (Your authorized workshop will be glad to help.)

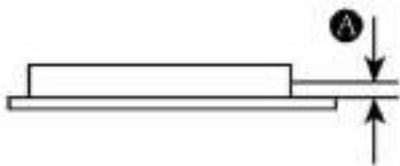

- Observe the lining from the top or rear of the pump under the rear disc brake. Visually inspect the minimum thickness A of the brake lining.

Minimum thickness A of brake lining	$\geq 1 \text{ mm}$
-------------------------------------	---------------------

» If the minimum thickness of the lining is less than the specified value:

Please replace the brake linings.

- Check whether the brake lining is damaged or cracked.
 - » If there is any damage or crack, please replace the brake lining.

11.3 Checking the brake fluid



Warning

- Lack of brake fluid will cause the braking system to fail.
- If the brake fluid level drops below the specified marking or the specified value, the braking system is leaking or the brake linings are worn down.
- Check the braking system and do not continue riding until the problem is eliminated. (Your authorized workshop will be glad to help.)



Warning

- Overuse of brake fluid reduces the braking effect.
 - Make sure that brake fluid for the front and rear brake is changed in accordance with the service schedule. (Your authorized workshop will be glad to help.)
-



Warning

- Brake fluid may cause skin irritation.
 - Keep brake fluid out of the reach of children.
 - Wear suitable protective clothing and safety glasses.
 - Do not allow brake fluid to come into contact with the skin, the eyes or clothing.
 - Consult a doctor immediately if brake fluid has been swallowed.
 - Rinse the affected area with plenty of water in the event of brake fluid contacting with the skin.
 - Rinse eyes thoroughly with water immediately and consult a doctor if brake fluid comes into contact with the eyes.
 - If brake fluid spills onto your clothing, change the clothing.
-



- Place the brake fluid cup installed on the directional handle in a horizontal position.
- Check the brake fluid level through the oil cup.
 - » When the brake fluid level drops below the MIN mark:
Replenish brake fluid for front tire brake.

12 Wheels, tires

12.1 Checking the status of wheels and tires

- Inspect both wheels for the following:
 - » Bent, loose, or missing spokes.

- » Bent or cracked rims.
 - » Impact marks on the rims.
- Inspect both tires for the following:
- » Cuts, cracks, splits, or missing tread lugs on the tread or sidewall area.
 - » Bumps or bulges on the tire body.
 - » Uneven tire tread wear. Wear on one side of the tire tread or flat spots in the tire tread indicate problems of the tire or motorcycle.
 - » Exposed tire thread or cords.
- If either the wheel or the tire is found to have any of the above conditions, replace the wheel and tire immediately.

12.2 Checking the tire pressure



Warning

- Under-inflation is a common cause of tire fault and may result in severe tire cracking, tread separation, “blowout,” or unexpected loss of motorcycle control, causing serious injury or death.

- Tire pressure should be checked and adjusted to the proper inflation levels before each ride. Tire pressure should be checked using an accurate gauge when the tires are cold. This means that the tires have not been ridden on for at least 3 hours. Always replace the air tap cap after adjusting tire pressures.

Model	Front tire	Rear tire
ES1-S PRO	225 kPa	235 kPa
ES1-X PRO	200 kPa	210 kPa

13 Battery

13.1 Install the battery



Caution

- You must leave your motorcycle on the charger if you expect it to sit in storage or unused for over 90 days.

-
- Steps to install the battery pack.

- » Hold up the motorcycle with the side stand.
- » Open the seat cushion with the key.
- » Pick up the battery and place it in the battery compartment. Pay attention to the arrow above the battery when placing it.
- » Insert discharge plug and charging plug.

13.2 Removing the battery

- Steps to install the battery pack.

- » Hold up the motorcycle with the side stand.
- » Unplug the discharge plug and charging plug.
- » Lift the battery out of the battery compartment.

13.3 Battery charging



- Caution

- The power pack must be charged within 24 hours if is fully discharged, and shall be charged within 90 days after it is fully charged.

-
- We recommend you plug in your ES1 PRO after 90 days. Even if it is fully charged, please leave your ES1 PRO plugged in whenever possible.
 - The power pack is a lithium-ion power system. While it does require charging, it does not require maintenance.
 - The power pack should be kept away from excessive heat. The temperature of lithium-ion cells should not be above 65 °C. It shall not be stored in a hot trailer or be placed under direct sunlight.

- Only the authorized service agent is qualified to unpack the power pack.
- Dispose of the power pack according to your state and local laws. It is encouraged that the power pack be recycled rather than disposed of in landfills.
- Please contact us via info@tinbot-tech.com or contact the recycling center in your area.

Motorcycle charging



Preparatory work

- Stop the motorcycle on the flat ground.
- Shut down the motorcycle.

Main work

- Insert the charger charging plug into the charging port first.
- Plug the AC power plug of the charger into the mains socket, and the charger will display a red light indicating that it is charging.
- The charger indicator turns green, indicating that the battery is fully charged.



External charging



Preparatory work

- Stop the motorcycle on the flat ground.
- Shut down the motorcycle.
- Take out the battery

Main work

- Insert the charger plug into the charging port of the battery pack first.
- Plug the AC power plug of the charger into the mains socket, and the charger will display a red light indicating that it is charging.

- The charger indicator turns green, indicating that the battery is fully charged



- Warning

- Pay attention to water resistance to prevent the battery pack from being drenched and invaded by water;
 - Operating temperature during charging: 0-45 °C, operating temperature during discharging:
 - 20 - 65 °C;
 - The battery pack should be charged as soon as it is used. When it is not used for a long time, it must be removed from the motorcycle and stored.
 - It is strictly prohibited to short-circuit the positive and negative poles of the input and output terminals of the battery pack;
 - Keep the battery pack away from children, fire sources and heat sources, and do not throw it into the fire.
 - Strenuous exercise, impact and extrusion should be avoided;
 - The designated special charger must be used. It is forbidden to charge the battery pack with other chargers.
 - This product has been strictly inspected before leaving the factory, and it is strictly prohibited to disassemble it without permission. In case of any problems, please contact our after-sales service department. .
-

14 Service for the Motor

14.1 Checking the gear oil



Preparatory work

- Stop the motorcycle on the flat ground.
- Shut down the motorcycle.

Main work

- Rotate the oil gauge ① and use a paper towel to clean the oil stains on it.
- Insert the oil gauge again, but do not screw in it.
- Check the oil level.
 - » If the oil level is below the oil gauge grid area ②: Replenish gear oil.
 - » If the oil level is above the oil gauge grid area ②: Adjust gear oil.



14.2 Changing the gear oil



Warning

- Gear oil becomes very hot when the motorcycle is operating.
- Wear suitable protective clothing and safety gloves.
- If you have been scalded, irrigate the burn with lukewarm water immediately.



Preparatory work

- Stop the motorcycle on its side stand on a flat ground.
- Shut down the motorcycle.

Main work

- Place a suitable container under the motor.

- Remove oil drain bolt.
- Remove the oil gauge.
- Let the gear oil drain fully.
- Mount and tighten the oil drain bolt.

Oil drain bolt	M10x1.5x16	20N.m
----------------	------------	-------

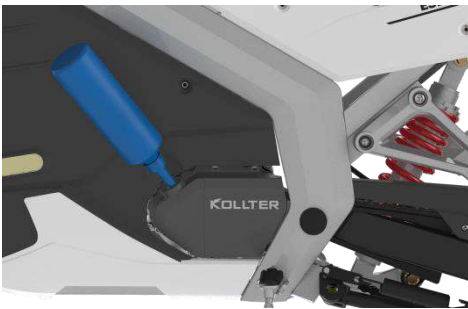

- Fill gear oil 0.35 L with special oil pot.
- Clean the oil splashed on the outside surface.
- Install and tighten the oil gauge

15 Cleaning and service

15.1 Cleaning the motorcycle

Cleaning: clean the motorcycle with clean water and neutral lotion. Clean the surface with soft cloth and sponge; it is strictly prohibited to use metal brushes and sandpaper to clean, so as not to scratch the surface of parts. After cleaning, dry the motorcycle with a soft cloth.



Note

Please disconnect the main circuit breaker before you clean the motorcycle.

Do not flush the motorcycle with strong water stream directly, so as to avoid machine parts fault due to water and gas invasion.



Note

If you clean the motorcycle regularly, its value and appearance will be maintained over a long period.

Avoid direct sunshine on the motorcycle during cleaning.

15.2 Inspection and service for use during winter



Note

- If the motorcycle is used in the winter, the case that salt is sprinkled on the roads for snow melting should be taken into consideration. Precautions need to be taken against corrosive salt for snow melting.
- If the motorcycle runs on the road with salt for snow melting, it is necessary to clean the motorcycle with cold water after riding. Warm water would enhance the corrosive effects of salt.



- Clean the motorcycle.
- Clean the braking system.



Note

- After riding on the road with salt for snow melting, thoroughly wash the brake calipers and brake linings with cold water and dry them carefully. This should be done after the parts are cooled down and while they are installed.
- After riding on the road with salt for snow melting, thoroughly wash the motorcycle with cold water and dry it well.
- Treat the motor, swing arm, and all other exposed and zinc-plated parts (except for the brake discs) with wax-based corrosion inhibitor.



Note

- Corrosion inhibitor is not allowed to contact with the brake discs as this would greatly reduce the braking force.

- Clean the chain.

16 Storage

16.1 Storage

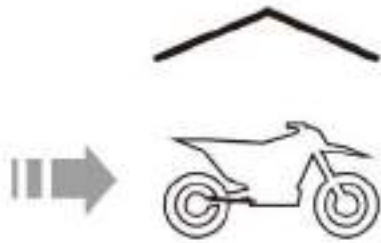

- The motorcycle shall be stored in a dry and cool room as far as possible to reduce sun exposure and rain, so as to avoid reduction of service life due to corrosion of parts.
- When storing the motorcycle for a long time, please shut down the air switch and disconnect the battery power supply circuit to prevent the battery from discharging excessively.
- After long-term storage, please fully charge the battery before use.
- When the battery pack needs to be stored for a long time, please charge the battery pack to a semi-saturated state (after the battery pack is discharged, charge it for 3 hours). Place it in a dry and ventilated place and charge it for 2 hours every two months.
- Battery packs and chargers should be stored in a clean, dry and ventilated place. Avoid contact with corrosive substances and keep away from power and heat sources;
- Storage conditions of battery pack: ambient temperature - 20 - 35°C, ambient humidity $\leq 65\%$;
- Disconnect the battery pack when storing the charger.

16.2 Preparing for use after storage



Info

If the battery pack has not been used for more than six months, start the motorcycle and discharge the battery pack until it is used up. Then recharge the battery pack completely.

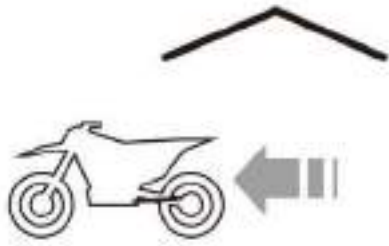

- Install the battery pack.
- Turn on the power.
- Implement inspection and service measures.
- Try riding

17 Troubleshooting

Fault phenomenon	Cause of fault	Solution
The motorcycle is not powered on and the start / stop button is not on	1) The battery connection is not in place 2) The air switch is not on	1) The battery main plug is connected in place 2) Turn on the air switch
After electrifying, turn the speed regulating grip and the motor does not rotate	1) Insufficient battery power 2) Side stand is not folded 3) The parking key is not closed 4) Brake handle does not return in place 5) Grip fault 6) Controller plug is loose 7) Controller fault	1) Charge the battery 2) Fold the kick stand 3) Close the parking key 4) Brake handle returns to original position 5) Replace the grip 6) Reseat the controller plug-in 7) Replace the controller
The driving speed is slow or the driving mileage is short	1) Insufficient battery power 2) Insufficient tire pressure 3) Serious overload 4) Brake pad interference 5) Battery aging or normal scrap	1) Recharge the battery 2) Replenish the tire pressure and check the tire pressure before each ride 3) Develop good habits and keep proper load 4) Change the brake pads and check the braking system before each ride 5) Replace the battery
The battery cannot be charged	1) Poor contact of charging main plug 2) Wrong charger 3) Battery aging or normal scrap	1) Check whether the main plug is plugged in place 2) Use KOLLTER special charger 3) Replace the battery
Fault code11	Controller communication fault	Please contact your after-sales service or dealer
Fault code12	Controller suspends operation (overcurrent)	Please stop for a while before starting
Fault code13	The controller is suspended (rotation is blocked)	Please stop for a while before starting
Fault code14	The controller is suspended	Please stop for a while before starting

	(undervoltage or overvoltage)	
Fault code15	Controller suspends operation (over temperature)	Please stop for a while before starting
Fault code16	Power tube fault, drive power fault	Please contact your after-sales service or dealer
Fault code17	Controller verification fault, illegal controller and controller fault	Please contact your after-sales service or dealer
Fault code21	Motor fault, HALL fault, lack of phase	Please contact your after-sales service or dealer
Fault code21	Overcharge protection warning	Please stop charging and check the charger
Fault code32	Charging overcurrent protection warning	Please stop charging and check the charger
Fault code33	Charging overvoltage protection	Please stop charging and check the charger
Fault code34	Charging is prohibited at low temperature (below 0 °C for 30s and below - 20 °C for 3s)	The motorcycle was pushed indoors or in a warm place and waited for a moment
Fault code35	Over-release protection warning	If 35 is always displayed, please stop riding
Fault code36	Discharge overcurrent protection warning	Please stop charging and check the charger
Fault code37	Battery overheat protection warning	Please stop for a while before starting
Fault code38	Battery supercooling protection	Stop the motorcycle indoor or in a warm place and wait for a moment
Fault code39	BMS communication fault	Check whether the charging interface is connected properly and contact the after-sales service or dealer
Fault code40	Battery short circuit protection warning	Please contact your after-sales service or dealer
Fault code41	Other abnormal battery warnings	Please contact your after-sales service

	(battery open circuit / battery differential voltage greater than 0.3V)	or dealer
Fault code51	Communication bus fault	Please contact your after-sales service or dealer
Fault code61	Grip fault	Please check the grip line or replace it at the after-sales service center

18.1 Motor

Motor type	Permanent magnet synchronous motor
Rated power	5 kW
Maximum power	11 kW
Maximum torque	370 N.m
Maximum speed	6000 rpm
Primary transmission ratio	1:2
Cooling mode	Natural air cooling
Gear oil grade	Gear oil (SAE 85W/90)
Gear oil capacity	0.35L

18.2 Complete motorcycle

Overall size	
Motorcycle profile dimensions	ES1-S PRO : 2080 mm x 860 mm x 1100 mm
	ES1-X PRO : 2080 mm x 860 mm x 1150 mm
The minimum ground clearance	ES1-S PRO : 280 mm ES1-X PRO : 320mm
Seat cushion height	ES1-S PRO : 820 mm ES1-X PRO : 860 mm
Speed	
Top speed(two batteries paralleled)	96km/h
Top speed (one battery)	80km/h
Quality	
The mass of the a group of battery of the motorcycle	109 kg
Maximum allowable load mass of front tires	108 kg
Maximum allowable load mass of rear tires	162 kg
Maximum allowable load mass of the motorcycle	270 kg
Frame	
Frame	Carbon steel
Head pipe angle	25°
Suspension	
Front suspension stroke	ES1-S PRO : 130 mm ES1-X PRO : 170 mm

Rear suspension stroke	ES1-S PRO : 130 mm ES1-X PRO : 170 mm
Braking system (CBS)	
Front braking system	Disc brake (double-piston pliers)
Rear braking system	Disc brake (single-piston pliers)
Front brake disc diameter	300 mm
Rear brake disc diameter	220 mm
Minimum thickness of front brake disc	3 mm
Minimum thickness of rear brake disc	3 mm
Tire	
Front tire size	ES1-S PRO : 110/70-17 or 100/80-17 ES1-X PRO : 3.00-21
Rear tire size	ES1-S PRO : 120/70-17 ES1-X PRO : 4.10-18
Front tire pressure	ES1-S PRO : 225 kPa ES1-X PRO : 200 kPa
Rear tire pressure	ES1-S PRO : 235 kPa ES1-X PRO : 210 kPa
Transmission	
Secondary transmission ratio	1:3.9
Chain specification	428H
Number of teeth of small sprocket	13
Number of teeth of large sprocket	51

18.3 Electrical System

Lithium battery	
Nominal voltage	72 V
Voltage under full charge	84 V
Capacity	31.5 Ah (2.27 kWh)
Weight	12.3 kg
Charger	
Input AC voltage	100 ~ 230 V
Power	500 W, 1500 W (optional)

Output voltage	84 V
Voltage converter output fuse	10A
USB charger fuse	5A
Battery specification of remote controller	CR 2032
Front headlight	LED 24W
Steering lamp	LED
Rear tail lamp	LED
Rear license plate lamp	W5W 12V 5W

