

Two-wheeled Motorcycle Instruction Manual Third Edition (September 2021)

The copyright of this instruction manual belongs to the company, and it is not allowed to reprint without the written consent of the company. The contents and pictures in the instruction manual are for reference only, please refer to the actual product.

First of all, congratulations on purchasing a brand new motorcycle!

When you choose Excelle motorcycle products, you become a member of the Excelle motorcycle family.

This manual introduces the main specifications, basic structure, adjustment methods and maintenance knowledge of this vehicle. This manual will guide you to master the basic operation methods of the vehicle and the ability to eliminate common faults, which can effectively ensure driving safety, reduce motorcycle failures, exert the best performance of the vehicle, and improve the service life of the vehicle.

The content of this manual contains the introduction of the basic configuration of this vehicle. Due to the factory time, user needs and design improvements, the actual vehicle may be slightly different from the content of this instruction manual. We apologize for any inconvenience caused.

This instruction manual is one of the necessary accessories for this car. When this car is resold to others, it should be attached with the car.

To ensure your safety and increase your driving pleasure:

- Please read this manual carefully.
- Follow all recommendations and procedures in this manual.
- Please pay close attention to the safety information recorded in this manual and affixed to the motorcycle body.

Safety Precautions

Your and others safety is very important and riding this motorcycle safely is an important responsibility.

To help you make an informed decision about safety, we provide instructions and other information on the safety label and in this manual to alert you to potential hazards that may harm you or others.

Of course, it would be impractical or impossible for us to list all the hazards associated with motorcycle riding and maintenance, and you would have to judge correctly for yourself.

It is forbidden to add electrical equipment, because the battery used in this car is lithium battery, the battery capacity is small, if added electrical equipment may lead to power loss.

You will see important security information in various forms, including:

- Safety label on motorcycle body;
- Safety information, with a safety warning symbol  and one of the following three warning: Danger, warning, caution.

The meanings of the three warnings are as follows:

 **DANGER** — Failure to follow instructions could result in serious injury or death

 **WARNING** — Failure to follow instructions could result in serious injury or death

 **CAUTION** — If you don't follow the instructions, you may get hurt

Other important information is listed below the following headings:

CAUTION Information to help you avoid damage to motorcycles, other property or the environment.

CONTENTS

Motorcycle Safety	5
Instructions	17
Maintenance	27
Troubleshooting	53
Related Information	65
Technical Parameter	75

Motorcycle safety

This section contains important information about safe motorcycle riding. Please read this section carefully

Safety Guidelines	5
Safety Precautions	8
Riding Precautions.....	9
Accessories and Modifications	13
Loading Guideline	14

Safety Guidelines

To ensure your riding safety, please follow these guidelines:

- Perform all routine and routine inspections specified in this manual.
- Extinguish the engine before filling the tank and keep away from sparks and open flames.
- Do not start the engine in a confined or semi-confined space because carbon monoxide in the exhaust gas is toxic and can be fatal.

Always wear a helmet

Helmets and protective clothing have been shown to significantly reduce the chance and severity of head and other injuries. Therefore, be sure to wear a certified motorcycle helmet and protective clothing at all times.

Before riding

Make sure you're in good shape, focused, and not drinking or taking drugs. Ensure that you and your companion wear a certified motorcycle helmet and protective clothing. Instruct your companion to hold on to the rear handrail or hold on to your waist, lean in with you as you turn, and place your feet on the pedals, even when the bike comes to a stop.

Take time to learn and practice

Even if you have ridden other motorcycles, practice riding the motorcycle in a safe area to become familiar with the operation and operation of the motorcycle and get used to its size and weight.

Be protective when riding

Keep an eye on the cars around you and don't assume other drivers can see you. Always be prepared to brake or avoid a detour.

Make yourself more eye-catching

Especially at night, wear bright reflective clothing to make yourself stand out, park in a position where other drivers can see you, signal before turning or changing lanes, or honk to alert pedestrians if

Don't drink and drive

Never ride beyond your personal capacity or faster than conditions permit. Fatigue and inattention can impair your ability to make good judgment and ride safely.

Keep your car safe

It is important to maintain your motorcycle properly and keep it in good condition at all times. Inspect your motorcycle before each ride and complete all recommended upkeep and maintenance. Overload is strictly prohibited. Do not modify the motorcycle or install parts that will affect safety.

Handling unexpected incidents

Personal safety is your number one priority. If you or anyone else is injured, you should carefully assess the severity of the injury and determine whether it is safe to continue riding. Call for emergency assistance if necessary. If a collision involves other people or vehicles, applicable laws and regulations should also be followed.

If you decide to continue riding, first turn the ignition switch  to the (off) position and then evaluate the condition of the motorcycle. Check for oil leaks, check critical nuts and bolts for tightness, and check handlebars, steering column, brakes and wheels. Please ride slowly and carefully. Your motorcycle may have suffered damage that is not immediately apparent, please take it to a service shop or qualified repair shop as soon as possible for a thorough inspection.

Carbon Monoxide Hazard

Exhaust air contains toxic carbon monoxide. Carbon monoxide is a colorless, odorless gas, and inhaling carbon monoxide can cause unconsciousness and can even be fatal.

If you start the engine in an enclosed or semi-enclosed space, the air you breathe in may contain dangerous amounts of carbon monoxide.

Never start the engine in a garage or other confined space.



WARNING

Starting a motorcycle engine in a confined or semi-confined space can cause a rapid build-up of toxic carbon monoxide gas.

Inhaling the odorless, colorless gas can cause rapid loss of consciousness and death.

Only run your motorcycle engine in a well-ventilated outdoor area.

Safety Precautions

- Ride carefully, always keep your hands on the handlebars and feet on the pedals.
- Make sure to hold on to the rear handrail or hold your waist and put your feet on the pedals during driving.
- Be aware of the safety of your companion and other drivers and riders on the road at all times.

protective suit

Make sure that you and any accompanying passenger wear a certified motorcycle helmet, goggles and eye-catching protective clothing. Ride carefully according to weather and road conditions.

! Helmet

Certified to safety standards, eye-catching, and sized to fit your head.

- It must be secure and comfortable and secured with a chin strap.
- Face masks or other approved goggles that do not obstruct vision.

! Gloves

High wear resistant and all - finger leather gloves.

! Boots or riding shoes

Boots that are strong and non-slip and protect the ankle.

! Clothing

A bold, long-sleeved protective shirt and durable trousers (or protective suit) suitable for riding.



WARNING

Not wearing a helmet increases the chance of serious injury or death in a crash.

Make sure you and as a person always wear certified helmet and protective clothing.

Riding Precautions

Run-in Period

Follow these guidelines for the first 500km to ensure reliability and performance for the rest of your motorcycle.

- Avoid full throttle start or rapid acceleration.
- Avoid emergency braking and quick downshifts.
- Ride carefully.

Brake

Follow these guidelines:

- Avoid excessive emergency braking and gearshifting.
 - ▶ Sudden braking can reduce the stability of a motorcycle.
 - ▶ If conditions permit, slow down before turning, or you risk slipping and falling.
- Be careful when driving on wet roads.
 - ▶ Tires glide more easily on this kind of surface, requiring longer braking distances.
- Avoid continuous braking.
 - ▶ In the case of long and steep slope downhill, repeated braking can cause the brakes to overheat severely, affecting the braking effect. With the help of engine brakes, the brakes should be used intermittently to decelerate.
- The full braking effect can be achieved with the simultaneous use of the front and rear brakes.

I (ABS)

This model is equipped with an anti-lock braking system to prevent brake lock-up conditions that occur during emergency braking.

- Anti-lock braking systems do not reduce braking distance.

In some cases, antilock braking systems may result in longer parking braking distances.

- The speed is below 10 km/h, antilock braking system is not working.
- The brake lever and pedal may rebound slightly during braking. This is a normal phenomenon.
- Always use the recommended tires to ensure that antilock braking works properly.

I Engine Braking

When you release the throttle, engine braking helps slow down the bike. If you want to be slower, you can downshift to low gear. When descending long, steep slopes, the brakes are used intermittently to decelerate with the help of engine braking.

I Wet and Rainy Environment

In wet conditions, the road surface will be slippery, and wet brakes reduce braking efficiency, so be extra careful when braking in wet conditions.

If the brakes get wet, you can use the brakes at low speeds to help dry the brakes quickly.

Parking

- Stop on firm, flat ground.
- If you must stop on slightly tilted or loose ground, be sure to stop and keep the bike from moving or tipping.
- Ensure that high-temperature components do not come into contact with flammable materials.
- Do not touch the engine, muffler, brake or other high-temperature parts before cooling.
- To avoid the possibility of theft, always lock the handlebars and remove the keys before leaving the motorcycle.

I Stop the car with the side stand

1. Turn off the engine.
2. Lower the side stand.
3. Slowly tilt the motorcycle until its weight is concentrated on the side stand.
4. Turn the handlebars completely to the left.
 - ▶ Turning the handlebars to the right will reduce stability and may cause the bike to fall.
5. Turn ignition to lock position  and remove car keys.

Refueling/Brake Oil and Fuel Guide

Follow these guidelines to protect your engine and catalytic converter:

- Use only unleaded gasoline.
- Use gasoline with recommended octane numbers. Using low-octane gasoline can degrade engine performance.
- Do not use fuels that contain high alcohol concentrations.
- Do not use spoiled or contaminated gasoline, or oil - gasoline mixtures.
- Keep dirt and water out of the tank.
- When adding brake fluid, be sure to avoid splashing into your eyes or sticking to your skin. Brake fluid has a certain dissolving effect, so be sure to avoid contact with non-metallic materials of the vehicle.

Spare Parts and Modifications

We strongly recommend that you do not add any spare parts other than those designed specifically for your motorcycle or modify the original design of the motorcycle. Doing so will make the motorcycle unsafe. Modifications to your motorcycle may also void your warranty and render your motorcycle unlawful for use on public roads and highways. Before you decide to add accessories to your motorcycle, determine which modifications are safe and legal.



Improper fittings or modifications may cause a crash in which you may be seriously injured or even life-threatening. Please abide by the "instruction manual" in all instructions about spare parts and modification.

It is forbidden to attach trailers or straddle buckets to motorcycles; Do not modify or install bumpers at engine mounting points. Your motorcycle is not designed with these accessories, and their use will seriously damage the maneuverability and safety of the motorcycle.

Loading Guide

- Carrying extra loads can affect the maneuverability, braking and stability of a motorcycle. Carrying heavy things, must keep a safe speed when driving to ride.
- Avoid overloading and stay within specified loading limits. Maximum payload 150kg.
- Tie all luggage tightly and place it evenly and smoothly near the center of the motorcycle.
- Do not place any things in headlights or mufflers.



WARNING

Overloading or improper loading can result in an accident that can result in serious injury or death.

Follow the loading restrictions and other loading guidelines in this Instructions.

Parts Location Diagram



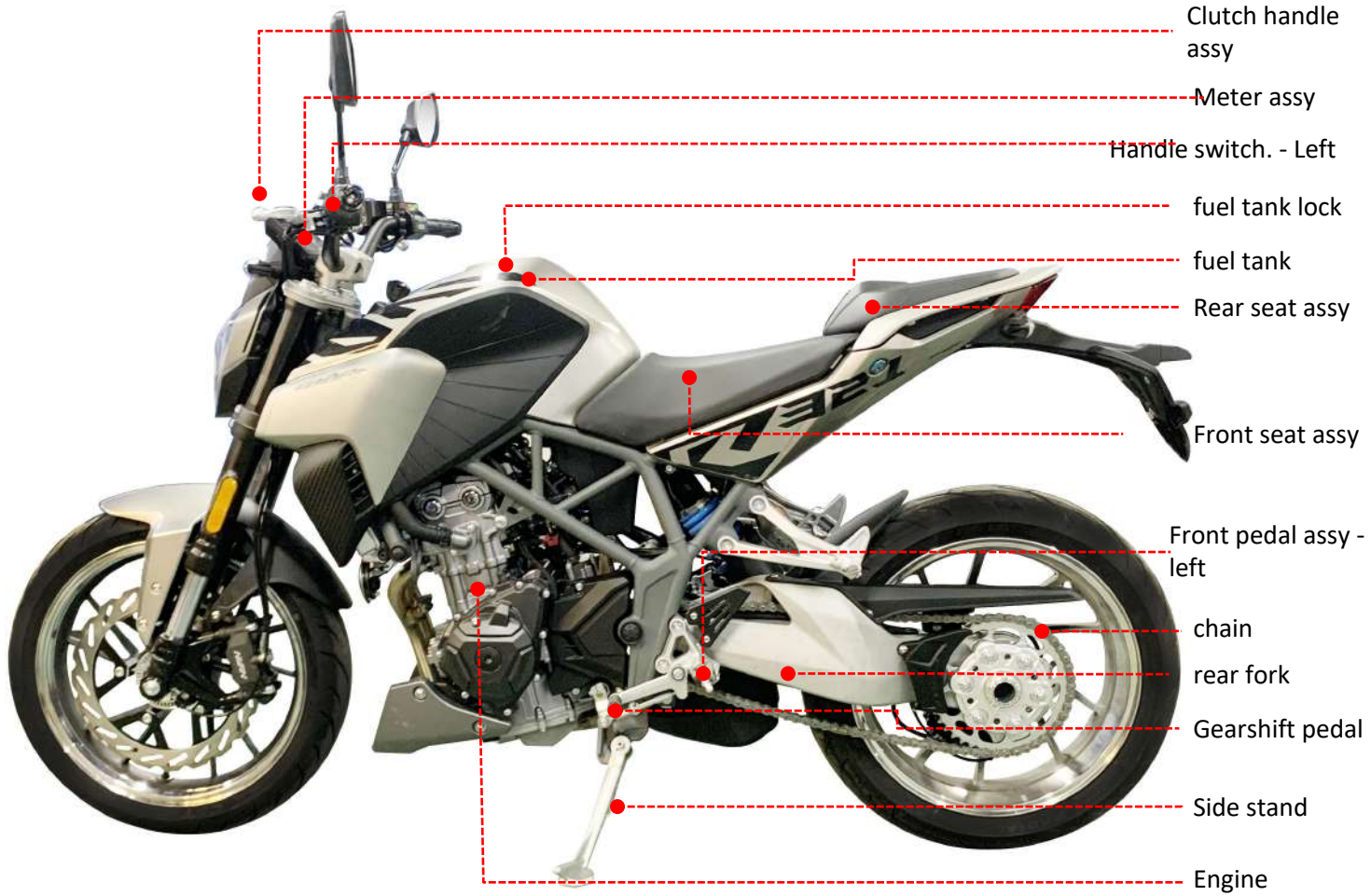

Clutch handle
assy

Meter assy

Handle switch. - Left

fuel tank lock

fuel tank

Rear seat assy

Front seat assy

Front pedal assy -
left

chain

rear fork

Gearshift pedal

Side stand

Engine

Meter



Displays Check

When the ignition switch  is turned to (on), all modes and value bars are displayed. If any part of the display area should be displayed but not displayed, please submit it to the special repair shop for repair.

NO.	Name	Note
①	Turn indicator	When the steering switch is set to the left, the left indicator light flashes When the steering switch is set to the right, the right indicator light flashes
②	Far-light indicator light	This light will be on when the far-light indicator light is on
③	time display	Display current time
④	Tachometer	Engine speed indication
⑤	Speedometer	Km/h
⑥	Maintenance Service Alert	Long press SEL to turn off the light
⑦	Temperature indicator	Displays the current ambient temperature
⑧	Neutral light	When in neutral, this light turn on
⑨	Fuel indicator	Show how much fuel
⑩	EFI fault indicator	This light is on when the efl system fails
⑪	Oil indicator	This light is on when the oil is low
⑫	ABS status display	Display ABS in working state
⑬	ABS malfunction indicator	This light is on when there is a fault
⑭	Gear display	Show gear status
⑮	Odometer	Display the vehicle's accumulated mileage and single mileage
⑯	Position light	When the position light is turned on, this light is on
⑰	Water temperature display	Display of water temperature (1-5th grid is normal ; 6-7th grid shows temperature is too high ; 8th grid shows temperature is too high, you should stop immediately and wait for water temperature to cool)

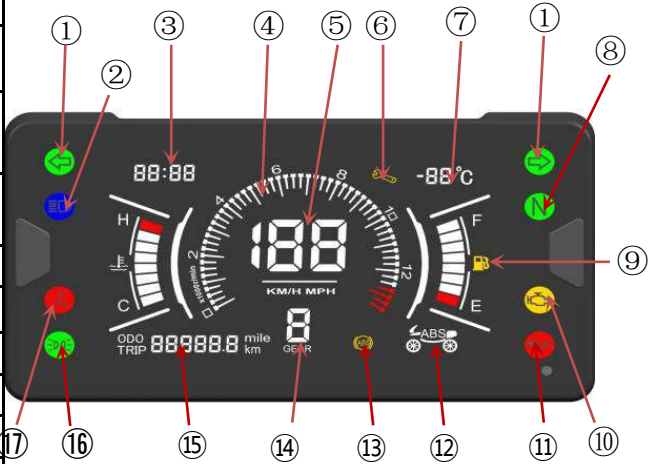

The operation of meter is as follows:

1. Short press the button SET, the ODO/TRIP display is switched;
2. In ODO display mode, long press the button SET, the metric/imperial display is switched;
3. In TRIP display mode, long press the button SET, the subtotal mileage will be reset to zero;
4. When the IGN is powered off, press and hold the SEL button until the door lock is turned on. After the self-check of the meter is completed, it will enter the clock setting mode in about 3 seconds. Short press the SET button to set the hour position (0-23). After the hour setting is completed Long press the SET button, the minute flashes, and short press the SET button to set the minute. After the setting is completed, long press the SET key or no key operation within 5 seconds, the meter will automatically save and exit the clock setting mode.

5. Long press the SEL to enter setting mode,  the ABS character flashes:

① Short press the SEL to select and set the ABS working state;

② If the setting is not successful, the whole icon  will flash, please check the ABS or wiring.

Note: by default, ABS functions of front and rear wheels are fully open, and  icon are often displayed.

6. When the maintenance light is on, it will automatically turn off after driving for 500Km, or long press SEL to turn off the maintenance light.

NOTE:

You must operate the ABS mode in the parking state.

Switch

Right handle switch

Emergency shutdown switch, electric start button



MODE switch button

Engine mode switching

Normally it should be in the  (running) position.



► In an emergency, switch to the  (stop) position to turn off the engine.

electric start button

When the emergency shutdown switch is in the  position:

- ① The engine is in neutral, press this button to start the engine.
- ② If the engine is not in neutral, squeeze the clutch handle and press this button to start the engine.

Light switch

-  turn off the light
-  Front position light, rear position light, license plate light on
-  Headlights, front position lights, rear position lights, license plate lights on

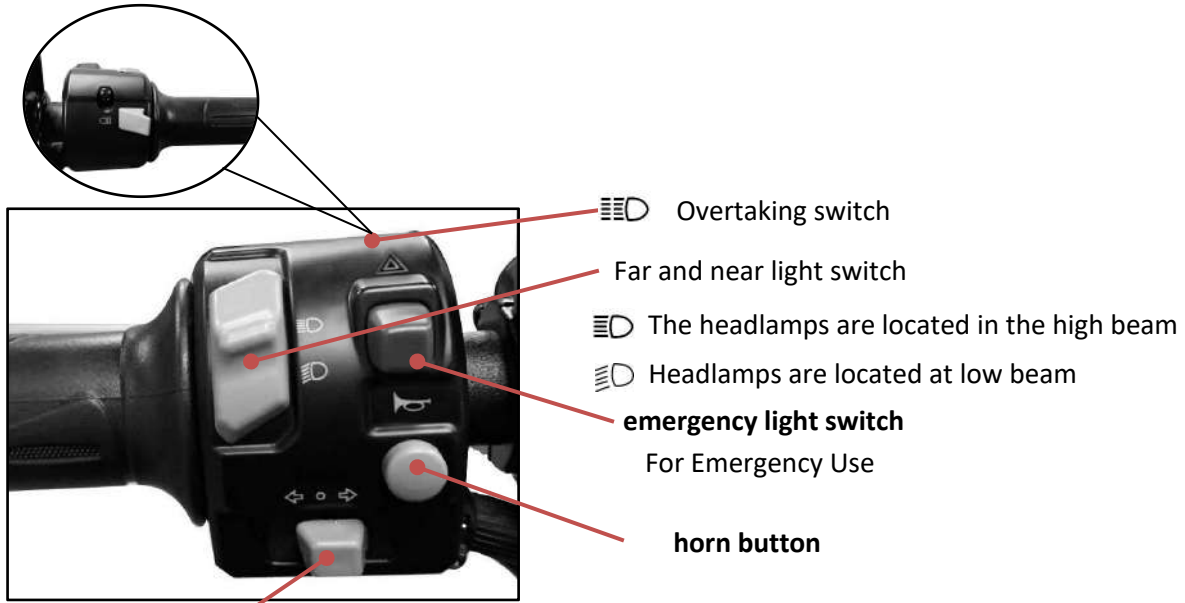

Left handle switch



Turn signal switch

- ← Left turn signal turned on - turn indicator turned left.
After operation, turn signal switch returns to original position
- The right turn signal is on - the turn indicator is switched to the right.
After operation, turn signal switch returns to original position
- Turn signal off - When the turn signal switch is in the middle position,
Press this button to turn off the signal.

Ignition Switch

location	function	note
	Parking use (all circuits are disconnected)	The key can be taken out
	Used when starting or driving	The key can't be taken out





steering lock



warning

When parking (including long parking), the ignition switch must be placed in the "  " or "PUSH" position to keep the vehicle safe and prevent the battery from "running out of power". In the state where the steering mechanism is locked, it is absolutely impossible to push the motorcycle, otherwise it will lose its balance.



Turn the steering handle to the far left, then turn the key to the "  " position, press it in and turn it counterclockwise,

Turn the steering handle to the far left, then turn the key to the "  " position, press it in and turn it counterclockwise until it is at " ", and take out the key. To unlock, simply turn the key clockwise.

start the engine

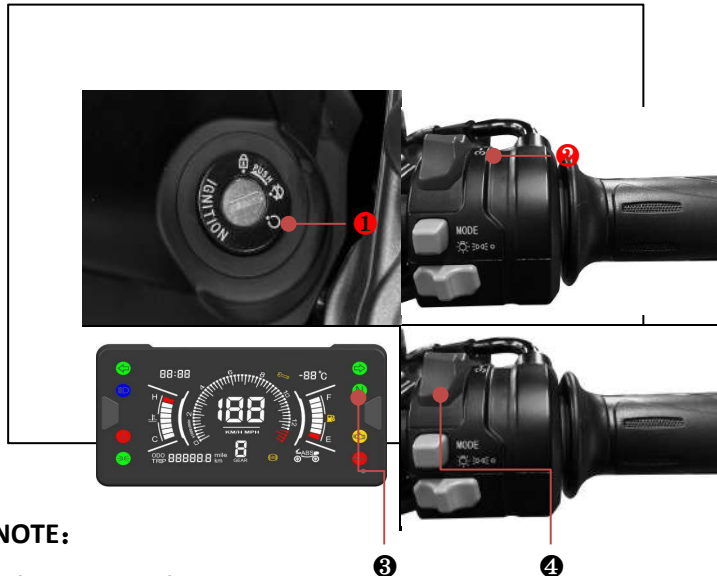
Whether the engine is hot or cold, follow the instructions below to start the engine



- 1 Turn the ignition switch to the  (on) position.
- 2 Make sure the engine flameout switch is in  (running) position.
- 3 The gear is switched to neutral (N neutral indicator lighted).
- 4 With full throttle off, press the start button.

If the engine does not start:

- 1 Full throttle and press the start button for 3 seconds.
- 2 Repeat the normal startup procedure.
- 3 If the engine starts and the idle speed is unstable, gently throttle the valve.
- 4 If the engine does not start, wait 10 seconds and repeat steps 1 and 2.

NOTE:

- If the engine fails to start within 3 seconds, turn the ignition switch to the (off) position. Wait 10 seconds for the battery voltage to recover and start the engine again.
- Prolonged high-speed idling and spinning can damage the engine and exhaust system.
- Sharpening the accelerator or idling at high speed for more than 5 minutes may cause discoloration of the exhaust pipe.
- If the accelerator is fully open, the engine will not start.

Gear Shifting

Your motorcycle has 6 forward gears with a 1-down 5-up shift pattern.

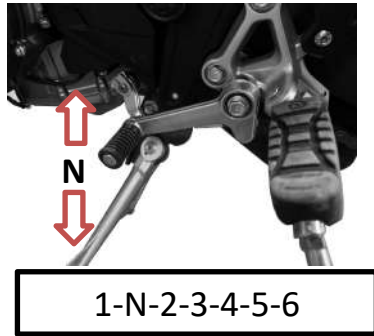

Points to note when driving

- 1、 Avoid unnecessary engine idling, and do not allow the engine to idling at high speed, otherwise it will seriously damage the parts.
- 2、 The clutch disc will wear out quickly when the clutch runs in a semi-detached state.
- 3、 If you feel that the engine horsepower is insufficient when climbing, you should switch to the low speed gear in time.
- 4、 During driving, especially downhill and at high speeds, it is not allowed to use front brakes or neutral taxiing alone.
- 5、 When parking, the accelerator should be small, while disconnecting the clutch, and then braking.

method of shifting

Preheat the engine to make it work properly.

- ① When the engine is idle and disengaged from the clutch, stamp the gearshift pedal to put the transmission into the low gear (first gear) position.
- ② Gradually increase the engine speed and slowly release the clutch handle, the two actions are coordinated to ensure a natural start.
- ③ When the motorcycle reaches a balanced driving state, reduce the engine speed and then disengage the clutch, hook the transmission pedal upwards to enter the second gear, and so on, , and the rest of the shift can be changed in the same way.

Refuel

Injection orifice neck plate

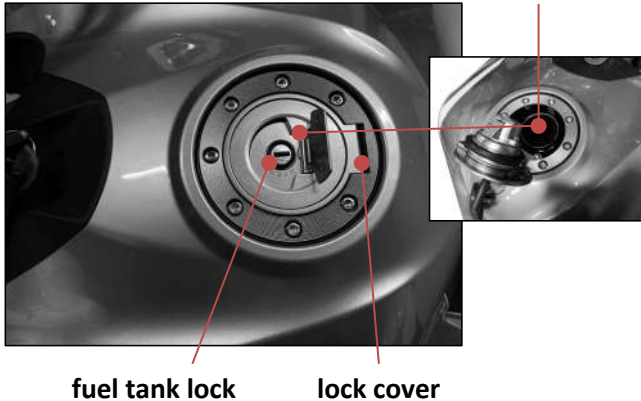

Refueling should not be higher than the neck plate of the injection port.

The fuel tank capacity is 13L. After the side bracket is used to stop the fuel, the

Open the fuel tank lock cap to refill. After filling the fuel, close the lock cover and lock it.

It is recommended to use 92# and above unleaded gasoline.

Open the tank cap

Turn the lock cap, insert the ignition key, turn it in the direction indicated by the arrow, and open the tank cap.

Close the tank cap

- ① After refueling, close the tank cover until locked.
- ② Remove the key and close the lock cover.
 - ▶ If the fuel cap is not locked, the key cannot be removed

warning

Gasoline is a very flammable and explosive substance. when handling gasoline You could be burned or seriously injured.

- Turn off the engine and keep away from heat, sparks or flames.
- Only handle gasoline outdoors.
- If spilled, wipe up immediately.

Maintaining

Please read "The Importance of Maintenance" and "Maintenance Specifications" carefully before preparing for maintenance.

Please refer to "Technical Parameters" for maintenance data.

Importance of maintenance	28	Side stand	47
Maintenance Interval	29	Drive chain	48
Maintenance specification	30	Clutch	50
Tool	39	Throttle	51
Disassembly and installation		Headlamp beam adjustment	52
of body components	40		
Battery	40		
Seat	41		
Enging oil	42		
Cooling liquid	44		
Brake	45		

Importance of maintenance

Importance of maintenance

It's important to keep your motorcycle in good maintenance condition, which is essential for your safety, as well as protecting your property, getting optimal performance, preventing breakdowns, and mitigating air pollution. It is the responsibility of the motorcycle owner to carry out maintenance. Make sure to check before each ride and follow the instructions in the maintenance schedule.



WARNING

Failure to properly maintain or correct malfunctions before riding can result in serious or fatal accidents.

Always follow the inspection, maintenance recommendations and maintenance interval in this User's Manual.

Maintenance Safety

Read the service instructions before each service to ensure you have the necessary tools, parts and skills. We are unable to alert you to every hazard that may occur during maintenance. Only you can decide whether you should perform maintenance repairs.

Please follow the following guidelines for maintenance.

- Turn off the engine and remove the key.
- Park the motorcycle on solid and flat ground with side stand, or support them with maintenance stand.
- Please wait for the engine, muffler, brake, and other high-temperature components to cool down before operating. Otherwise, burns may occur.
- Start the engine only under specified conditions and in a well-ventilated environment.

Maintenance Interval Chart

The vehicle should be maintained according to the stipulated time. The meanings of the symbols are as follows: I: inspection, cleaning and adjustment C: cleaning R: replacement A: adjustment L: lubrication

To ensure safety, it can only be repaired by the company's special store.

Maintenance times		Period	Odometer km (note2)			
			1000km	4000km	8000km	12000km
*	Fuel system oil line					
*	Fuel Filter					
*	Throttle operating system		I			
	Air filter elements	(note 1)				
*	Spark plug		I			
	Exhaust valve clearance		I			
	Inlet valve clearance		I			
*	Engine oil		500 km, 1500 km, it will be replaced at 5000km per month			
*	Engine oil filter		When changing the oil, change it together			
*	Timing chain tension		A	A	A	A
	EFI			I	I	I
	drive chain			I、L	I、L	I、L
	Battery	every month	I	I		I
	Brake pad wear			I	I	I
**	Braking system		I	I	I	I
*	Headlight dimming		I	I	I	I
*	Clutch		I	I	I	I
**	Fastener			I	I	I
**	Steering bearing		I	I	I	I

The vehicle shall be repaired and maintained according to the prescribed maintenance time.

I: inspection, cleaning and adjustment
C: cleaning
R: replacement
A: adjustment
L: lubrication

* This item is repaired by the personnel of the maintenance station. If the user has special tools, accessories and ability, he can also repair by himself. The maintenance knowledge can refer to this maintenance manual.

** To ensure safety, it can only be repaired by the company's special store.

NOTE:1. When driving in dusty areas, it should be cleaned more often.

2. When the number of the milestone exceeds the maximum limit, the maintenance cycle is still repeated according to the mileage interval

service station:
(official seal)

service staff:
User signature :
date:

Maintenance Specification

Importance of maintenance

To ensure safety, it is your responsibility to conduct a pre-ride inspection and to ensure that any problems you find are corrected. Pre-ride inspection is required .

Inspection Item	Details of the inspection
handle bar	Flexible rotation, no clearance and loose
braking system	check running state; front and rear brakes: check brake fluid level and pad wear
Fuel level	Enough to drive the planned distance (please refuel if necessary)
Throttle	Check whether it can be smoothly opened and completely closed at each steering position
Clutch	Check its operational state; if necessary, adjust the free stroke
Wheels and Tires	Check its usage and tire pressure, and refill if necessary
drive chain	Check its condition and sag, adjust and lubricate it if necessary
Lighting, horns	Check lighting system and horn for good performance
oil level	Add engine oil if necessary; check for leaks
Instrument indication	Check whether the indicator light on the instrument is displayed normally

Parts Replacement

To ensure reliability and safety, please use OEM parts.

Battery

You do not need to check the battery electrolyte water level and add distilled water. Clean the battery terminals if they are dirty or corroded.

NOTE

Improper battery handling may cause harm to the environment and human health. Be sure to check local regulations for proper battery handling.

■ Cleaning battery Terminals

1. Remove the battery.
2. If the terminals are just beginning to corrode and are covered with white material, wash them with warm water and wipe them clean.
3. If the terminals are severely corroded, use a wire brush or sandpaper to clean and polish. Wear safety glasses when polishing.

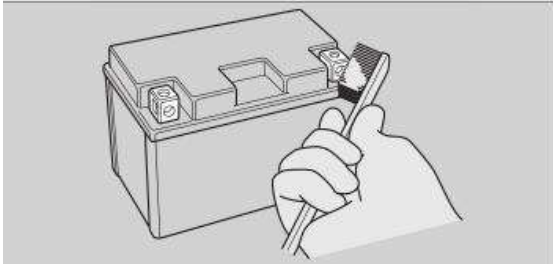

4. After cleaning, put the battery back in.

Battery life is limited. Ask the repair shop when the battery needs to be replaced. Be sure to replace the battery with the same type.

NOTE

Installing non-original electrical accessories can overload the electrical system, discharge the battery, and possibly damage the system.

Fuse

The fuse protects the circuit on your motorcycle. If some electrical parts on your motorcycle stop working, check and replace the blown fuse.

■ Check and replace fuses

Turn the ignition switch to the  (off) position to remove and check the fuse. If the fuse is blown, replace it with a fuse of the same size. Please refer to "Technical Parameters" for fuse specifications

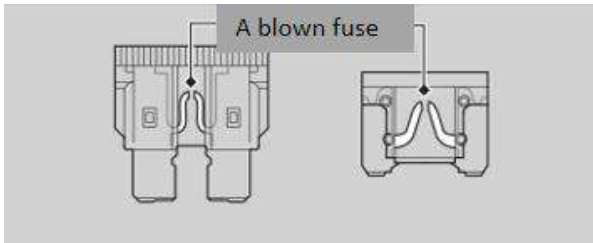

NOTE

Replacing a fuse with a higher rating will increase the chance of damaging the electrical system.

If the fuse blows frequently, there may be an electrical problem. Please take it to a repair shop for overhauling the motorcycle.

Engine Oil

Engine oil consumption and oil quality degradation will vary depending on riding conditions and usage time. Check the engine oil level frequently and add the recommended engine oil if needed. Dirty or old oil should be replaced as soon as possible.

■ Selecting engine oil

The engine oil should be SN grade above API classification, and its brand number should be above 10W-40 SG

Brake fluid

Do not add or replace brake fluid except in an emergency. Use only newly removed brake fluid from the sealed container. If you have added brake fluid, ask the repair shop to check the brake system as soon as possible.

NOTE

Brake fluid can damage plastic and paint surfaces.
If spilled, erase immediately and wash thoroughly.

Recommended brake fluid:

DOT 4 brake fluid or equivalent

drive chain

The drive chain must be checked and lubricated regularly. Check the chain more frequently if you are frequently driving under poor road conditions, at high speeds or repeatedly speeding up.

If the drive chain is not running smoothly, makes an abnormal noise, has a damaged roller or loose latch, is missing or bent o-rings, please refer the chain to the repair shop for inspection.

Check both the active sprocket and the driven sprocket at the same time. If any of them have worn or broken teeth, please replace them with a repair shop.

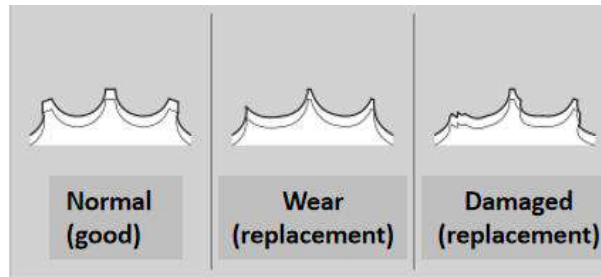

NOTE

Using a new drive chain on a worn sprocket will speed up chain wear. Drive chain and sprocket should be replaced at the same time.

■ Cleaning and Lubrication

After checking the sag, clean the chain and sprocket while turning the rear wheel. Use a dry cloth and o-ring chain special cleaner or mild stain remover. If the chain is dirty, a soft brush can be used. After cleaning, wipe dry and lubricate with recommended lubricant.

Recommended lubricating oil:

O-ring chain special oil

If not available, use SAE 80 or 90 gear oil

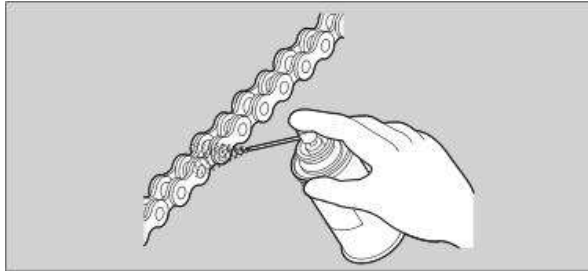

Do not use non-O-chain steam cleaners, high-pressure cleaners, wire brushes, volatile solvents such as gasoline and benzene, scrubbers, chain cleaners and lubricants, or O-rings may be damaged.

Avoid getting lubricating oil on brakes or tires. Avoid using excess lubricants to avoid splashing onto clothing or motorcycles.

Recommended coolant

Only original, unhydrated locomotive premix coolant can be used. The original locomotive premix coolant provides excellent protection against corrosion and overheating. Coolant should be properly checked and replaced according to the maintenance schedule.

NOTE

The use of non-aluminum engine coolants, plain tap water, or mineral water can cause corrosion.

Tyre (Inspection/replacement)

■ Check the tire pressure

At least once a month or at any time when you feel that the tire pressure is insufficient, visually measure the tire and measure the tire pressure with a barometer. Check the tire pressure as the tires cool.

■ Damage check

Inspect the tire for cuts, cracks, exposed fabric or tire cord or for nails or other foreign objects embedded in the side or tire pattern of the tire. Also check the tire sidewalls for any abnormal bulges or swelling.

■ Abnormal wear inspection

Check tire contact surfaces for signs of abnormal wear.

■ Check the tread depth

Check tread wear indication mark. If the wear reaches the indicated mark, replace the tire immediately.

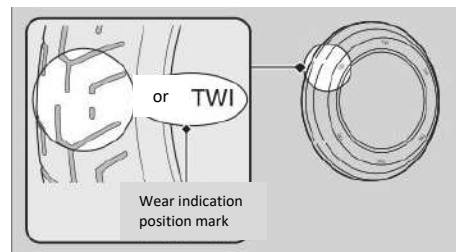

warning

Using tires that are worn out or improperly inflated can lead to accidents and serious injuries. Please follow the relevant tire inflation and maintenance instructions in the Operation Manual.

Whenever you change a tire, follow these guidelines:

- Use the recommended tyre or an equivalent product of the same size, construction, speed class and load.
- After the tire is installed, use the original balance positioner or equivalent equipment to balance the wheel.
- Do not install inner tubes in the tubeless tyres of this motorcycle. Too much heat can cause the inner tube to burst.
- Only tubeless tires can be used on this motorcycle. Rims are designed to use tubeless tires. During sharp acceleration or braking, tires with inner tubes slide over the rim, causing rapid air leaks.

Fitting unsuitable tires can affect handling and stability, and lead to accidents that can seriously injure you or endanger your life. Always use tires of the size and type recommended in this Manual.

Air Filter

The motorcycle is fitted with a paper air filter element.

Do not maintain by yourself.

It should be cleaned or replaced by a repair shop.



air filter element

TOOL

Onboard tools are stored under the seat

You can use the onboard tools for some simple repairs, minor adjustments, and parts replacement.

- Double-headed screwdriver
- Double end wrench 8X10
- Double end wrench 12X14
- Inner hexagon wrench NO.5
- Inner hexagon wrench NO.6
- Fishtail tongs
- Tool bag

Remove and install body components

Battery

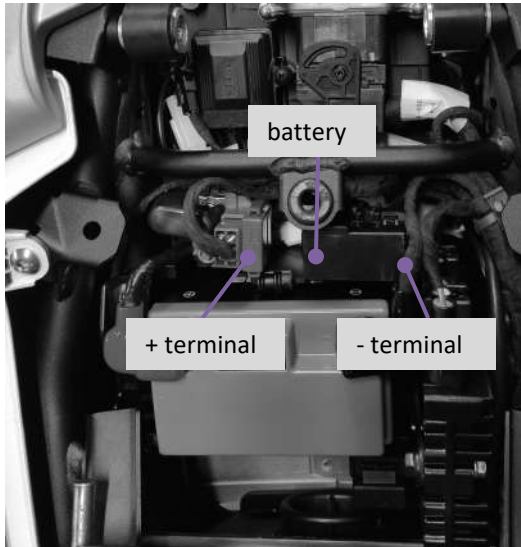

■ disassembly

Make sure the ignition switch is turned to the  (off) position.

1. Remove seat.
2. Loosen the rubber band from the rear.
3. Disconnect the battery negative terminal.
4. Disconnect the battery positive terminal
5. Remove the battery and be careful not to leave the

bolts and nuts behind.

■ Installation

Install components in reverse order of disassembly. Be sure to connect the positive terminal first and the negative terminal last. Make sure the bolts and nuts are tightened.

seat

Disassembly

1. Insert the ignition key into the seat cushion lock.
2. Turn the key clockwise, while pulling up the rear end of the seat cushion to disengage the lock, and then take off the rear seat cushion assembly diagonally upwards.

Installation

1. Clamp the front end and rear end pins of the rear cushion assembly into the frame slot respectively.
2. Align the seat lock pin with the keyhole, press down on the rear of the seat cushion, and insert the lock pin into the seat seat lock hole and automatically lock the lock tongue. Gently pull up to make sure the seat cushion is firmly locked in place.

When the seat cushion is closed, the seat cushion lock automatically locks.

NOTE

Make sure the seat cushion latch is accurately inserted into the frame card slot, otherwise the seat cushion will not be able to withstand your weight and the seat cushion may be crushed.

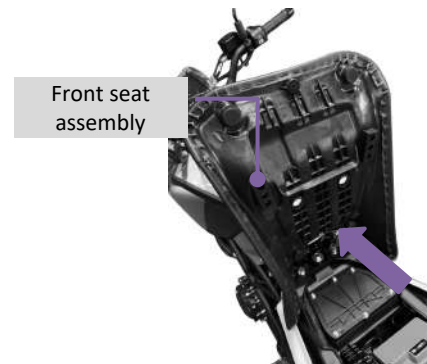
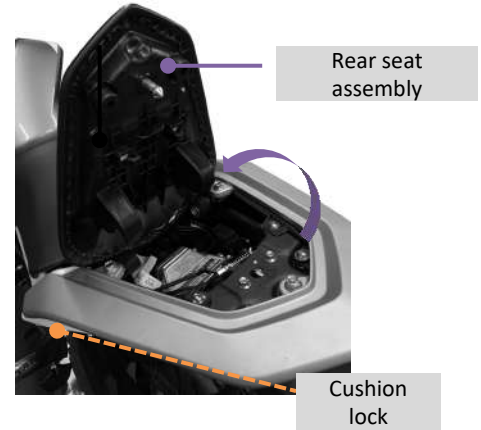

Engine Oli

Check engine oil

1. Idle for 3 to 5 minutes.
2. Turn the ignition switch to  (off) position and wait 2 to 3 minutes.
3. Position the motorcycle vertically up on firm, flat ground.
4. Check whether the oil level is between the upper and lower oil level marks from the engine oil level inspection port.

Add engine oil

If the engine oil is lower than or close to lower oil level mark, add the recommended engine oil, please.

1. Remove the engine oil injection cap.

Add the recommended oil to the upper oil level mark.

- ▶ Check the oil level, the motorcycle vertical placed on solid smooth ground.
- ▶ Refueling should not exceed the upper oil level mark.
- ▶ Ensure that no other objects enter the engine oil injection port.
- ▶ If spilled, wipe off immediately.

2. Reinstall the engine oil injection cap and tighten it.

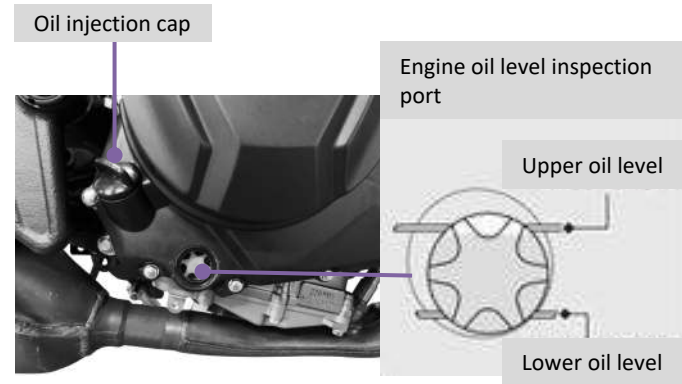

NOTE

Too much or too little oil can damage the engine. Do not mix different brands and grades of oil. This affects lubrication and clutch operation

For recommended oil types and selection guidelines, see "Maintenance Specifications".

Change the engine oil and filter

Changing engine oil and filters requires special tools. We recommend it by a repair shop.

Use the original engine oil and filter specified for your model, or equivalent products.



NOTE

Using the wrong engine oil filter can seriously damage the engine.

1. If the engine is cold, idle for 3 to 5 minutes.
 2. Turn the ignition switch to the (off) position and wait 2 to 3 minutes. 
 3. Park the motorcycle on a firm level.
 4. Place an oil drain pan under the drain bolt.
 5. Remove the engine oil filler cap, drain bolt and gasket. Then drain the oil.
 6. Use a filter wrench to remove the engine oil filter and drain the remaining oil. Make sure the old rubber ring is not sticking to the engine.
- Discard oil and filters at the recycling center.

7. Apply a thin coat of engine oil to the rubber seal of the new filter.

8. Install a new engine oil filter and tighten it.

Torque: 17 N·m (2.7 kgf·m, 19 lbf·ft)

9. Install a new sealing gasket to the drain bolt.

Tighten the drain bolts.

Torque: 20 N·m (3.1 kgf·m, 22 lbf·ft)

10. Add the recommended oil to the crankcase and install the oil injection port cover.

After disassembling the crankcase, the required amount of oil:
2.4L

When replacing the filter element, the required amount of oil:
2.1 L

When the filter element is not replaced, the amount of oil required: 1.8 L11. Recheck level

12. Check for oil leaks.

check cooling liquid

When the engine is cool, check the coolant level in the water reservoir.

1. Park the motorcycle on a firm level.
2. Keep the motorcycle upright.
3. Check whether the coolant level in the water reservoir is between the upper and lower limit level marks.

If the coolant level drops significantly or the reservoir is empty, there may be a serious leak. Please have the motorcycle repaired by a repair shop.

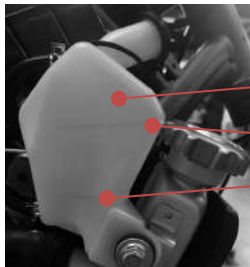

water reservoir

upper limit

lower limit

Add cooling liquid

If the coolant level is below the lower limit mark, add the recommended coolant until the level reaches the upper limit mark. Only add coolant from the lid of the tank and do not remove the lid of the radiator.

1. Remove the radiator cap, add coolant and note the coolant level.
 - ▶ Don't over the upper limit.
 - ▶ Ensure that no foreign matter enters the radiator cover.
2. Reinstall the radiator cover.



warning

Removing the radiator cap while the engine is hot can cause coolant to spray out, possibly causing you to burn. Always wait for the engine and radiator to cool before removing the radiator cap.

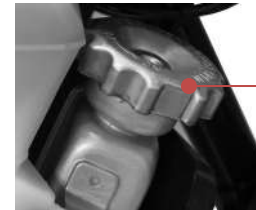

radiator cap

Change cooling liquid

Unless you have the right tools and qualified mechanical skills, please have the coolant replaced by a repair shop.

Check the brake fluid

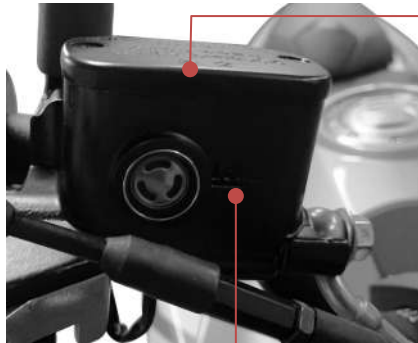

Front brake fluid storage tank

LOWER

1. Position the motorcycle vertically up on firm, flat ground.
2. Check whether the brake fluid storage tank is level and the brake fluid level is higher than the lower limit (**LOWER**) 。
3. Check whether the brake fluid storage tank is level and the brake fluid level is above the lower limit.

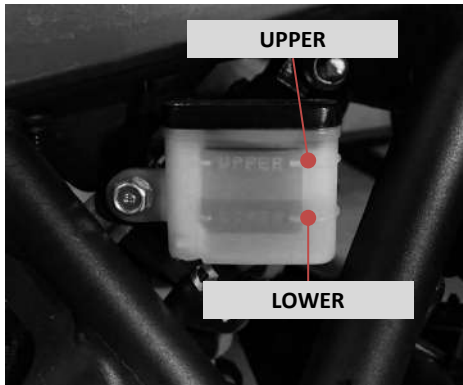

UPPER

LOWER

If the brake fluid level in any of the tanks is below the LOWER level mark, or if the brake lever and pedal's free travel exceeds the limit, the brake discs must be checked. If the brake pads are not worn, there may be a leak. Please send the motorcycle to the repair shop for repair.

Check the brake pads

Check the status of brake disc wear indicator. If the brake disc is worn to the indicating mark, it needs to be replaced.

1. **FRONT** Check the brake pads from under the brake calipers.

Lining thickness of brake disc:

FRONT Lining thickness of brake disc: 4mm
(Indication marked as wear limit)

2. **REAR** Check the brake pads from the rear right of the brake caliper.

Lining thickness of brake disc:

REAR Lining thickness of brake disc:
4mm (Indication marked as wear limit)

If necessary, have the brake pads replaced by a repair shop. The left and right brake pads must be replaced at the same time

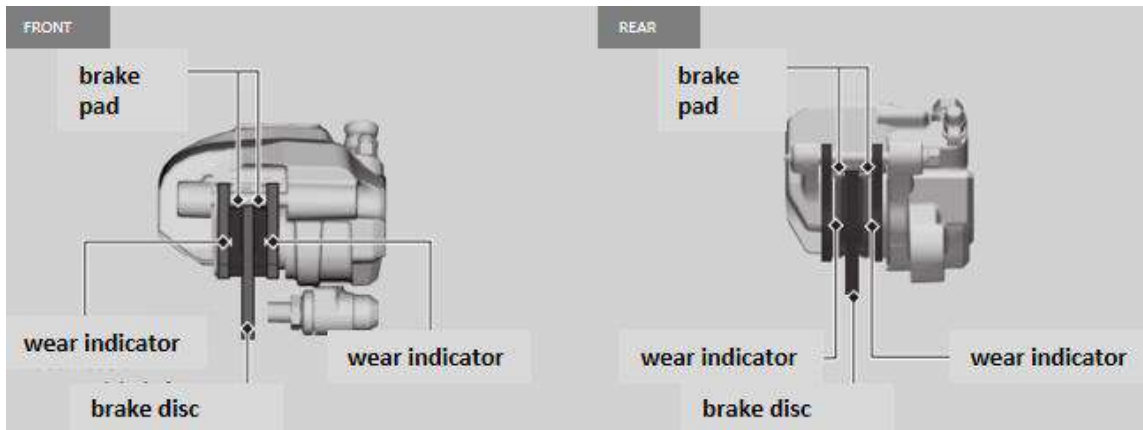

Side Stand

Inspection side stand

1. Check that the side brackets operate freely. If the side brackets operate stiffly or "squeak", clean the pivot area and lubricate the pivot bolts with clean grease.
2. Check the spring for damage or loss of elasticity.



Check drive chain sag

Check the sag of different points along the chain. If not all points have the same sag, some links may already be bent and twisted.

Please leave the chain to the repair shop for inspection.

1. Put the transmission in neutral. Turn off the engine.
2. Position the motorcycle vertically on firm, flat ground.
3. In the area behind the chain guard, push the chain away from the fork to determine the sag of the chain.

Drive chain sag: 35-50mm

- ▶ If the sag exceeds 50 mm, you cannot continue to ride the motorcycle.
4. Turn the rear wheel forward to check that the chain is running smoothly.
 5. Check the sprocket.
 6. Clean and lubricate the drive chain.

NOTE

When checking drive chain sag, make sure the upper part of the chain must be tensioned.

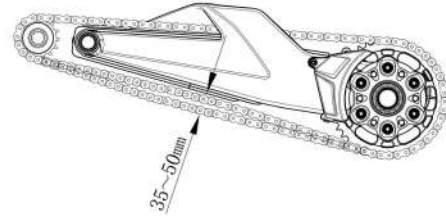

Adjust the sag of the drive chain

When adjusting the drive chain sag

1. Put the transmission in neutral. Turn off the engine.
2. Position the motorcycle vertically on firm, flat ground.
3. Remove chain box and rear fender bracket.
4. Loosen the two locking bolts for the rear flat fork.
5. Insert 2 Phillips screwdrivers into the regulation holes respectively, turn the tire to adjust the angle of the rear sprocket, and check the chain sag.
6. In the area behind the chain guard, push the chain toward the fork to determine the proper sag of the chain.

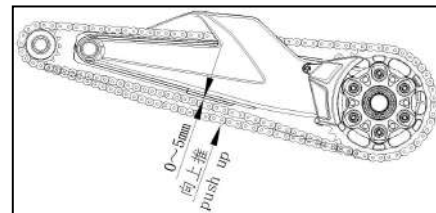
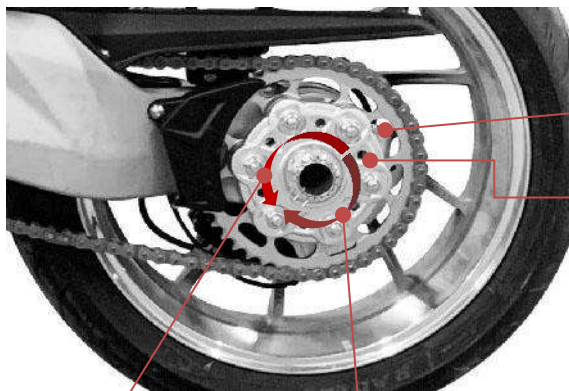

Diagram of tightness

the sag of the drive chain: 0-5mm



The chain tightening

The chain loosening

Rear fork locking bolt



regulation hole

NOTE
When adjusting the drive chain sag, ensure that the upper part of the chain must be tensioned.

Clutch

■ Check the free stroke of the clutch handle

free stroke of the clutch handle : 10 - 15 mm

Check whether the clutch cable is bent or damaged. If necessary, please send it to the repair shop for replacement.
Lubricate the clutch cable with special cable oil to prevent wear and corrosion.

NOTE

Improper free stroke adjustment can cause clutch wear.

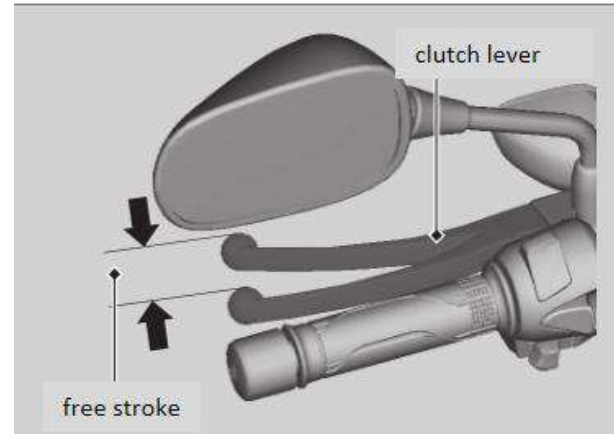

Throttle

check the throttle

With the engine off, check that the throttle smoothly switches from full off to full on in all directions and that the free stroke is correct. If the throttle operation is not smooth, automatic closing or cable breakage, please refer to a repair shop for repair.

Free stroke of throttle lever flange : 2-6 mm

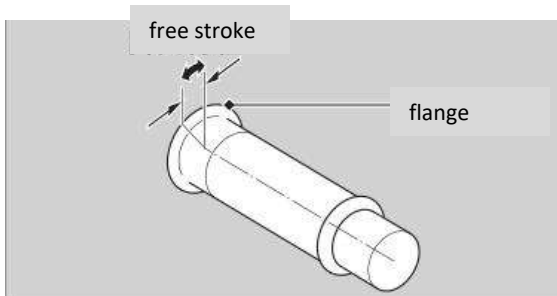

Adjusting brake handle

You can adjust the distance between the top of the brake handle and the handle glue.

■ adjustment method

Push the brake handle in to the desired position while turning the adjuster until the numbers line up with the markings.

After adjustment, check whether the brake handle works properly before riding.

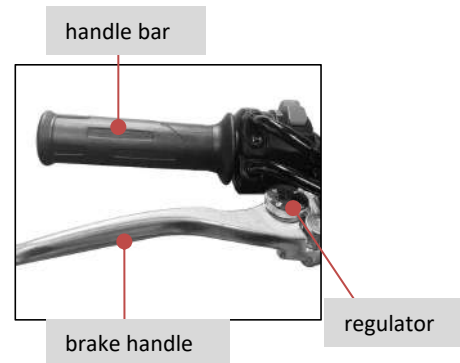

NOTE

Do not spin the regulator beyond its limit.

Headlight

Adjust the headlight beam

You can adjust the longitudinal Angle of the beam by moving the headlights. If necessary, use the Phillips screwdriver provided in the tool box

Comply with local laws and regulations

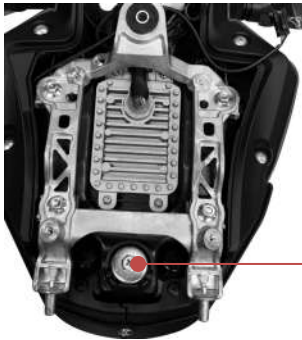

regulating screw

Troubleshooting

Please read the "Maintenance Importance" and "Maintenance Specification" carefully before attempting any maintenance. Maintenance data refer to "technical parameter".

Engine cannot start	
(indicator light on)	54
Overheat (coolant high temperature	
indicator light on).....	55
Warning light is on or	
blinking	56
Low oil pressure indicator light	56
Efi system fault indicator	56
ABS (anti-lock braking system)	
indicator light.....	56
Other Warning instructions	58
Fuel gauge failure indication	58
puncture the tire	59
electrical failure	64
run out of battery	64
blown fuse	64

Engine won't start

The starter motor runs but the engine fails to start

Check the following:

- Check the correct engine start sequence
- Check the tank for gasoline
- Check whether the battery voltage is too low.

The starter motor does not work

Check the following:

- Check whether the battery voltage is too low.
- Confirm that the engine start order is correct
- Confirm that the engine flameout switch is in the (running) position
- Check whether the fuse is blown
- Check whether the battery connection is loose or the battery end is corroded
- Check the battery condition if the problem persists,

Please leave the motorcycle to the repair shop for service.

Overheat (coolant high temperature indicator light on)

The engine overheats in the following cases:

- Coolant high temperature indicator light on
- Slow acceleration

In this case, push the motorcycle safely to the side of the road and take the following measures.

Long periods of high idle speed may cause the coolant high temperature indicator to come on.

NOTE

Continuing to drive while the engine is overheating can seriously damage the engine

1. Turn off the engine with the ignition switch, then turn to the  (on) position.

2. Check that the radiator fan is running, then turn the ignition switch to the  (off) position.

If the fan is not running:

Suspected malfunction. Do not start the engine. Take your motorcycle to the repair shop for repair.

If the fan is running:

Hold the ignition switch in  (off) position and wait for the engine to cool.

3. After the engine has cooled, check the radiator hose for leaks.

If there are leaks:

Do not start the engine. Take your motorcycle to a repair shop for repair.

4. Check coolant level in coolant storage tank.

- ▶ Add coolant if necessary.

5. If checks 1–4 are OK, you can continue driving, but keep an eye on the coolant high temperature indicator light.

Warning light is on or blinking

Oil low pressure indicator light

If the low oil pressure indicator light comes on, push safely to the side of the road and turn off the engine.

NOTE

Continued riding under low oil pressure can seriously damage the engine.

1. Check engine oil level and add oil if necessary.
2. Start the engine
 - ▶ Continue riding only after the low oil pressure indicator light has gone out.

Rapid acceleration may cause the low oil pressure indicator light to come on immediately, especially if the oil is at or near the low limit.

If the oil level is normal and the low oil pressure light is still on, turn off the engine and contact a repair shop.

If the engine oil level drops rapidly, your motorcycle may be leaking oil or have other serious problems. Please have the motorcycle repaired by a repair shop.

Efi system indicator light



If this indicator light is lit during the ride, there may be a serious problem with your EFI system. Please slow down and hand over the motorcycle to the repair shop for repair as soon as possible.

ABS (anti-lock braking system) indicator light

If the indicator light shows any of the following conditions, there is a serious problem with your ABS. Please slow down and have your motorcycle checked by a repair shop as soon as possible.

- The indicator light is on or starts flashing when riding.
- The indicator light does not come on when the ignition switch is in the  (on) position.
- When the speed is higher than 5 km/h, the indicator light does not go out.

If the ABS indicator light is still on, your braking system will work as normal, but without anti-lock braking.

The ABS indicator light may flash when the front wheel of the motorcycle is moving or the rear wheel is slipping. In this case, turn the ignition switch to the  (off) position and then to the  (on) position.

The ABS light will go out when your speed reaches 12 km/h.

puncture the tire

Repairing punctures or removing wheels requires special tools and expertise. We recommend taking this type of repair to a repair shop.

If you have done an emergency tire repair, be sure to go to a repair shop to inspect the motorcycles or replace the tire.

Use a tire repair kit for emergency repairs

If your tire is slightly punctured, you can use a tubeless tire repair kit for emergency repairs.

Follow the instructions provided with the Tire Emergency Repair Kit.

Riding a motorcycle with temporary tire patches is dangerous. Speeds should not exceed 50 km/h.

Replace the tires with the repair shop as soon as possible.



WARNING

It is dangerous to ride a motorcycle with a temporary tire repair. If the temporary repair fails, an accident will occur, resulting in serious injury or death.

If you must ride a motorcycle with a temporary tire repair, ride it slowly and cautiously. Do not exceed 50 km/h until the tire is changed.

Remove the wheel

If you need to remove the wheel to repair a puncture, follow these steps. When you remove and install the wheel, be careful not to damage the wheel speed sensor and ABS ring gear

I front wheel

disassembly

1. Securely support your motorcycle with a service stand or crane and lift the front wheels off the ground.

2. Remove the front fender

3. Remove the left brake caliper.

- ▶ Support the brake caliper assembly and do not hang on the brake hose. Do not twist the brake hose.

- ▶ Avoid getting lubricating oil, oil or dirt on the brake discs or pads.

- ▶ Do not pull the brake handle when the brake caliper is removed.

- ▶ Be careful not to scratch the wheel when removing the calipers.

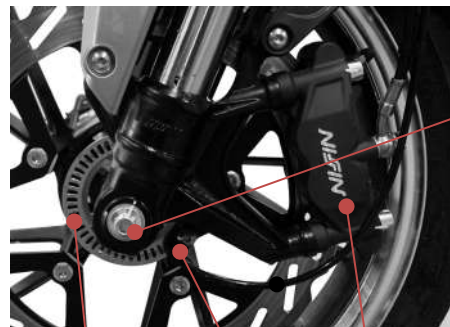

Front wheel bearing

ABS ring gear

speed sensor

Brake callipers

4. Loosen axle lock bolts and front axle.

5. Remove front axle, front wheel.



锁紧螺栓

Installation

1. Put the front wheel in the middle of the front shock absorber; the front wheel bushing - left is placed in the left mounting hole of the front wheel, and the brake disc is inserted into the brake caliper
2. Pass the front axle through the front wheel from right to left, and then install the front axle locking bolt. (Front axle M10, torque: 60N.m, front axle locking bolt M8, torque: 22N.m)
3. Install brake calipers and tighten bolts.
torque: 45 N·m
 - ▶ Be careful not to scratch the wheel with brake calipers during installation.
 - ▶ Install brake calipers using new assembly bolts.
4. Install the front fender (long ends are assembled backwards). Torque: 8 N·m

5. Place the front wheels on the ground.
6. Operate brake handle several times. Then shake the front fork up and down several times.
7. Lift the front wheel off the ground again and check that the wheel rotates smoothly after you release the brake handle.

If the torque wrench is not used during installation, please send it to the repair shop for correct installation. Improper installation will result in braking performance degradation.

NOTE

When installing the wheels or calipers in place, carefully install the discs between the brake pads to prevent them from being scratched.

When installing the front wheel, the front axle bolt must be installed first, followed by the lock bolt on the right side of the front axle, and the order of the two is not interchangeable

I Rear wheel

Disassembly

1. Park the motorcycle on a stable, level surface.
2. Securely support your motorcycle with a side stand or service stand and lift the rear wheel off the ground.
3. Remove the rear section of muffler.
4. Remove the steel clasp on the right side of the rear axle.
5. Remove the lock nut on the right side of rear axle.
6. Remove the gasket, tapered bushing.
7. Remove the rear wheel.

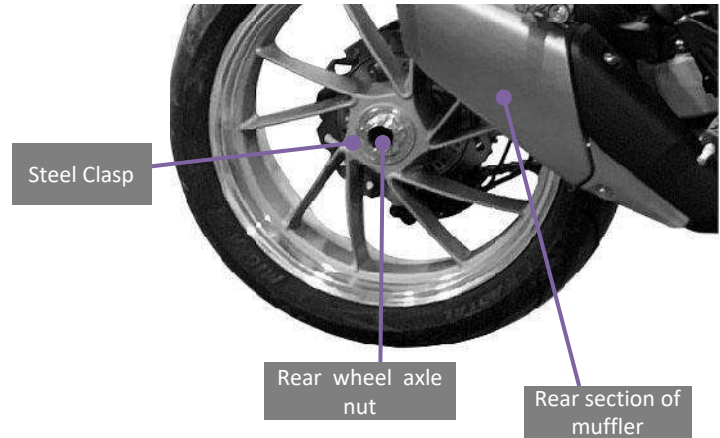

Installation

1. Install the rear wheels in reverse order of removal.

- ▶ Be careful not to scratch the wheel with brake calipers during installation

NOTE

When installing the wheel or caliper in place, carefully install the brake disc between the brake discs to prevent scratches.

2. Evenly spread butter on the needle bearing
 3. Align the rear wheel holes with the positioning pins on the rear wheel axle and insert them into the rear wheel mounting holes.
 4. Insert the tapered bushing and gasket (the tapered bushing and contact gasket side are evenly greased).
 5. Tighten the rear axle nut.
torque: 168N·m
 6. Insert the steel clasp
 7. Install the rear section of the muffler
torsion: 22N·m
- Check the wheel, should turn freely.

If a torque wrench is not used during installation, leave it to the repair shop as soon as possible to confirm proper installation. Improper installation can lead to a decrease in braking performance.

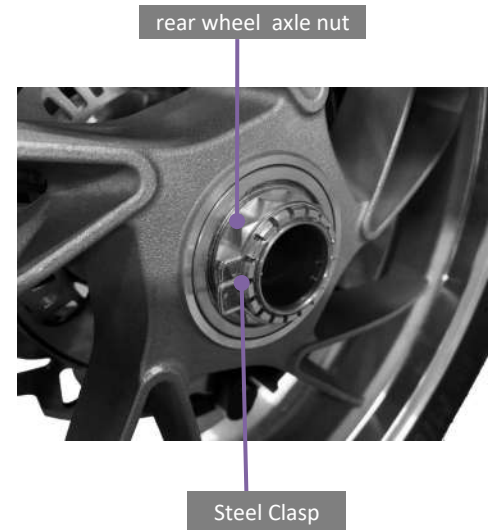

Electrical Failure

run out of battery

Please use the special charger for motorcycle lithium battery to charge the battery. Remove the battery from the motorcycle before charging. Do not use car battery chargers or motorcycle lead-acid battery chargers for charging, which will cause the motorcycle battery to overheat and cause permanent damage.

If the battery still does not recover after charging, please contact a repair shop.

NOTE

It is forbidden to charge with a car battery charger or a motorcycle lead-acid battery charger, as this can damage the electrical system of your motorcycle.

The fuse is blown

Before handling fuses, refer to "Checking and replacing fuses"

I Fuse box

1. Remove the seat
2. Remove the fuse box cover.
3. Pull out the fuse, check if the fuse is blown, and if it blows, be sure to replace it with a spare fuse of the same size.
4. Install the fuse box cover.
5. Install the seat

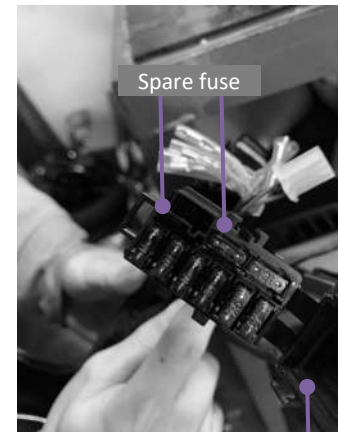

fuse box cover

Related Information

key	66
Motorcycle Instrument	
Controls and Other Functions	67
Maintenance of	
Motorcycle	68
Storage of motorcycles	71
Transportation of	
motorcycles	71
Environment	72
VIN	73
Nameplate	73
Catalytic converters	74

Key

Ignition Key

This motorcycle has two ignition keys, which start the engine

- Do not bend the key or put it under too much pressure.
- Avoid prolonged exposure to the sun or high temperature environment
- Do not grind, drill, or change its shape in any way.

In order to prevent loss, please keep one of your keys in a safe place. If you are worried about losing it, please make a copy immediately.

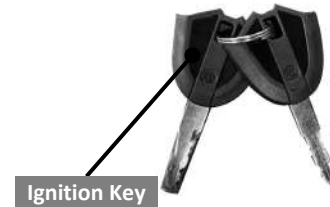

Motorcycle Instrument 、 Controls and Other Functions

Ignition Switch

When the engine is stopped, the ignition switch is in the  (on) position to drain the battery.

Do not turn the key while riding.

Engine Fire-off Switch

Do not use the engine fire-off switch unless in a state of emergency. Doing so while riding can cause the engine to stop abruptly and make the ride unsafe.

If you use the engine fire-off switch to turn off the engine, be sure to turn the ignition switch to the  (off) position, otherwise, the battery will be drained.

Odometer、 Milometer

Odometer: When the reading exceeds
999,999,

The display will be locked at 999,999.

Milometer: When the meter reading exceeds
9999.9, the count is cleared.

Maintenance of Motorcycle

Frequent cleaning and polishing ensures that the motorcycle lasts a long time. Clean motorcycles are more likely to find potential failures.

In particular, anti-icing seawater and salt spilled on the road can accelerate the corrosion. Always wash the motorcycle thoroughly after driving along the coast or on surfaces treated as above.

Cleaning

Wait for the engine, muffler, brake and other high-temperature components to cool before cleaning.

1. Rinse the motorcycle thoroughly with a low pressure hose to remove dirt.
2. If necessary, use a sponge or soft towel dipped in a flexible cleaner to remove dirt.
3. Wash the motorcycle thoroughly with enough clean water and dry it with a clean soft cloth.
4. After drying the motorcycle, lubricate the moving parts.
 - ▶ Make sure no lubricant is spilled on the brakes or tires. Oil-contaminated brake discs, brake pads, brake drums, and brake shoes will greatly reduce the braking performance and may lead to accidents.
5. Lubricate the drive chain immediately after cleaning and drying the motorcycle.
6. Wax prevents corrosion.
 - ▶ Avoid products that contain strong detergents or chemical solvents. These substances can damage metal parts, paint and plastic parts on motorcycles.

Do not wax tires and brakes.

- ▶ If your motorcycle has matte finish parts, do not wax the them.

I Cleaning Precautions

Please follow the following instructions when cleaning:

- No high-pressure water gun:
 - ▶ High-pressure water guns can damage moving and electrical parts, making it impossible to repair them.
 - ▶ Water from the air intake may be drawn into the throttle body and/or into the air filter.
- Do not flush the muffler directly with water:
 - ▶ Intake of water into the muffler may result in failure to start and rust of the muffler.
- Dry the brake:
 - ▶ Water can reduce braking performance. Applying the brakes at low speeds intermittently after washing will help dry.
- Do not rinse the bottom of the seat directly with water:
 - ▶ Water entering the seating can damage your documents and other items.
- Do not flush the air filter directly with water:
 - ▶ If water enters the air filter, the engine may not start.
- Do not wash headlights directly with water:
 - ▶ After washing or when riding in the rain, the internal lens of the headlamp may be temporarily foggy. This does not affect the functionality of the headlamp. However, if you notice a lot of water or ice accumulating inside the lens, please take the motorcycle to a repair shop.
- Do not wax and polish on matte paint:
 - ▶ Clean the matte finish with a soft cloth or sponge, plenty of water and a mild detergent. Dry with a clean soft cloth.

Aluminum components

Aluminum corrodes when it comes into contact with dirt, mud or salt. Clean aluminum parts regularly and follow the following guidelines to prevent scratches:

- Do not use hard brush, steel ball or other friction cleaning products.
- Do not drive or scrape on the curb.

Panels

Follow these guidelines to prevent scratches and damage:

- Wash gently with a sponge and plenty of water.
- Clean with diluted detergent and rinse thoroughly with enough water to remove stubborn dirt.
- Avoid putting gasoline, brake fluid, or stain remover on gauges, panels, or headlights.

Exhaust pipe and muffler

Exhaust pipes and mufflers are made of stainless steel, but can also be dirty from mud or dust. Wet sponges can be dipped in liquid friction to remove mud or dust, and then carefully rinse with clean water. Dry with suede or a soft towel. If necessary, burn marks can be removed with a fine-grained compound and then rinsed in the same way mud and dust are removed.

If the exhaust pipe and muffler have been painted, use a neutral stain remover to clean the finish of the exhaust pipe and muffler. If you are not sure if the exhaust pipe and muffler have been painted, contact a repair shop.

NOTE

Even though the exhaust pipe is made of stainless steel, it can rust. Once found, remove all traces and dirt immediately.

Storage of motorcycles

If you leave your motorcycle outdoors, you should consider using a motorcycle body shield.

If you don't ride for a long time, follow these guidelines:

- Clean the motorcycle and wax all paint surfaces except matte finish. Apply antirust oil to all chrome plated parts.
- Lubricate the drive chain.
- Place the motorcycle on the maintenance bracket and raise it with a wooden block so that both tires are off the ground at the same time.
- After it rains, remove the body shield to dry out the motorcycle.
- Remove the battery to prevent discharge.

Fully charge the battery and store in a cool, well-ventilated place.

- ▶ If you keep the battery in place, disconnect the negative terminal to prevent discharge.

Check all items specified in the maintenance schedule before reusing stored motorcycles.

Transportation of motorcycles

If you need to transport your motorcycle, you should use a motorcycle trailer or a flatbed truck or trailer with a ramp or lifting platform, and motorcycle straps should be used. Never attempt to tow a motorcycle with its wheels on the ground.

NOTE

Towing a motorcycle can seriously damage the transmission.

Environment

Owning and riding a motorcycle is a lot of fun, but you must do your part to protect the environment.

Choose the right detergent

Use a biodegradable stain remover when cleaning your motorcycle. Avoid sprays containing chlorofluorocarbons (CFCs), which can damage the atmosphere's protective ozone layer.

Waste recycling

Place motor oil and other toxic waste in approved containers and take it to a recycling center. Call your local or national public service or environmental services office to find a recycling center in your area and instructions on how to dispose of non-recyclable waste. Do not dump used engine oil into garbage cans or drains or on the floor. Used oil, gasoline, coolant and cleaning solvents contain toxic substances that can harm cleaners and pollute drinking water, lakes, rivers and the sea.

VIN (vehicle identification number)

The frame and engine number are unique to identify your motorcycle and are required to be provided when registering the motorcycle. This may also be required when ordering replacement parts. Please record these numbers and keep them in a safe place.

VIN

The frame number is engraved on the left side of the frame.



VIN



Engine No

Nameplate

The nameplate is pasted on the right side of the frame.



nameplate

Catalytic Converter

The motorcycle is equipped with a three-way catalytic converter. Catalytic converters contain precious metals as high-temperature chemical reaction catalysts to convert hydrocarbons (HC), carbon monoxide (CO) and nitrogen oxides (NOx) in the exhaust gas into a regulatory mixture.

Faulty catalytic converters can pollute the air and degrade your engine performance. Make sure to use the original parts for replacement.

Follow these guidelines to protect your motorcycle's catalytic converter:

- Use only unleaded gasoline. Leaded gasoline can damage catalytic converters.
- Keep the engine in good running condition.
- If the engine does not fire, backfire, stall, or otherwise malfunction, stop riding and turn off the engine.

Give the motorcycle to the repair shop for repair.

Technical Parameters

Vehicle model	NK300	Engine Model	Z268MN
overall length	1940mm	cylinder diameter X Stroke	68.0X44.2mm
overall width	825mm	Compression Ratio	11.2: 1
Overall Height	1075mm	Maximum net power	29 ± 5%kW/10500 ± 500(r/min)
Axle distance	1370mm	Maximum Torque	28 ± 5% N·m/9000 ± 500(r/min)
Wheelbase	/	Idling speed	1400 ± 100 (r/min)
Vehicle quality	149kg	Piston Swept Volume	322ml
Payload	150Kg	Sparking Plug	CR8E(NGK)
Front tyre specification	110/70R17	Spark Plug Gap	0.7~0.8mm
Rear tyre specification	150/60R17	Valve Clearance	Inlet valve: 0.16 ± 0.03mm
Maximum speed	170km/h		Outlet Valve: 0.27 ± 0.03mm

Vehicle model	NK300	Vehicle model	NK300
lubricating oil capacity	2.4L	Main fuse	30A
gasoline capacity	13L	Headlamp	LED
Primary gear ratio	3.043 (70/23)	Front Position lamp	LED
first gear	2.5 (35/14)	Rear position light/brake light	LED
second gear	1.824 (31/17)	front directional	LED
third gear	1.348 (31/23)	rear directional	LED
fourth gear	1.087 (25/23)	neutral light	LCD
fifth gear	0.920 (23/25)	rear license plate lights	LED
sixth gear	0.800 (24/30)	Turn indicator	LCD
Final gear ratio	3.071	Instrument indicator	LCD
Battery	12V 3Ah (锂电池)	method of ignition	ECU controls ignition

Torque parameters

Fastener type	Torque	Fastener type	Torque
5mm screw bolt and nut	6	6mm screw bolt	8
6mm screw bolt and nut	8	6mm flange bolts (8mm head: small flange)	10
8mm screw bolt and nut	22	6mm flange bolts (8mm head; large flange)	12
10mm screw bolt and nut	60	6mm flange bolts (10mm head) and nuts	12
12mm screw bolt and nut	80	8mm flange bolts and nuts	22
5mm screw bolt	5	10mm flange bolts and nuts	60

NOTE

Except for the specified torque, this motorcycle adopts the standard torque value in the table above.

Frame tightening torque

Items	Diameter of Thread (mm)	Torque (N. m)	Remarks
The bolt connecting the ECU to the front section of the rear fender	M5	5	
Screw connecting front gear ring to front wheel	M5	3	
Screws for the throttle line pressure plate	M5	1	
Screws for connecting the headlight back cover to the headlight bracket	M5	4	
The screw connecting the pedal decoration and the main pedal support	M5	4	
Screws for the instrument to connect to the instrument bracket	M5	4	
The screw connecting the taillight to the frame	M5	4	
Nut connecting oil pump and fuel tank	M5	6	
Nut for connecting license plate light to rear fender	M5	2	
The screw connecting the rear ring and the rear disc brake	M5	5	
Screws connecting the rear mudguard to the rear mudguard lining	M5	5	
Screws connecting the left and right body to the battery box	M5	5	
Bolts for connecting the instrument bracket to the upper connecting plate	M6	12	
The bolts that connect the mounting holes on the tank to the frame	M6	5	
Bolts for connecting ABS to ABS bracket	M6	12	
The bolt that connects the horn to the frame	M6	12	
Bolt connecting rear brake oil cup to frame	M6	8	
The bolt connecting the carbon tank bracket to the frame	M6	12	
The bolt connecting the seat lock to the frame	M6	8	
Bolts connecting headlight to headlight bracket	M6	8	
The bolt connecting the water tank to the frame	M6	8	
Bolts that connect the mounting holes under the water tank to the frame	M6	8	
Bolt connecting rear brake main pump to right front pedal bracket	M6	12	
The bolt connecting the rod end bearing of the rear brake main pump to the brake arm	M6	12	

Items	Diameter of Thread (mm)	Torque (N. m)	Remarks
The bolts connecting to the frame at the rear of the air filter	M6	8	
The bolt connecting the shift rocker arm to the engine	M6	8	
The bolt connecting the rod end bearing of the gearshift lever to the gearshift swing arm	M6	12	
The bolt connecting the rod end bearing of the gearshift rod to the gearshift pedal	M6	12	
Bolts for connecting headlight bracket and upper connecting plate	M6	8	
Bolts connecting the front of the fuel tank to the frame	M6	8	
The bolt connecting the small sprocket cover of the engine to the engine	M6	8	
The bolt connecting the left bracket of the engine lower fairing to the engine	M6	12	
The bolt connecting the right bracket of the engine lower air fairing to the engine	M6	12	
Bolts connecting the ABS bracket to the frame	M6	8	
Bolts connecting the regulator to the regulator bracket	M6	12	
Screws connecting the front brake tubing disc brake tee to the lower connection plate	M6	8	
Screw for rear brake return spring bolt connection	M6	8	
Screws for installing the front and rear ABS sensors	M6	8	
The screws connecting the left and right fuel tank side shields to the frame	M6	8	
The screw connecting the fuel tank Middle Protecting Plate and the fuel tank side Protecting Plate	M6	8	
The screws on the left and right body connected to the frame	M6	8	
The screw that connects the battery box to the frame	M6	8	
The screw connecting the rear shock absorber fender to the frame	M6	8	
Screw for connecting chain box to fork	M6	8	
Screws for the sprocket shroud (bottom) to connect with the flat fork	M6	8	
Screws for the front fender to connect to the shock absorber	M6	8	
Screws connecting the car body to the front section of the rear fender	M6	8	
The screw that connects the ignition lock cover to the frame	M6	8	

Items	Diameter of Thread (mm)	Torque (N. m)	Remarks
The screw connecting the lower fairing to the fairing bracket	M6	8	
The screw connecting the muffler cover to the muffler	M6	8	
The screws connecting the left and right side Protecting Plate of the fuel tank to the frame	M6	8	
Screw connecting oil rail to throttle	M6	8	
Screw for sprocket guard (top) to connect with flat fork	M6	8	
Screws connecting the billboard to the rear fender	M6	6	
The screw connecting the voltage regulator bracket and the frame	M6	4	
Screw connecting the rear disc brake tubing with the fork	M6	6	
The screw connecting the chain guard to the fork	M6	6	
The nut for adjusting the connection of the shift lever	M6	5	
The nut connecting the billboard to the rear fender	M6	6	
Bolts with flat washers connecting the rear section of the rear fender to the frame	M6	8	
The nut for adjusting the connection of the shift lever	M6 (left rotation) 5mm thick	5	
Rear brake pump rod end bearing adjustment nut	M6 (left rotation) 5mm thick	5	
Screws for the rear disc brake disc to connect to the rear axle	M7	20	
Bolts connecting the left and right support plates of the fuel tank to the frame	M8	22	
The bolt connecting the rear support plate of the tank to the left and right support plates of the tank	M8	22	
The bolt that connects the ignition lock to the frame	M8	22	
Bolts connecting fuel tank (rear) to frame	M8	22	
Bolts connecting the rear handrail to the frame	M8	22	
The bolt connecting the front section of the muffler to the frame (left side)	M8	22	
Bolt connecting rear brake caliper to caliper bracket	M8	22	
The bolt connecting the front section of the muffler to the frame (right side)	M8	22	
The bolt connecting the rear section of the muffler to the rear pedal	M8	22	

Items	Diameter of Thread (mm)	Torque (N. m)	Remarks
The screw that locks the front shock absorber to the front axle	M10	55-65	
The screws that connect the rear seat mounting glue to the frame	M8	22	
screw connecting handle bar upper holder and upper connecting plate	M8	22	
Screws for locking connection of upper connecting plate	M8	15-18	
Screws for locking connection of lower connecting plate	M8	12-15	
The screw connecting the front disc brake to the front wheel	M8	30	
Double-ended threaded column connecting the handle bar lower holder and upper connecting plate	M8	M10-30n. m/M8-22n. m	
Bolts connecting the left and right support plates of the fuel tank to the frame	M8	22	
The nut connecting the double-ended screw with the upper connecting plate	M8	22	
The nut connecting the muffler to the engine	M8	22	
Screws connecting the front pedal bracket to the frame	M8	22	
Screws connecting the front pedal bracket to the frame	M8	22	
The screw connecting the brake arm to the main pedal bracket	M8	22	
The screw connecting the shift arm and the main pedal bracket	M8	22	
The oil-passing bolt connecting the rear brake inlet and outlet pipes to the ABS	M10	22	
The oil-passing bolt connecting the front brake oil pipe and the ABS	M10	22	
Oil spill bolt connecting front brake oil pipe and left front caliper	M10	22	
Oil spill bolt connecting front brake oil pipe and front brake pump	M10	22	
Oil spill bolt connecting rear brake hose to rear brake caliper	M10	22	
Bolts attached to the upper left engine suspension	M10	60	
Bolts attached to the front left engine suspension	M10	60	
Bolts connecting the side bracket mounting plate to the frame	M10	60	
Engine right front suspension connection bolt	M10	60	
Engine right upper suspension connection bolt	M10	60	

Items	Diameter of Thread (mm)	Torque (N. m)	Remarks
Bolts attached to the rear shock absorber to the frame	M10	60	
Screw connected to flat fork under rear shock absorption	M10	60	
Front axle locking bolts	M10	60	
Bolts connecting the side bracket to the side bracket mounting plate	M10	2	
The screw connecting the front brake pump and the front shock absorber	M10	45	
The nut connecting the side support to the side support mounting plate	M10	22	
Nut connecting buffer bracket and chain disk	M10	60	
Nuts attached to the frame connection on rear shock absorption	M10	60	
The bolts connecting the rear upper suspension of the engine	M12	68	
The bolt connecting the rear lower suspension of the engine	M12	68	
Eccentric Wheel locking bolt	M12	35	
Nuts for engine rear suspension connection	M12	68	
Bolts connecting the upper link plate to the steering column	M14	80	
Nut for flat fork shaft connection	M16	88	
4-slot adjustment nut for steering column adjustment connection	M25	The first stage is 40n. m, the second stage is loosened for two turns and the nut is tightened to 10N.m, and the third stage is fixed in the direction of 1/4 turn	