

This operation manual introduces the main specifications, basic structure, adjustment methods and maintenance knowledge of the motorcycle. This manual will guide you to master the basic operation method of the motorcycle, as well as the ability to eliminate common faults, can effectively guarantee driving safety, reducing motorcycle faults, approaching the best performance of the motorcycle, improve the service life of the motorcycle.

This operation manual contains the introduction of the basic configuration of the motorcycle. Due to the further improvement, user demand and design improvement, the actual motorcycle may have some differences from this manual. We sincerely apologize for any inconvenience caused.

This instruction manual is one of the necessary accessories of this motorcycle. When the motorcycle is resold to others, it should be delivered with the motorcycle. The copyright of this manual belongs to the company. No reproduction is allowed without the written consent of the company. All rights reserved.

To ensure your safety and increase your riding pleasure:

- Please read this instruction manual carefully.
- Follow all the recommendations and instructions in this manual.
- Please pay close attention to the safety information recorded in this manual and pasted on the motorcycle body.

Safety Note

The safety of you and others is very important, and it is an important responsibility to ride your motorcycle safely.

To help you make an informed decision about safety, we provide steps and other information on the safety label and in this manual, which is intended to alert you to potential dangers that may harm you or others.

Of course, it would be impractical or impossible for us to list all the hazards associated with motorcycle riding and maintenance, and you must make the correct judgment yourself.

- Safety label on a motorcycle;
- A security message preceded by a security warning symbol  and one of the following three warnings: danger, warning, careful.

The meanings of the three warnings are as follows:

Danger  — Failure to comply with the instructions could result in serious loss of life.

Warning  — Failure to comply with the instructions could result in serious loss of life.

Careful  — If you don't follow the instructions, you may get hurt.

NOTE Information that helps you avoid damaging your motorcycle, other property, or the environment.

Content

Motorcycle safety	5
Operation guide	17
Maintenance	27
Fault handling	53
Relevant information	65
Technical parameters	75

Motorcycle safety

This section contains the motorcycle safety riding important information, please read this section carefully.

Safety guidelines	5
Security considerations	8
Riding note	9
Accessories and modifications	13
Loading guide	14

Safety guidelines

To enhance your ride safety, please follow the following guidelines:

- Perform all daily and routine inspections specified in this manual.
- Shut off the engine before refueling the tank, away from sparks and open flames.
- Do not start an engine in a confined or semi-confined space, as carbon monoxide in exhaust fumes is toxic and can be fatal.

Always wear a helmet

Helmets and protective clothing have been shown to significantly reduce the incidence and severity of head and other injuries. Therefore, always wear a certified motorcycle helmet and protective clothing.

Before riding

Make sure you and your fellow passengers wear certified motorcycle helmets and protective clothing. Instruct your rider to hold on to the rear handrail or to hold on to your waist, lean in with you when you turn, and keep your feet on the pedals, even when the bike is stopped.

Take time to learn and practice

Even if you have ridden other motorcycles, practice riding this motorcycle in a safe area to familiarize yourself with the way the motorcycle operates and to adapt to its size and weight.

Be defensive when you ride a bike

Keep an eye on the cars around you and don't assume that other drivers can see you. Always be prepared to slam on the brakes or detours.

Make yourself more visible

Especially at night, wear bright reflective clothing to stand out, park in a position where other drivers can see you, signal before turning or changing lanes, or honk your horn if necessary to alert pedestrians.

Don't drink then ride

Never ride beyond your personal abilities or faster than conditions allow. Fatigue and neglect can impair your ability to make sound judgments and ride safely.

Keep your motorcycle safe

It is important to properly maintain your motorcycle and keep it in good condition at all times. Check your motorcycle before each ride and complete all recommended maintenance and repairs. Overloading is strictly prohibited. Do not modify the motorcycle or install accessories that will affect its safety.

Handling unexpected events

Personal safety is your first priority. If you or anyone else is injured, carefully assess the severity of the injury and determine whether it is safe to continue riding. Call for emergency assistance if necessary. If a collision involves other people or a motorcycle, the applicable laws and regulations should also be followed.

If you decide to continue riding, first turn the ignition to the  (off) position and then evaluate the condition of the motorcycle. Check for oil leaks, check key nuts and bolts for fastening, and check handlebars, direction columns, brakes and wheels. Please ride slowly and carefully. Your motorcycle may have suffered damage that will not be immediately apparent. Please send it to motorcycle Service shop or a qualified repair shop for thorough inspection as soon as possible.

Carbon monoxide hazard

The exhaust gas contains poisonous carbon monoxide. Carbon monoxide is a colorless, odorless gas that can cause a person to lose consciousness when inhaled and can even be fatal.

If you start an engine in a confined or semi-confined space, the air you breathe may contain dangerous amounts of carbon monoxide.

Do not start the engine in a garage or other confined space.

Warning

Running a motorcycle's engine in a confined or semi-confined space can lead to a rapid accumulation of toxic carbon monoxide gas.

Inhalation of this odorless, colorless gas can cause rapid loss of consciousness and death.

The engine of a motorcycle is to be operated only in a well-ventilated outdoor area.

Security considerations

- Drive carefully with hands on handlebars and feet on pedals.
- Let the passenger in the process of driving be sure to hold tight after handrail or hold tight your waist, and put your feet on the pedal.
- Always be aware of the safety of your fellow riders and other drivers and riders on the road.

Protective suit

Make sure you and any passenger wear a certified motorcycle helmet, goggles, and eye-catching protective clothing. Ride carefully according to the weather and road conditions.

Helmet

Certified by safety standards, eye-catching, size to your head size.

- It must be safe and comfortable and secured with a chin strap.
- Masks or other approved goggles that do not obstruct sight.

Gloves

High wear resistance all finger leather gloves.

Boots or a riding shoes

A strong, non-slippery boot that protects the ankle.

Clothing

A bold protective long sleeve shirt and durable trousers (or protective suit) suitable for riding.

Warning



Not wearing a helmet increases the chance of serious injury or death in a crash.

Ensure that you and your passengers are wearing certified helmets and protective clothing at all times.

Riding note

Period

Follow these guidelines for the first 500km to ensure reliability and performance later.

- Avoid full throttle start or rapid acceleration.
- Avoid emergency braking and fast gear reduction.
- Ride carefully.

Brake

Follow the following guidelines:

- Avoid excessive emergency braking and gear reduction.
 - ▶ Your sudden braking will reduce the stability of the motorcycle.
 - ▶ Please slow down before turning if conditions allow, or you risk slipping.
- Be careful when driving on slippery roads.
 - ▶ I believe it's easier to taxi on the ground and requires a longer braking distance.
- Avoid continuous braking.
 - ▶ I believe in the long and steep slope downhill, the repeated braking will lead to serious overheating of the brake, the impact. Braking effect. With the aid of engine brake, brake should be used intermittently to slow down.
- The front and rear brakes can be used at the same time to achieve complete braking effect.

I Anti-lock braking system (ABS)

This model is equipped with an anti-lock braking system, which prevents the brake from locking up during emergency braking.

- Antilock braking systems do not reduce braking distance.

In some cases, antilock braking systems may result in longer stop braking distances.

- If the speed is less than 10km/h, the anti-lock braking system will not work.
- The brake lever and pedal may bounce slightly during braking. This is normal.
- Be sure to use the recommended tires to ensure that the abs works properly.

I Engine braking

When you take off the throttle, the engine braking helps to slow the motorcycle down. If you want to go slower, you can slow down to lower gear. The use of brakes intermittently to slow down long and steep slopes with the aid of engine braking.

I Moist and rainy environment

In a wet environment, the road will be slippery, and the wet brake more reduce the braking efficiency, in the wet braking should be particularly careful.

If the brake becomes wet, you can use the brake at low speeds to help dry the brake quickly.

Parking

- Stop on solid, flat ground.
- If you must stop on slightly tilted or loose ground, make sure to stop firmly and prevent the motorcycle from moving or toppling over.
- Ensure that high-temperature components do not come into contact with flammable materials.
- Do not touch engine, muffler, brake and other high temperature parts before cooling.
- To avoid the possibility of theft, be sure to lock and pull the handlebars before leaving an unattended motorcycle, Lose your motorcycle keys.

■ Parking with a lateral support

1. Shut off the engine.
2. Lower the side bracket.
3. Slowly tilt the motorcycle to the left until its weight is concentrated on the side bracket.
4. Turn the handlebars completely to the left.
 - ▶ If You turn the handlebar to the right, it will reduce stability and may cause the motorcycle to fall.
5. Turn the ignition switch to the  (locked) position and remove the motorcycle keys.

Refueling and fuel guide

Follow these guidelines to protect your engine and catalytic converters:

- Use only unleaded gasoline.
- Use the recommended octane number. Using low octane gasoline can degrade engine performance.
- Do not use fuel containing high concentrations of alcohol.
- Do not use spoiled or contaminated gasoline, or oil and gasoline mixtures.
- Prevent dirt and water from entering the tank.

Accessories and modifications

We strongly recommend that you do not add any accessories other than those designed specifically for your motorcycle or modify the original design of the motorcycle. Doing so will make the motorcycle unsafe. Modifications to your motorcycle may also invalidate your warranty and cause your motorcycle to be unable to drive legally on public roads and highways. Before you decide to add accessories to your motorcycle, determine which modifications are safe and legal.

Warning



Improper fittings or modifications may cause a crash in which you may be seriously injured or even life-threatening.

Follow all instructions in this Instruction manual regarding accessories and modifications.

Do not attach a trailer or straddle bucket to the motorcycle. Your motorcycle is not designed for these parts.

Their use can seriously damage the maneuverability of a motorcycle.

Loading guide

- Carrying extra load can affect the handling, braking and stability of a motorcycle. When a heavy load is carried, be sure to maintain a safe speed while riding.
- Avoid overloading and stay within specified loading limits. Maximum payload is 366kg.
- Tie all luggage tightly and place it evenly and smoothly near the center of the motorcycle.
- Do not place items in headlights or mufflers.

Warning



**Overloading or improper loading can lead to accidents and serious injuries.
Please follow the loading limits and other loading instructions in this Instruction manual.**

Parts location

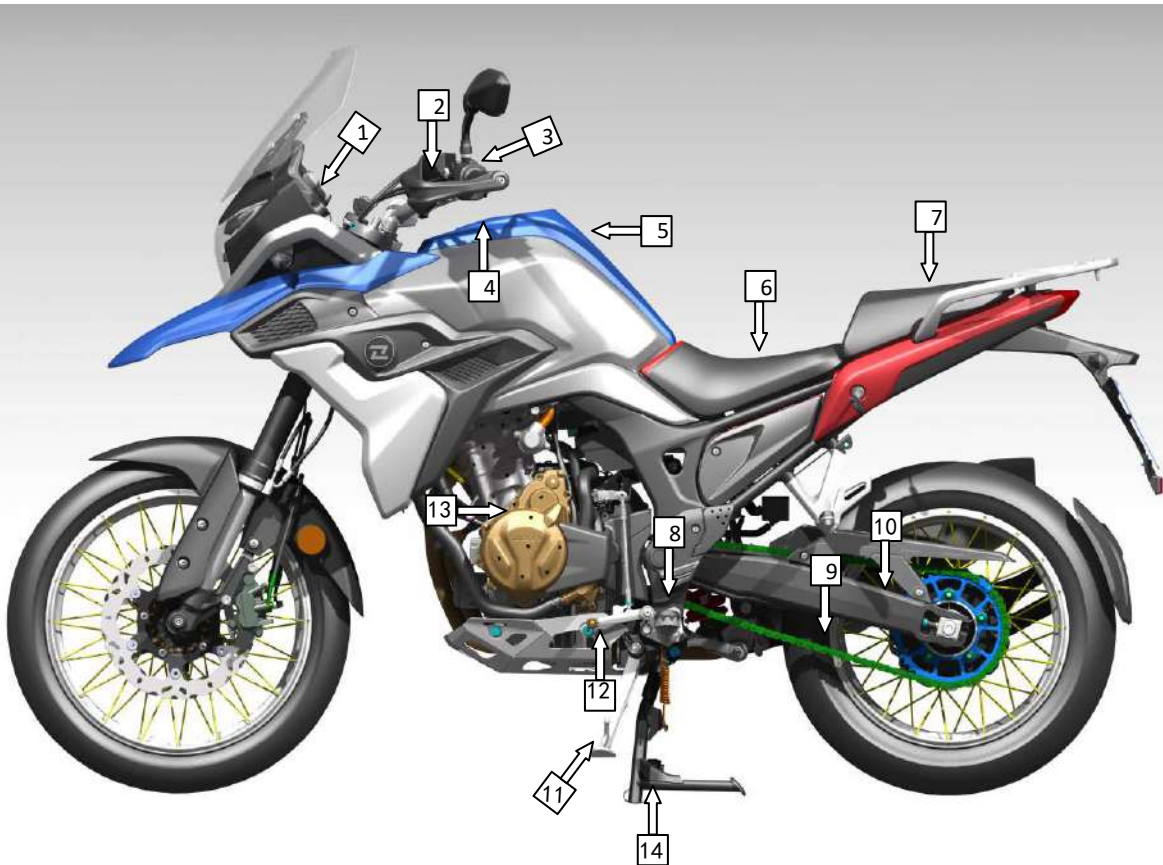

1. Speedometer Assy
(instrument)
2. Lever, Clutch
3. Handlebar switch-left
4. Fuel Tank Lock
5. Fuel Tank
6. Seat Assy (Front)
7. Seat Assy (Rear)
8. Front pedal assembly-left
9. Chain
10. Rear Arm
11. Side Stand
12. Pedal, Gear Shift
13. Engine
14. Main stand

Parts location



1. Rear View Mirror

2. Front brake fluid tank

3. Brake Handle

4. Handlebar switch -

right

5. Engine oil injection cap

6. Rear brake pedal

7. Front pedal assembly -

right

8. Muffler Assy

Operation guide

instrument

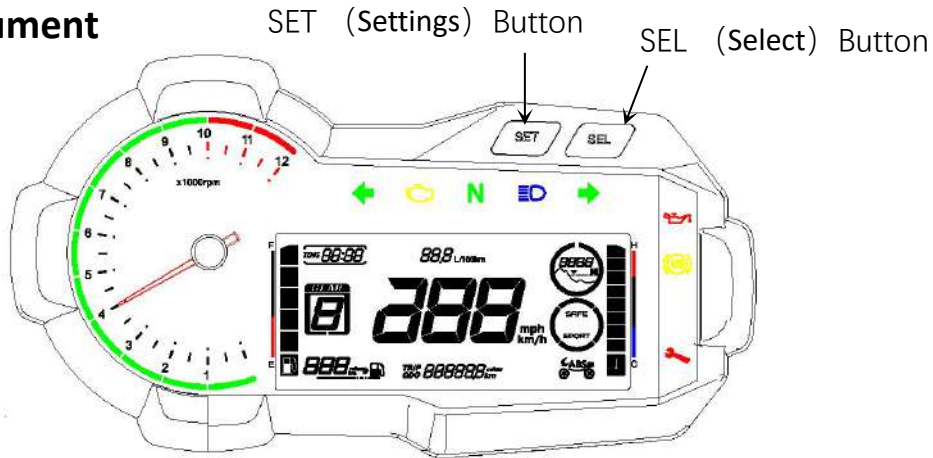

According to check

When the ignition switch is switched to  (on), all modes and numeric bars appear. If any part of the display area should be displayed but is not displayed, please refer to the special repair shop for maintenance.

Item	Name	Remark
①	Tachometer	Engine speed indication (r/min)
②	Time display	Show time
③	Steering light	When the steering switch is placed on the left, the left indicator lights up When the steering switch is placed on the right, the right indicator lights up
④	Electronic injection system failure status indicator light	This light will be on when the electric jet breaks down
⑤	Neutral indicator light	This light is displayed when in neutral
⑥	High beam indication	This light displays when the high - light indicator is turned on
⑦	Oil indicator	This light comes on when the oil is low
⑧	ABS antilock	The light comes on when something goes wrong
⑨	Maintenance service warning	When the mileage reaches 500km, the indicator light goes on for the first time, the mileage reaches 1500km, and the indicator light goes on for the second time. The operation is then performed every 5000km. When the maintenance service warning light is on, long press "SEL+SET" button at the same time to turn off the indicator light or continue to drive 500km to turn off. (service miles may be set to differ in different countries or area)

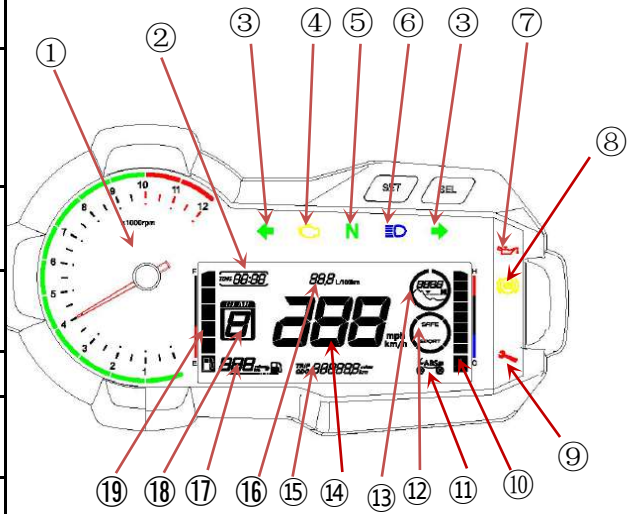

Item	Name	Remark
⑩	Water temperature display	Water temperature display (the third panel shows normal water temperature, the fourth panel shows high water temperature, the fifth panel shows too high water temperature, stop immediately;Wait for the water to cool.)
⑪	ABS status display	ABS is working status display
⑫	Power mode display	Safe mode (SAFE) 、 Sport mode (SPORT)
⑬	Altitude display	Display altitude (Display accuracy error +- 100m)
⑭	Speed table	Displayed in Km/h
⑮	Speedometer	Display the mileage of the motorcycle
⑯	Fuel consumption	Show fuel consumption
⑰	Remaining odometer	Current fuel consumption and remaining mileage
⑱	Gear display	Displays the gear status
⑲	Fuel indicator	Fuel quantity display

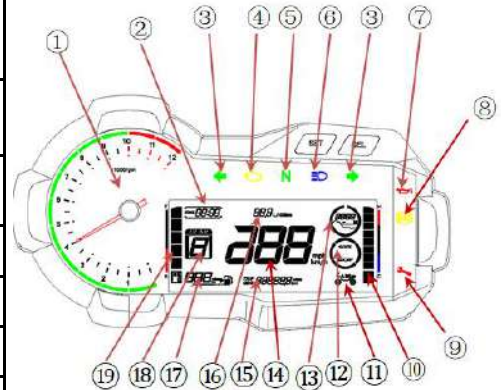

The functions of the instrument are as follows:

1、 "SET" key:

Short press:(1) Non-clock interface: ①ODO-->TRIP-->ODO switching;

(2) Clock setting interface: ① Corresponding to the clock setting plus 1;

Long press: (1) Non-clock interface: ①Under the ODO interface, average fuel consumption reset;

②In the TRIP interface, clear 0 for the subtotal mileage;

(2) Clock setting interface: ①Clock hour-->clock minute-->exit clock setting shift selection;

2、 "SEL" key:

Short press:(1)Sport mode selection interface:①"SAFE"-->"SPORT"-->"SAFE"cycle between modes;

(2)ABS mode selection interface:① "ABS fully open"-->"Separately close the rear wheel"-->"ABS all off"-->"ABS fully open", Cycle switch;

Long press:(1)Maintenance light is not working:①Switch between sports mode switching and ABS switching mode;

(Enter the ABS mode selection interface)

(2)Maintenance light work:①Turn off the maintenance reminder light;

3、 Long press "SET" and "SEL" at the same time: ①Enter the clock setting interface;

4、 Press and hold the "SET" button on IGN to switch between metric and imperial systems;

5、 5S does not operate the button, exit the clock mode, or exit the ABS control mode

Note

You must select ABS mode in the stop state.

Switch

Right handle switch

Emergency extinguishing switch

Should be in  (running) position under normal circumstances.

- ▶ In an emergency, switch to  (stop) position to shut off the engine.



Electric start button



In Non-EU version, it has deadlight switch, off/low/high beam

The electric start button is located below the light switch, when the emergency flameout switch is placed in position “” :

- ① The engine is in neutral. Press this button to start the engine.
- ② If the engine is not in neutral, you need to fold up the side support and pinch the clutch handle, press this button can also make the engine start.

Left hand switch



Overtaking switch

Near-far light switch



The headlight is in high light



The headlight is in near light

Emergency light switch

Emergency use

Horn button

Turn signal switch



Left turn on - the steering light is set to the left.

After operation, the turn signal switch returns to its original position.



Right turn on - turn indicator is set to right.

After operation, the turn signal switch returns to its original position.

Note: Press the turn signal switch button to turn off the turn signal.

Ignition switch

Position	Action	Remark
⊗	Stop and use (disconnect all circuits)	Key extractable
○	Used when starting or running	The key can't be pulled out



Turn the direction to the far left, then turn the key to the "⊗" position, press in and turn counterclockwise until the "PUSH" position, and take out the key. To unlock, just turn the key clockwise.

Warning

When parking (including parking for a long time), the ignition switch must be placed in the position of "⊗" or "PUSH" to ensure the motorcycle safety and prevent the battery from "running OFF". In the steering mechanism locked state, absolutely can not push the motorcycle, otherwise it will lose its balance.

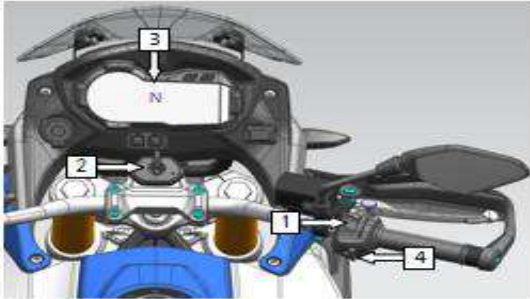

Starting engine

Whether the engine is hot or cold, follow the instructions below to start the engine.



Note:

- If the engine fails to start within 3 seconds, turn the ignition switch to the OFF position. Wait 10 seconds and start the engine again after the battery voltage is restored.
- Hard refueling doors or high speed idling for more than 5 minutes may cause discoloration of exhaust pipes.
- Prolonged high idling and rotation can damage the engine and exhaust system.
- If the throttle is fully open, the engine will not start.

- ① Verify that the engine flame-out switch is in position  (running).
- ② Turn the ignition switch to  (on) position.
- ③ Change to neutral (N neutral indicator lights on). Alternatively, fold up the side bracket, pinch the clutch handle, and start the bike with the speedster on.
- ④ Press the start button if you turn off the throttle.

If the engine does not start:

- ① Fully open the throttle, and press the start button for 3 seconds.
- ② Repeat the normal starting procedure.
- ③ If the engine starts, idle instability, gently refueling door.
- ④ If the engine does not start, such as 10 seconds to repeat steps 1 and 2.

Shift

Your motorcycle has six forward gears with a shift mode of 1 down and 5 up.

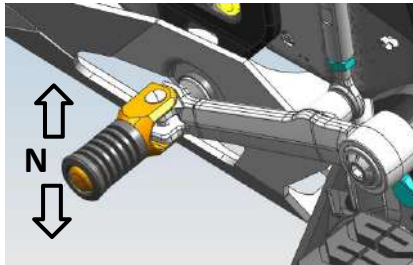

1-N-2-3-4-5-6

Things you should pay attention to while driving.

The method of shifting gears.

Preheat the engine to make it run properly.

(1) When the engine is at idle and takes off the clutch, the pedal changes gear pedal, so that the transmission into low gear (first gear) position.

(2) Gradually increase the engine speed, slowly release the clutch handle, the two movements with coordination, to ensure a natural start.

(3) When the motorcycle to reach the balance running state, reduce the engine speed and then take off the clutch, the upward gear change pedal into the second gear, and so on, the rest of the shift can be carried out by the same method.

1. Avoid unnecessary engine idling, and do not allow the engine to idling at high speed, otherwise the parts will be seriously damaged.
- 2, the clutch in the state of half separation running, will make the clutch disc wear quickly.
- 3, if you feel the engine power is insufficient when climbing, you should timely switch to low gear.
4. In driving, especially downhill and high-speed driving, it is not allowed to use the front brake or neutral taxi alone.
- 5, stop the motorcycle, should be small throttle, at the same time cut off the clutch, then brake.

Gasoline feeding

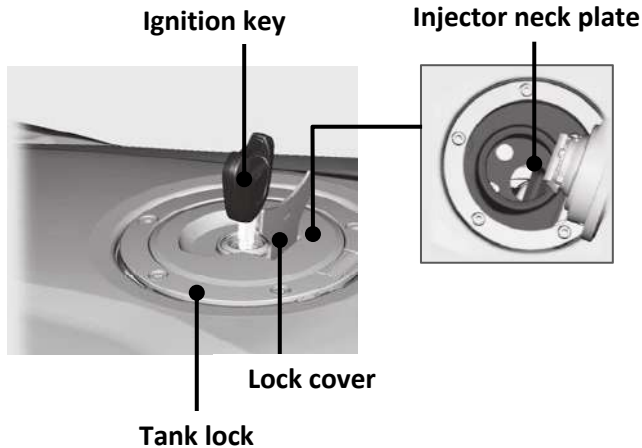

Open the gas cap

Turn the lock cover, insert the ignition key, and turn clockwise to open the fuel tank cover.

Close the tank cap

- ① After refueling, press the cap until it is locked.
- ② Remove the key and close the lock.
 - ▶ If the cap is not locked, the key will not come out.

Refueling shall not be higher than the injector neck plate. The fuel tank has a capacity of 20L. When filling, use the side bracket to stop and then open the lock cover of the fuel tank for filling. After fuel injection, close the lock cap and lock it.

It is recommended to use 95# unleaded gasoline.

Warning!

Gasoline is a very flammable and explosive substance. You may get burned or seriously injured while handling gasoline.

- Shut off the engine, away from heat, sparks, or open flames.
- Handle gasoline outdoors only.
- If any spill occurs, wipe it clean immediately.

Maintenance

Please read the "Importance of Maintenance" and "Maintenance Specification" carefully before preparing for maintenance.

Please refer to "Technical parameters" for maintenance data.

Importance of Maintenance	28	Side stand	47
Maintenance of periodic table	29	Driving chain	48
Maintenance specification	30	Clutch	50
Tool	39	Gas pedal	51
Remove and install body components	40	Headlight beam adjustment	52
Battery	40		
Seat	41		
Engine oil	42		
Cooling fluid	44		
Brake	45		

Importance of Maintenance

Importance of Maintenance

Keeping your motorcycle in a good state of maintenance is critical to your safety, as well as protecting your property, achieving optimal performance, preventing breakdowns, and mitigating air pollution. Maintenance is the responsibility of the motorcycle owner. Be sure to check before each ride and check regularly as described in the maintenance periodic table.

Warning!

Failure to perform proper maintenance prior to riding or to properly remove the malfunction can lead to serious injury or fatal accident.

Please always follow the inspection, maintenance advice and periodic table provided in this Instruction manual.

Safety of maintenance

Read the maintenance instructions before each service to make sure you have the necessary tools, components, and skills. We cannot warn you of every danger that may arise during maintenance. Only you can decide whether or not you should perform the maintenance.

Please follow the following guidelines for maintenance.

- Shut off the engine and remove the keys.
- Use side supports to park the motorcycle on solid and flat ground, or use maintenance supports for support.
- Please wait for engine, muffler, brake and other high temperature components to cool before starting operation, otherwise it may cause burns.
- Start the engine only under specified conditions and in a well-ventilated environment.

Maintenance of periodic table

The motorcycle should be maintained according to the prescribed maintenance time. The meanings of the symbols in the table are as follows:

I: Check, clean, adjust C: clean R: replace A: adjust L: lubricate

To ensure safety, the project can only be repaired by the company's special shop.

Maintenance item list

		Project	Odometer Km(note 2)			
		Cycle	1000Km	4000Km	8000Km	12000Km
*	FUEL LINE			I	I	I
*	FUEL FILTER					R
*	THROTTLE OPERATION		I	I	I	I
	AIR CLEANER	Note 1			R	
*	SPARK PLUG		I	I	I	I
	EXHAUST VALVE CLEARANCE		I	I	I	I
	INLET VALVE CLEARANCE		I	I	I	I
*	ENGINE OIL		500Km, 1500Km, replace every 5000Km thereafter. (it may be set to differ in different countries)			
*	ENGINE OIL FILTER		Replace the oil when you change it.			
*	TENSIONING OF TIMING CHAIN		A	A	A	A
	EFI SYSTEM			I	I	I
	DRIVE CHAIN			I, L	I, L	I, L
	BATTERY	Monthly	I	I		I
	BRAKE PAD WEAR			I	I	I
**	BRAKE SYSTEM		I	I	I	I
*	HEADLIGHT AIM		I	I	I	I
*	SUSPENSION		I	I	I	I
**	FASTENERS			I	I	I
**	STEERING HEAD BEARINGS		I	I	I	I

The motorcycle should be repaired and maintained according to the prescribed time. The various symbols in the table are defined as follows:

I: Check, clean and adjust

R: replace

A: adjust

L: lubrication

* : This item will be repaired by the maintenance station. If the user has special tools, repair parts and repair ability, he can also repair by himself. The maintenance knowledge can refer to this maintenance manual

** : To ensure safety, this project can only be serviced by staff

Note: 1. When driving in dusty areas, cleaning should be carried out frequently. 2. When the odometer reading exceeds a given maximum number. Gas maintenance cycle is still repeated according to the mileage interval specified in the table.

Maintenance specification

Importance of Maintenance

To ensure safety, it is your responsibility to conduct a pre-ride inspection and ensure that any problems you find are corrected. It is necessary to check before riding.

Project	Check the content
Direction	Flexible rotation, no clearance and looseness
Braking system	Check its health; Front and rear: Check brake fluid level and brake disc wear
Fuel level	Enough fuel to cover the planned distance (refueling if necessary)
Gas pedal	Check for smooth opening and complete closing in each steering position
Clutch	Check its health; Adjust your free itinerary if necessary
Wheels and tires	Check the service condition and tire pressure, and add air pressure if necessary
Driving chain	Check its service condition and sag, adjust and lubricate if necessary
Lighting, horn	Check that the lighting system and speakers are in good condition
Engine oil level	Add engine oil if necessary; Check for leaks
Instrument	Check whether the indicator lights on the instrument are displayed normally
Side bracket switch	Check that the function is normal

Replacement parts

To ensure reliability and safety, please use the original parts of the locomotive.

Battery

Your motorcycle is equipped with a maintenance-free battery. You do not need to check the amount of battery electrolyte and add distilled water. Clean the battery terminals if they become dirty or corroded.

Note

Your battery is maintenance-free.

Note

Improper handling of batteries may cause harm to the environment and human health. Be sure to confirm appropriate battery handling instructions in local regulations.

I Clean battery terminals

1. Take off the battery.
2. If the terminal has just corroded and is covered with a white substance, rinse and wipe clean with warm water.
3. If the terminals are seriously corroded, clean and polish them with a wire brush or sandpaper. Wear safety glasses when polishing.

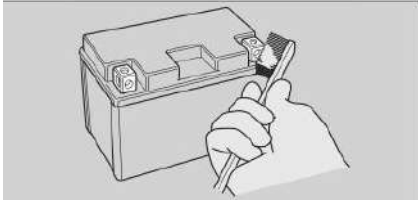

4. After cleaning, put it back into the battery.

Battery life is limited. Consult locomotive repair shop when you need to replace the battery. Be sure to replace the same type of maintenance-free battery.

Note

Installing electrical accessories that are not Part of a locomotive can overload the electrical system, causing batteries to discharge and possibly damaging the system.

Battery

The fuse protects the circuits on your motorcycle. If some electrical parts of your motorcycle stop working, check and replace the blown fuse.

■ Check and replace fuses

Turn the ignition switch to (off) position and take out and check the insure wire. If the fuse blows, replace it with a fuse of the same specification. Please refer to "Technical Parameters" for fuse specifications.

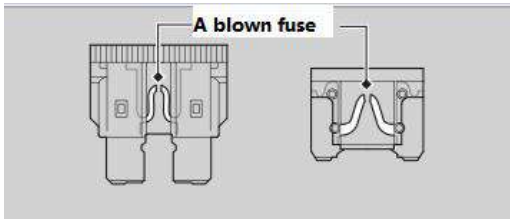

Note

Replacing a fuse with a higher rating increases the chance of damage to the electrical system. If the fuse blows often, there may be an electrical problem. Please let motorcycle repair shop repair motorcycle.

Engine oil

Engine oil consumption and oil degradation will vary depending on driving conditions and time of use.

Check the engine oil level frequently and add the recommended engine oil if necessary.

Dirty or old oil should be replaced as soon as possible.

■ Select engine oil

The oil should be SN grade or above classified by API.

Its brand number is 10W -- 40 SN.

Brake fluid

Do not add or replace brake fluid unless in an emergency. Use only newly extracted brake fluid from the sealed container. If you have added brake fluid, please check the brake system at locomotive Repair shop as soon as possible.

Note

Brake fluid can damage plastic and paint surfaces.
If there is any splash, wipe it off immediately and wash it thoroughly.

Recommended brake fluid:

DOT 4 brake fluid or equivalent

Driving chain

Drive chains must be inspected and lubricated periodically. Check the chain more frequently if it is often driven on poor quality roads, at high speeds, or at repeated high speeds.

If the chain doesn't run smoothly, or makes a strange sound, or there is a damaged roller or loose bolt, or the O-ring is lost or bent, please have it checked by .

Check both the driving sprocket and the driven sprocket. If any of them have worn or bad teeth, they should be replaced by locomotive repair shop.

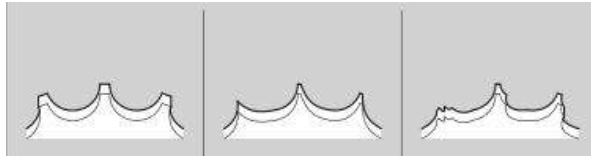

Normal
(Good)

Wear and tear
(Replace)

Damage
(Replace)

Note

Using a new drive chain on a worn sprocket will speed up chain wear. The drive chain and sprocket should be replaced simultaneously.

I Cleaning and lubrication

After checking the sag, clean the chain and sprocket while rotating the rear wheel. Use a dry cloth and O-ring chain cleaner or neutral stain remover. If the chain is dirty, use a soft brush. After cleaning, dry and lubricate with the recommended lubricating oil.

Recommended lubricating oil:

Special lubricating oil for O-ring chain

If not, use SAE 80 or 90 gear oil

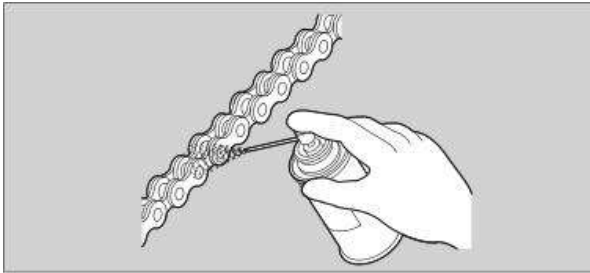

Do not use non-O-chain steam cleaners, high pressure cleaners, wire brushes, volatile solvents such as gasoline and benzene, linens, chain cleaners and lubricants, otherwise the O-ring seal may be damaged.

Avoid getting grease on brakes or tires. Avoid using too much lube oil to avoid splashing onto clothes or motorcycles.

Recommended coolant

Only original pre-mixed Clove locomotive coolant without water dilution can be used.

The pre-mixed coolant of the original locomotive is excellent for preventing corrosion and overheating.

Coolant should be properly checked and replaced in accordance with the maintenance periodic table.

Note

Corrosion can result from using non-aluminum engine coolant, regular tap water, or mineral water.

Tire (Inspection/replacement)

■ Check the tire pressure

At least once a month or at any time when you feel the tire pressure is low, visually inspect the tire and measure the tire pressure with a barometer. Check tire pressure as the tire cools.

■ Damage inspection

Check the tire for cut marks, cracks, exposed fabric or string, or for nails or other foreign matter embedded in the side of the tire or in the tread. Also check for any abnormal bulge or expansion on the side wall of the tire.

■ Abnormal abrasion test

Check the contact surface of the tire for signs of abnormal wear and tear.

■ Check the tread pattern depth

Check tread wear indication marks. If the wear reaches the indicated mark, change the tire immediately.

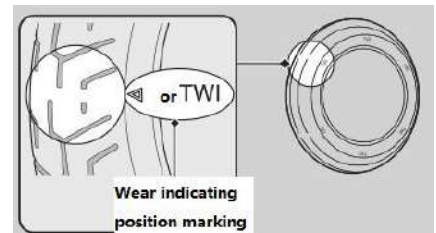

Warning

Excessive wear or improperly inflated tires can lead to accidents and serious injuries. Please follow the relevant tire inflation and maintenance instructions in the Operating Instructions.

Whenever changing a tire, follow the following guidelines:

- Use recommended tyres or the same products with the same size, structure, speed class and load.
- After the tire is installed, use the original locomotive balance locator or equivalent equipment to balance the wheel positioning.
- Do not install inner tubes in the tubeless tires of this motorcycle. Too much heat can cause the inner tube to burst.
- This motorcycle can only use tubeless tires. The rim is designed to use tubeless tires. During rapid acceleration or braking, a tire with an inner tube can slide over the wheel frame, causing a rapid air leak.

Warning

Improperly installed tyres can affect handling and stability and lead to accidents that can seriously injure you or even endanger your life. Be sure to use the size and type of tires recommended in this Manual.

Air filter

The motorcycle is fitted with a paper air filter element.

Do not maintain by yourself.

This will be cleaned or replaced by .



Air filter

Tool

The tools are stored under the seat cushion.

You can use onboard tools for some simple repairs, minor adjustments, and component changes.

- Double-headed screwdriver
- Double end spanner 8X10
- Double end spanner 12X14
- No. 5 inner hexagon wrench
- No. 6 inner hexagon wrench
- Low tail clamp
- Low tool bag

Remove and install body components

Battery



Positive terminal

Rubber belt

Negative terminal

Battery

Remove

Confirm ignition switch to  (off) position.

1. Remove seat cushion.
2. Loosen the rubber band from the back.
3. Disconnect the negative terminal of the battery.
4. Disconnect battery positive pole + terminal.
5. Remove the battery and be careful not to lose bolts

and nuts.

Installation

Install the parts in reverse order to disassemble. Be sure to connect the positive terminal first and the negative terminal last. Make sure the bolts and nuts are tight.

Seat

Remove

1. Insert the ignition key into the seat cushion lock.
2. Turn the key clockwise while pulling the back end of the seat up out of the lock, and then remove the seat from the top by leaning backward.
3. Loosen the mounting bolts of the front cushion assembly, and pull back to remove the front cushion assembly.

Installation

1. Insert the front support into the frame seat holder and tighten the bolts in the direction shown in the figure.
2. Insert the front and rear pins of the rear pad assembly into the frame card slots respectively.
3. Align the cushion lock pin with the lock hole, press the rear of the cushion downward, the lock pin is inserted into the lock hole of the cushion lock seat and is automatically locked by the lock tongue. Pull up slightly to ensure that the cushion is firmly locked in place. When the seat cushion is closed, the seat cushion lock is automatically locked.

Note

Please ensure that the middle seat bolt is inserted into the frame slot properly, otherwise the seat product will not be able to support your weight and the seat product may be crushed.

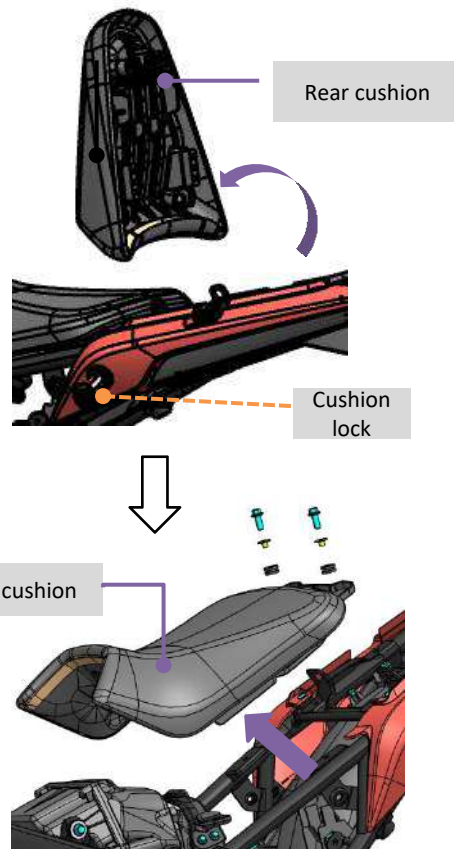

Engine oil

Check engine oil

1. Idle 3 to 5 minutes.
2. Turn ignition switch to  (off) position and wait 2 to 3 minutes.
3. Place the motorcycle vertically on a firm, flat surface.
4. Check the oil level from the engine oil level check port to see if it is between the upper and lower oil level marks.

Add engine oil

If the engine oil is below or near the lower oil level mark, add the recommended engine oil.

1. Remove engine oil injection cap.
Add the recommended oil to the upper oil level mark.

When I view the oil level, place the motorcycle vertically upward on the firmly flat ground. I believe the refueling do not exceed the ceiling oil level marker.

Ensure that there is no foreign matter entering the engine oil injection port.

If you spill anything, erase it immediately.

2. Reinstall the engine oil injection cap and tighten it.

Oil injection cap

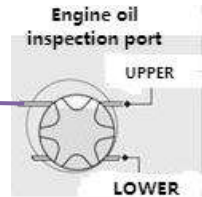
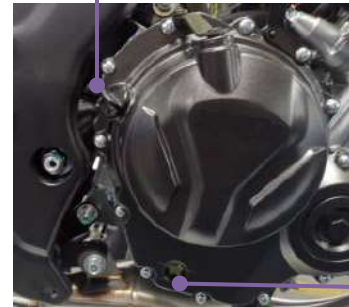

Note

Too much or too little oil can damage an engine. Do not mix different brands and grades of oil. This affects lubrication and clutch operation.

Refer to the "Maintenance Specification" for the recommended oil type and selection guide.

Change the engine oil and filter

Changing engine oil and filters requires special tools.

We recommend this to be done by Special maintenance.

Use your motorcycle's designated dedicated original engine oil and filters or equivalent.

Note

Using the wrong engine oil filter can seriously damage the engine.

1. If the engine is cold, idle for 3 to 5 minutes.
2. Turn ignition switch to  (off) position and wait 2 to 3 minutes.
3. Park the motorcycle on a firm level.
4. Place an oil drain pan under the drain bolt.
5. Remove engine oil injection cap, discharge bolt and sealing washer and drain oil.
6. Remove the engine oil filter with a filter wrench and drain the remaining oil. Make sure the old apron is not stuck to the engine.
 - ▶ Discard oil and filters at the recovery center.

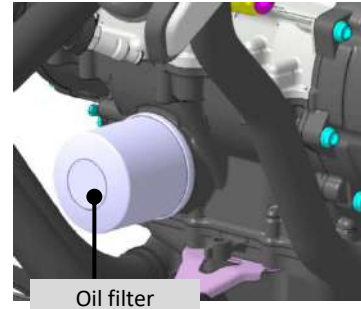

7. Apply a thin layer of engine oil to the rubber seal of the new filter.
 8. Install a new engine oil filter and tighten it. Torque: 26 N·m (2.7 KGF ·m, 19 LBF ·ft)
 9. Install a new seal gasket onto the drain bolt and tighten the drain bolt. Torque: 30 N·m (3.1 KGF ·m, 22 LBF ·ft)
 10. Add the recommended oil to the crankcase and install the oil injection cap.
- Amount of oil required When changing engine oil and filter:
2.7L
Engine oil change only: 2.5L
Check the oil level.
12. Check for oil leaks.

Cooling fluid

Check the coolant

Check the coolant level in the kettle during engine cooling.

1. Park the motorcycle on a firm level.
2. Keep the bike upright.
3. Check whether the coolant level in the storage kettle is between the upper and lower level marks.

If the coolant level drops significantly or the water bottle is empty, there may be a serious leak. Please let motorcycle repair shop repair motorcycle.

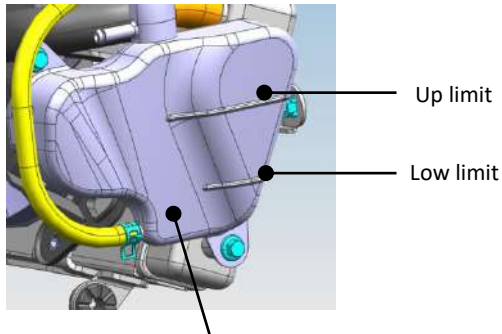

Add coolant

Store the kettle

If the coolant level is below the lower level mark, add the recommended coolant until the upper level mark is reached. Coolant can only be added from the cap of the storage kettle, and do not remove the cap of the radiator.

1. Remove the radiator cap, add the coolant and pay attention to the coolant level.

- ▶ Please don't exceed the limit.
- ▶ Make sure there is no foreign matter entering the radiator cap.

2. Replace the radiator cap.

Warning

Removing the cap from the radiator when the engine is hot will cause the coolant to squirt out, which may cause burns to you. Be sure to wait for the engine and radiator cooling before taking off the radiator cap.

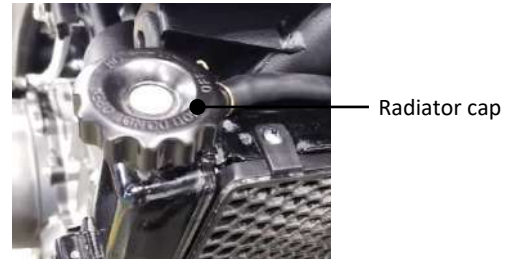

Replace coolant

Unless you have the right tools and technical expertise, please have the coolant to be replaced by .

Brake

Check brake fluid

1. Place the motorcycle vertically up on a firm, flat surface.
2. **前** Check whether the brake fluid storage tank is horizontal and the brake fluid level is above the lower limit mark (LWR).
后 Check that the brake fluid tank is horizontal and the brake fluid level is between the upper and lower limits.

If the brake fluid level in any of the storage tanks is below the LWR or LOWER level mark, or if the free stroke of the brake lever and pedal exceeds the limit, the brake disc must be checked for wear. If the brake disc is not worn, there may be leakage. Please have your motorcycle serviced or serviced by .



Lower limit(LWR)

Front brake fluid storage tank

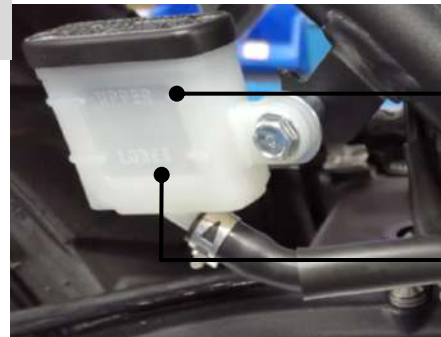

Up limit

Low limit

Check brake disc

Check the condition of brake disc wear indication marks.

If the brake disc is worn to the indicating mark, it needs to be replaced.

1. **Front** Check the brake disc from under the brake calipers.

Brake lining thickness:

Front Brake lining thickness:
4mm (indicating limit of wear)

2. **Back** Check brake disc from right rear of brake caliper.

Brake lining thickness:

Back Brake lining thickness:
4mm (indicating limit of wear)

If necessary, please submit to locomotive repair shop to replace the brake disc. The left and right brake plates must be replaced simultaneously.

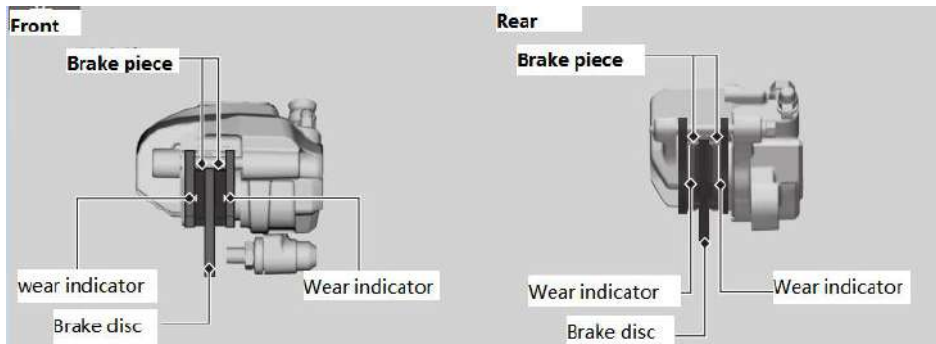

Side stand

Inspection side bracket

1. Check whether the side bracket can operate freely. If the side bracket operates stiffly or with a squeak, clean the pivot area and lubricate the pivot bolts with clean lubricating oil.
2. Check the spring for damage or loss of elasticity.
3. Sit on the motorcycle, shift into neutral, and raise the side bracket.
4. Start the engine, pinch the clutch handle and put the transmission into gear.
5. Lower the side bracket completely. The engine should stop when you lower the side bracket. If the engine does not stop, please submit to locomotive repair shop. Overhaul the motorcycle.

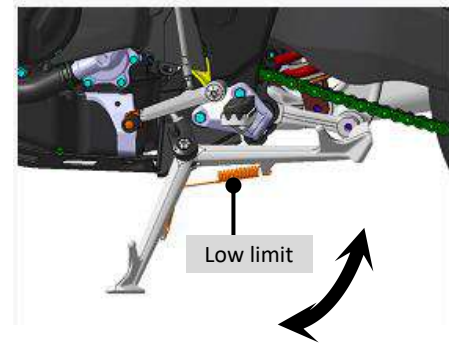

Driving chain

Check the sag of the drive chain

Check perpendicularity at different points along the chain. If not all points have the same sag, some of the links may have been bent and kinked.

Please check the chain by locomotive repair shop.

1. Put the transmission into neutral. Shut off the engine.
2. Position the motorcycle vertically on a firm, flat surface.
3. In the rear area of the chain guard, push the chain away from the flat fork to determine the sag of the chain.

Drive chain sag: 25-40mm

► If it's over 40 mm, you can't go on a motorcycle.

4. Turn the rear wheel forward to check whether the chain runs smoothly.
5. Check the sprocket.
6. Clean and lubricate the drive chain.

Note

When checking the drive chain sag, make sure that the upper part of the chain must be tensioned.

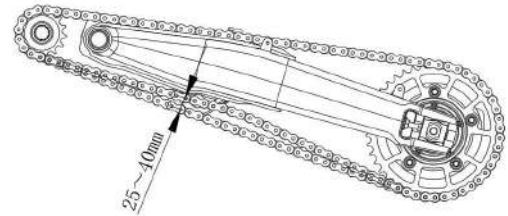

Adjust the sag of the drive chain

Adjust the drive chain sag

1. Put the transmission into neutral. Shut off the engine.
2. Position the motorcycle vertically on a firm, flat surface.
3. Loosen the rear axle lock nut.
4. Loosen the left and right chain adjuster lock nuts to loosen the chain adjuster.
5. Move the rear wheel back and forth (tighten the chain backward and loosen the chain forward) to adjust the chain tightness and check the chain sag.
6. In the rear area of the chain guard, push the chain in the direction of the flat fork to determine the reasonable sag of the chain.

Chain tightness: 25-40mm



Rear axle
fixing nut

Chain adjuster
fixing nut

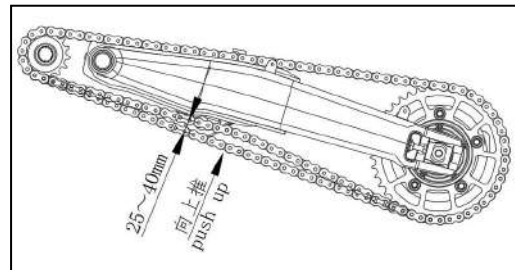

Schematic diagram of tightness

Note

When adjusting the drive chain sag, make sure the upper part of the chain must be tensioned.

Clutch

- Check the free stroke of the clutch handle.

Free travel of clutch lever: 10 - 15 mm

Check whether the clutch cable is bent or damaged. If necessary, please be replaced by locomotive repair shop. Please lubricate the clutch cable with commercially available cable oil to prevent premature wear and corrosion.

Note

Incorrect free stroke adjustment will cause premature wear of the clutch.

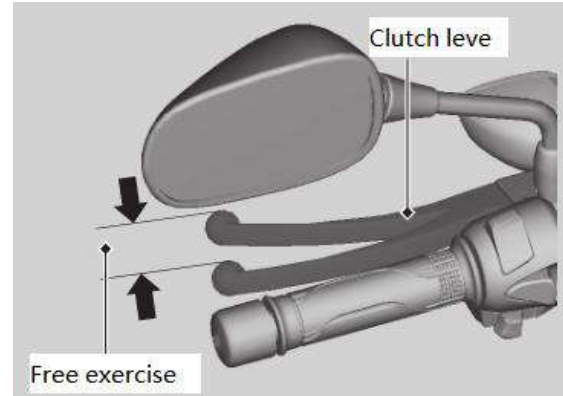

Gas pedal

Check the gas pedal

When the engine is out, check that the throttle is moving smoothly from full close to full open in all directions and that the free travel is correct. If the throttle operation is not smooth, automatically shut down or the cable is damaged, please be repaired by locomotive repair shop.

Free stroke of throttle handle flange: 2 -6 mm

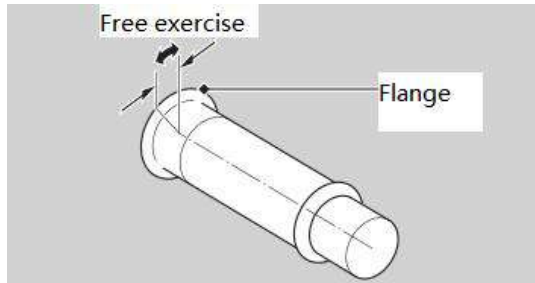

Adjusting brake handle

You can adjust the distance between the top of the brake handle and the handle.

Adjustment method

Push the brake handle inward to the desired position while turning the adjuster until the line is digitally aligned.

After adjustment, check the brake handle for proper operation before riding.

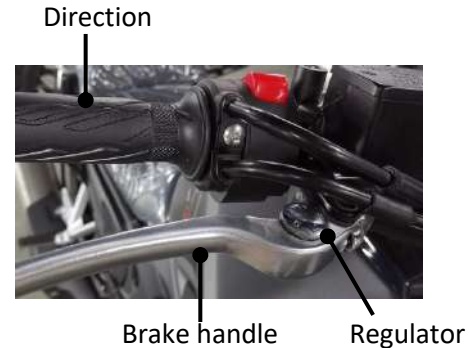

Note

Do not spin the regulator beyond its natural limit.

Headlight beam adjustment

Adjust the headlight beam

You can adjust the longitudinal Angle of the beam by moving the headlight. Use the phillips screwdriver provided in the kit if necessary.

Please comply with local laws and regulations.

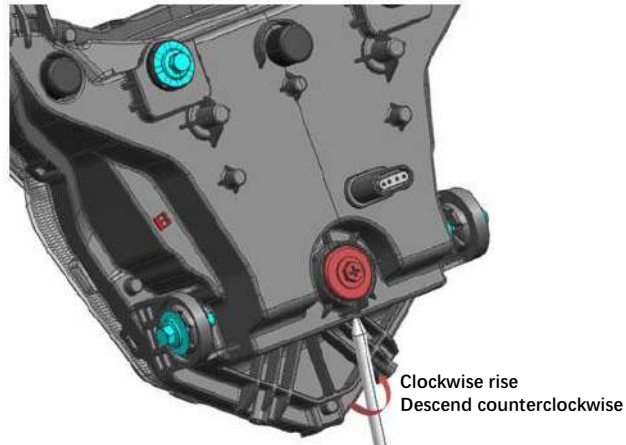

Fault handling

Please read the "Importance of Maintenance" and "Maintenance Specifications" carefully before attempting any maintenance.
Please refer to "Technical parameters" for maintenance data.

Engine cannot start (indicator light is always on)	54	Other Warning instructions.....	58
Overheating (coolant temperature indicator light on) ...	55	Fuel gauge fault indication	58
The warning light is on or flashing	56	A flat tire	59
Low oil pressure indicator light	56	Electrical fault	64
Failure indicator light of electronic injection system	56	Battery dead	64
ABS indicator light	57	Fuse blew	64

The starting motor is running, but the engine fails to start.

Check the following items:

- Check the correct engine starting sequence
- Check your oil tank for gasoline
- Check the roll sensor for abnormalities
- Check whether the electronic spray fault indicator light is on
Please feel free to contact The special maintenance store if your light lights up.
- Check whether the battery voltage is too low.

Starting motor not working

Check the following items:

- Make sure the engine starting sequence is correct
- Confirm that the engine extinguishing switch is in (running) position
- Check whether the fuse has blown
- Check whether the battery connection is loose or the battery end corrosion
- Check battery condition. If the problem still exists, Please have your motorcycle serviced or serviced by .
- Check whether the battery voltage is too low.

Overheating (coolant temperature indicator light on)

The engine overheats under the following conditions:



- The coolant high temperature indicator light is on
- Speed up slowly

In this case, the motorcycle safety pushed to the side of the road, take the following measures.

Prolonged high speed idling may cause the coolant temperature indicator light to turn on.

Note

Continuing to drive an engine too hot can seriously damage the engine.

1. Turn off the engine with the ignition switch and turn to  (on) position.
2. Check if the radiator fan is in operation, then turn the ignition switch to  (off) position.

If the fan is not running:

Do not start the engine on suspicion of failure. And then the motorcycle will be shipped to for maintenance.

If the fan is running:

Leave the ignition switch in  (off) position and wait for the engine to cool down.

3. After the engine cools, check the radiator hose for leaks.

If there's a leak:

Don't start the engine. And have your motorcycle serviced or serviced at .

4. Check the coolant level in the coolant tank.
 - ▶ Add coolant if necessary.
5. If all 1-4 checks are normal, you may continue to ride, but please pay close attention to the coolant high temperature indicator.

The warning light is on or flashing

Low oil pressure indicator light

If the low oil pressure indicator lights up, safely push to the side of the road and shut off the engine.

Note

Riding under low oil pressure can seriously damage the engine.

1. Check engine oil level and add oil if necessary.
2. Start the engine.

▶ I believe you can only continue driving after the low oil pressure indicator lights out.

Rapid acceleration may immediately cause low oil pressure lights to light up, especially if the oil is at or near the bottom limit.

If the oil level is normal and the low oil pressure indicator is on, please turn off the engine and contact Special maintenance.

If the engine oil level drops quickly, your motorcycle may leak oil or have other serious problems. Please have your motorcycle serviced or serviced by .

Failure indicator light of electronic injection system



If this indicator lights up during the ride, you may have a serious problem with your Efi system. Please slow down and submit it to for maintenance as soon as possible.

ABS indicator light

If any of the following indicates a serious problem with your ABS. Please slow down and submit it to for maintenance as soon as possible.

- The indicator light lights up or begins to blink when riding.
- The indicator light does not light when the ignition switch is in the  (on) position.
- The indicator light will not go off if the speed is higher than 5km/h.

If the ABS light is still on, your braking system will operate in normal mode, but without anti-lock.

ABS lights may flash when you move the front wheel of the motorcycle  or spin the rear wheel . In this case, the ignition switch can be turned to (off) and then to  (on) position. The ABS light will go off when your speed reaches 12km/h.

Other Warning instructions

Fuel gauge fault indication

In the event of a fuel system failure, the fuel gauge indicator light may appear as shown.

If these instructions appear, please contact as soon as possible.

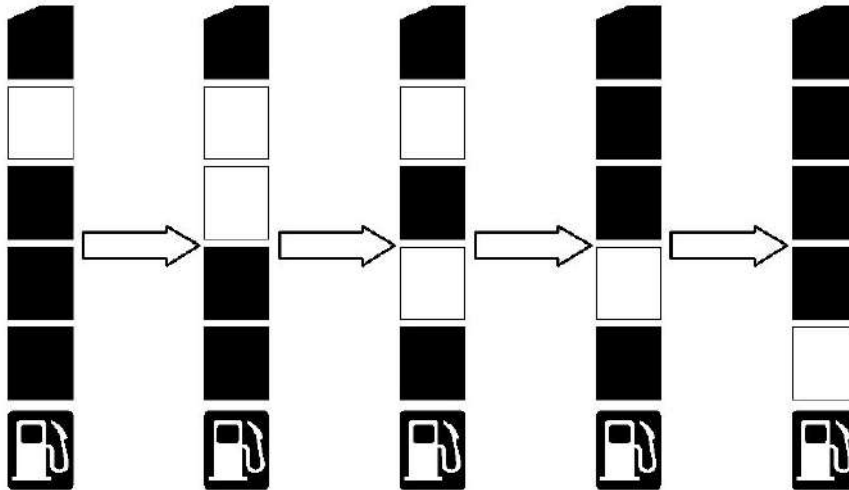

A flat tire

Repairing punctured tyres or disassembling wheels requires special tools and expertise. We suggest that this kind of maintenance be completed by .

If you have had an emergency tire repair, be sure to go to for a motorcycle check or a tire change.

Emergency repairs are performed using a tire repair kit

If your tire is slightly punctured, you can use the tubeless tire Repair kit for emergency repair and follow the instructions provided in the tire emergency repair kit.

It is dangerous to ride a motorcycle that has been patched through temporary tyres at a speed of no more than 50km/h.

As soon as possible, it will be submitted to for tire replacement.

Warning!

It is dangerous to ride a motorcycle that has been patched up with temporary tyres. If the temporary repairs fail, an accident can occur, causing serious injury or death.

If you must ride a motorcycle that has been patched with temporary tires, drive slowly and carefully. Do not exceed 50km/h until the tyre is changed.

Remove the wheel

If you need to remove the wheel to repair the puncture, follow these steps. When you remove and install the wheel, be careful not to damage the wheel speed sensor and the ABS gear ring

Front wheel disassembly

1. Firmly support the motorcycle with maintenance bracket or crane and lift the front wheel off the ground.
2. Remove front fender
3. Remove left or right brake calipers.
 - ▶ Support the brake caliper assembly and do not hang from the brake hose. Do not twist the brake hose.
 - ▶ Avoid getting lubricating oil, oil or dirt on the brake disc or disc.
 - ▶ When the brake calipers are removed, do not pull the brake handle.
 - ▶ Care should be taken to prevent brake calipers from scratching the wheel during disassembly.

4. Loosen axle lock bolts and front axle.
5. Remove the front axle and front wheel.

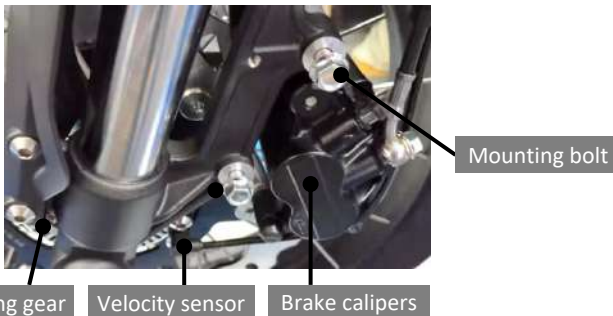
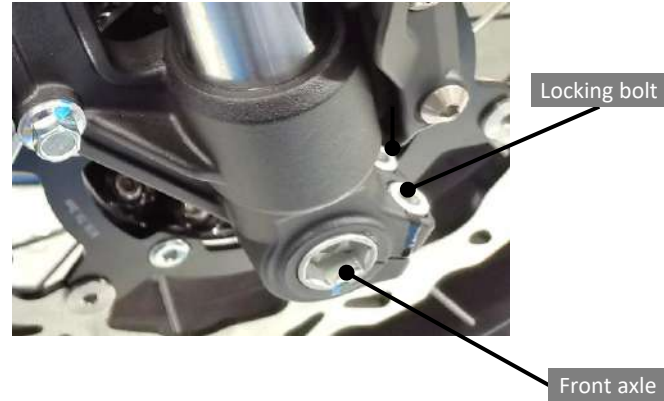

Installation

1. Put the front wheels in the middle of the front shock absorption; Front wheel bushing - place left side mounting hole of front wheel and brake disc into brake caliper
2. Pass the front axle from right to left through the front axle and tighten it into the thread of the left front shock absorption. Torque: 22n. M
3. Install brake calipers and tighten bolts.
Torque: 22 N· M
 - ▶ Care should be taken to prevent brake calipers from scratching the wheels while being installed.
 - ▶ Use new assembly bolts when installing brake calipers.
4. Install front fender (long end mounted backward). Torque: 8 N·m

Note

When the wheels or calipers are in place, carefully install the brake discs between the brake discs to prevent them from being cut.

5. Place the front wheel on the floor.
6. Operate the brake handle several times. Then shake the fork up and down several times.
7. Tighten the wheel shaft locking bolts.
Torque: 22 N· M
8. Lift the front wheel off the ground again and check if the wheel rotates smoothly after you release the brake handle.
If you do not use torque wrenches during the installation, please have them verified by .
Improper installation will result in poor braking performance.

I Rear wheel

Disassembly

1. Park the motorcycle on a firm level.
2. Firmly support your motorcycle with maintenance bracket or crane and lift the rear wheel off the ground.
3. Remove Back segment of muffler, Rear fendeBracketr, Chain Case.
4. Take out the rear wheel bushing and rear wheel axle.
5. Remove the rear wheel.

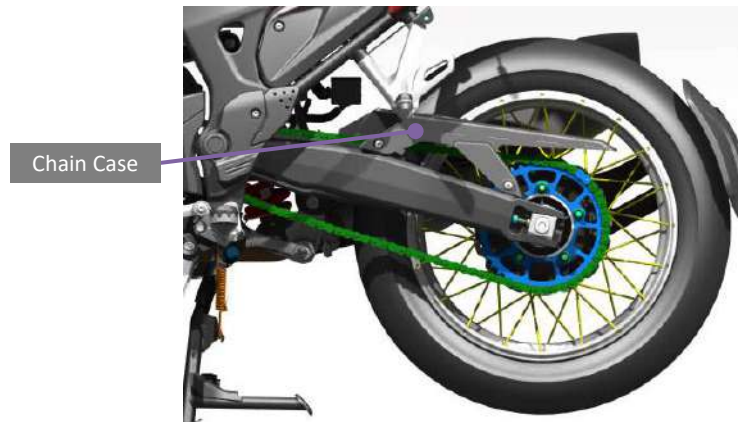
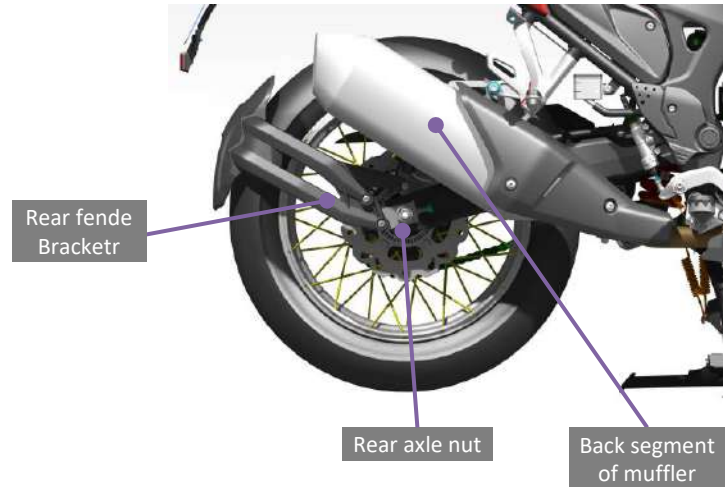

安装

1. Install the rear wheels in the reverse order of disassembly.

▶ Be careful to prevent brake calipers from scratching the wheels while installin.

2. Align the holes of the rear wheel, install the rear wheel bushing (the bushing should be greased), and then insert the rear wheel shaft into the rear wheel assembly hole from left to right.

3. Tighten the rear axle nut. Torque: 128 n. m

4. Install the Chain Case, Rear fendeBracketr, back segment of the muffler.

The wheel should turn freely.

If the torque wrench is not used during the installation, please submit it to for confirmation as soon as possible. Improper installation will result in poor braking performance.

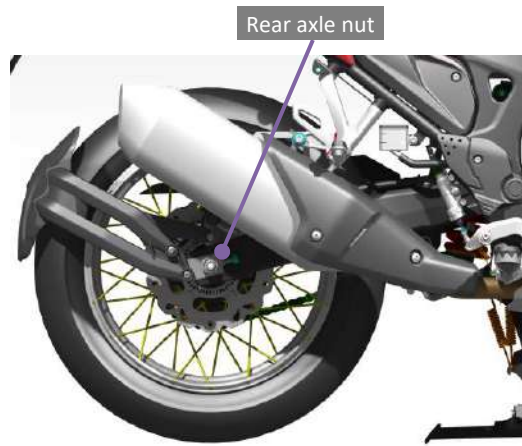

Note

When installing the wheels or calipers in place, carefully install the brake discs between the brake discs to prevent scratches.

Electrical fault

Battery dead

Use the motorcycle battery charger to charge the battery. Remove the battery from the motor before charging it. Do not charge your motorcycle with a battery charger, as this can cause the motorcycle battery to overheat and cause permanent damage.

If the battery has not been restored after charging, please contact special maintenance.

Note

It is not recommended to use an car battery because it can damage the electrical system of your motorcycle.

Fuse blew

Refer to "Check and Replace Fuses" before handling fuses

! Fuse box fuse

1. Remove seat cushion.
2. Remove the fuse box cover.
3. Pull out the fuse and check whether it fuses. If it fuses, be sure to replace it with a backup fuse of the same specification.
4. Install fuse box cover.
5. Install cushions.

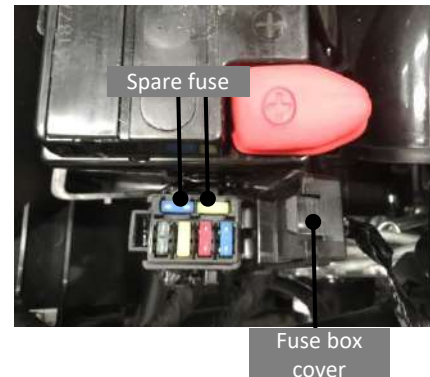

Relevant information

Key	66
Instrumentation, control and other functions	67
Motorcycle maintenance	68
Motorcycle store	71
Transportation of motorcycle	71
Environment	72
Frame number	73
Nameplate	73
Catalytic converter	74

Key

Ignition key

This motorcycle comes with two ignition keys which are used to start the engine

- Don't bend the key or stress it too much.
- Avoid prolonged sun exposure or exposure to high temperatures.
- Do not grind, punch, or change its shape in any way.

In case of loss, please take good care of at least one of your keys. Make a copy immediately if you lose one.

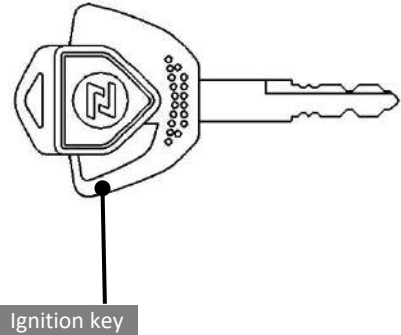

Instrumentation, controls, and other functions

Ignition switch

The ignition switch in  (on) position when the engine stops will drain the battery.
Don't turn the key when riding.

Engine kill switch

Do not use the engine kill switch except in an emergency. Doing so while driving will cause the engine to stop and make it unsafe to ride.
If you use the engine extinguishing switch to shut off the engine, be sure to turn the ignition switch to the  (off) position, otherwise, it will drain the battery.

Odometer, Meter

Odometer: When the reading exceeds 999,999,
The display will be locked at 999,999.

Meter: The count is cleared when the meter reading exceeds 9999.9.

Ignition cutoff system

If the bike falls, the tilt sensor automatically cuts off the fuel pump. The meter will display the electro-spray fault (the fault code P1098 can be read out with the diagnostic instrument). If the code needs to be cleared:
(1) Manually clear the fault code: before opening the key, the relative opening degree of the throttle is more than 50%, and maintain the opening time is more than 3s; After opening the key, starting the engine, the failure light goes out.
(2) Automatically clear the fault code: use the dedicated equipment, click to read the fault code interface, find the fault code, directly click delete, to clear the fault code.

Motorcycle maintenance

Regular cleaning and polishing ensure that the motorcycle will last a long time. Clean motorcycles are easier to spot potential faults.

In particular, anti-freezing seawater and salt sprinkled on roads can accelerate corrosion. Wash your motorcycle thoroughly after driving along the coast or on the road surface treated above.

Cleaning

Wait for the engine, muffler, brake, and other high-temperature components to cool before cleaning.

1. Flush the motorcycle thoroughly with low-pressure hose to remove loose dirt.
2. If necessary, use a sponge or towel dipped in a flexible cleaner to remove dirt from it. Wash the bike thoroughly with enough water and dry with a clean soft cloth.
4. After drying the motorcycle, lubricate the moving parts.

- ▶ Make sure no grease splashes on brakes or tires.

The braking performance of oil-contaminated brake discs, brake discs, brake drums and brake shoes will be greatly reduced and may lead to accidents.

5. After cleaning and drying the motorcycle, lubricate the drive chain immediately.
6. Waxing can prevent corrosion.

- ▶ Avoid products containing strong detergents or chemical solvents. These substances can damage the metal, paint and plastic parts of a motorcycle.

Do not wax tires and brakes.

- ▶ If you have a matte finish on your motorcycle, do not wax these matte finishes.

I Precautions for cleaning

When cleaning, follow these guidelines:

- No water cannon:
 - ▶ Water cannon can damage moving parts and electrical parts beyond repair.
 - ▶ Moisture from the intake may be drawn into the throttle body and/or into the air filter.
- Do not rinse the muffler directly with water:
 - ▶ Water intake of the muffler may cause failure to start and rust of the muffler.
- Dry brake:
 - ▶ Water can degrade braking performance. After cleaning, intermittent use of the brake at low speeds will help to dry.
- Do not rinse under the seat cushion with water:
 - ▶ Water entering the seat case may damage your documents and other items.
- Do not rinse the air filter directly with water:
 - ▶ The engine may not start if the air filter is flooded.
- Do not flush headlight directly with water:
 - ▶ The internal lens of the headlight may temporarily fog after cleaning or while riding in the rain. This does not affect the headlight function.

However, if you find that there is a large amount of water or ice accumulated in the lens, please have your motorcycle serviced or serviced at .

- Do not wax or polish matte finish:
 - ▶ Clean the matte finish with a soft cloth or sponge, plenty of water, and a mild detergent. Dry with a clean soft cloth.

Aluminum components

Aluminum can corrode when it comes in contact with dirt, mud, or road salt. Clean aluminum parts regularly and follow the following guidelines to prevent scratches:

- Do not use a hard brush, wire ball or other frictional cleaning products.
- Don't drive or scratch on the curb.

Panel

Follow the following guidelines to prevent scratches and damage:

- Wash gently with a sponge and enough water.
- Clean with diluted detergent and wash thoroughly with sufficient water to remove stubborn dirt.
- Avoid putting gasoline, brake fluid or stain remover on meters, panels or headlights.

Exhaust pipe and muffler

The exhaust pipe and muffler are stainless steel, but may also be soiled by mud or dust.

Use wet sponge to dip in the kitchen with liquid attrition agent to remove mud or dust, rinse seriously with clear water next. Dry with suede or soft towel. If necessary, burn marks can be removed with a fine, commercially available compound and then rinsed in the same way as mud and dust are removed.

If the exhaust pipe and muffler have been painted, use a neutral detergent to clean the paint surface of the exhaust pipe and muffler. If you are not sure whether the exhaust pipe and muffler have been painted, please contact Special maintenance.

Note

Even though the exhaust pipe is stainless steel, it will rust. Once found, remove all traces and dirt immediately.

Motorcycle storage

If you keep your motorcycle outdoors, you should consider using a full body shield.

If you do not ride for a long time, follow these guidelines:

- Clean motorcycle and wax all paint finishes (except matte finish). Apply rust preventing oil to all chrome plated parts.
 - Lubrication drive chain.
 - Put the motorcycle on the maintenance bracket and pad it with wooden blocks, so that both tires are off the ground at the same time.
 - After it rains, remove the body cover and let the motorcycle dry.
 - Remove the battery to prevent discharge.
- Fully charge the battery and place it in a cool and ventilated place.
- ▶ If you leave the battery in place, disconnect the negative terminal to prevent discharge.
- Inspect all items on the maintenance periodic table before reuse of stored motorcycles.

Transportation of motorcycle

If you need to transport your motorcycle, you should use a motorcycle trailer or a flatbed truck or trailer with a ramp or lifting platform, and you should use a motorcycle strap. Never attempt to drag a motorcycle with its wheels on the ground.

Note

Towing a motorcycle can seriously damage the transmission.

Environment

Owning and driving a motorcycle is a great pleasure, but you must do your duty to protect the environment.

Choose the right detergent

Use biodegradable stain remover when cleaning motorcycles.

Avoid sprays containing chlorofluorocarbons (CFCs), which can damage the atmosphere's protective ozone layer.

Waste recovery

Store oil and other toxic waste in approved containers and take to a recycling center. Call your local or national public affairs or environmental services office to find a recycling center in your area and instructions on how to dispose of non-recyclables. Do not pour used engine oil into garbage cans or drains or on the ground. Used oil, gasoline, coolant and cleaning solvents contain toxic substances that can harm cleaning workers, contaminate drinking water, lakes, rivers and the sea.

Frame and engine frame Numbers are unique, used to identify your motorcycle, and are provided when registering a motorcycle. It may also be required when ordering replacement parts. Please record these Numbers and keep them in a safe place.

Frame number

The frame number is engraved on the right side of the frame.



Frame number



Engine number

VIN plate

The VIN plate is affixed to the left side of the frame.



VIN plate

Note

In different countries, the Frame number/VIN plate may be located in opposite direction.

Catalytic converter

This motorcycle is equipped with a ternary catalytic converter. The catalytic converter contains precious metals that act as high temperature chemical reaction catalysts to convert hydrocarbons (HC), carbon monoxide (CO) and nitrogen oxides (NOx) in the exhaust gas into a regulated mixture.

Faulty catalytic converters can pollute the air and degrade your engine performance. Always use the original components when replacing them.

Follow these guidelines to protect your motorcycle's catalytic converters:

- Use only unleaded gasoline. Leaded gasoline can damage catalytic converters.
- Keep the engine in good working condition.
- If the engine does not catch fire, backfires, stalls or otherwise runs incorrectly, you must stop driving and turn off the engine and have your motorcycle serviced or serviced at .

Technical parameters EU version

Total length	2200mm	Cylinder diameter X stroke	67*66.8mm
Total width	935mm	Compression ratio	10.7:1
Total high	1400mm	Maximum net power	32.5kW/8500(r/min)
Axial spacing	1479mm	Maximum torque	40.5 N • m/6500(r/min)
Wheel spacing	/	Idle speed	1500±100(r/min)
Preparing weight	206kg	Cylinder working volume	471 mL
Payload	366Kg	Spark plug	CPR8EA (NGK)
Front tire size	110/80R19	Spark plug clearance	0.8-0.9mm
Rear tire size	150/70R17	Valve clearance	Inlet valve: 0.16± 0.03mm
Top speed	150km/h		Exhaust valve: 0.27± 0.03mm

Lubricating oil capacity	2.7L	Main fuse	30A
Gas capacity	20L	Headlight	LED Light
Primary transmission ratio	2.029	Front light	LED Light
One gear	3.285	Rear/brake light	LED Light
Two gear	2.105	Front turn signal	LED Light
Three gear	1.600	Rear turn signal	LED Light
Four gear	1.300	Neutral lamp	2V 0.01W
Five gear	1.150	After the license plate lamp	LED Light
Six gear	1.043	Steering light	LED Light
Final gear ratio	/	Instrument indicator light	2V 0.01W
Battery	12V 8.6Ah	Ignition	ECU Control ignition

Note

In different countries, certain items of technical parameters may differ as different version is applicable

Torque parameters

Fastener type	Torque	Fastener type	Torque
5mm bolts and nuts	5.2	5mm screw	4.2
6mm bolts and nuts	10	6mm screw	9
8mm bolts and nuts	22	6mm Flange bolt (8mm small flange)	10
10mm bolts and nuts	34	6mm Flange bolt (8mm big flange)	12
12mm bolts and nuts	54	6mm flange bolts (10mm) and nuts	12
		8mm flange bolts and nuts	27
		10mm flange bolts and nuts	39

Note

In addition to the specified torque, the standard torque values in the table above are adopted.

Tightening frame torque

Item	Thread diameter (mm)	Torque (N.m)	Remark
Brake pedal and brake lever bolt	M5	6n. M	
The screw connecting the throttle cable clamp and the handle base	M5	1n. M	
Screws for connecting the front upper mudguard with the left and right decorative blocks	M5	5n. M	
Screws for connecting instrument housing and headlight housing	M5	5n. M	
Screw connecting the lower guard plate of the fuel tank and the side guard plate	M5	5n. M	
Screws connecting the guard plate in the fuel tank to the left and right guard plates	M5	5n. M	
Screws of the front upper mudguard and fuel tank guard plate	M5	5n. M	
Screws for the front upper fender and the headlight housing	M5	5n. M	
Screws connecting the left and right guard plates of the fuel tank of the front upper fender	M5	5n. M	
Screws connecting the bottom plate of the tail box and the rear armrest (optional for Lobooc case)	M5	4n. M	
Screw connecting the rear small mudguard bracket to the rear wheel small mudguard	M5	4n. M	
Screw for connecting windshield and headlight bracket	M5	4n. M	
Screw for connecting the lock cover and the upper link board	M5	4n. M	
Screws connecting the left and right high voltage packages with the frame	M5	4n. M	
Screw connecting air filter and throttle valve body	M5	4n. M	
Nuts connecting the left and right high voltage packages to the frame	M5	4n. M	
Nut for connecting oil pump and oil tank	M5	6n. M	
Nut for connecting license plate lamp and rear fender	M5	2n. M	
Bolt connecting carbon canister bracket and frame	M6	12n. M	
Bolt connecting brake hose damping clip with left front damping	M6	8n. M	
Bolt connecting horn and frame	M6	12n. M	
Bolt connecting air filter bracket and frame	M6	8n. M	
Bolt connecting rear brake main pump and frame	M6	12n. M	
Bolt connecting ABS bracket and ABS	M6	8n. M	
Bolt connecting battery box and frame	M6	8n. M	

Item	Thread diameter (mm)	Torque (N. m)	Remark
Bolt connecting rear mudguard bracket and frame	M6	12n. M	
Bolt connecting seat lock and frame	M6	12n. M	
Bolt connecting front brake hose seat and frame	M6	8n. M	
Bolt connecting upper mud guard and headlight bracket	M6	8n. M	
Bolts connecting the front left and right sides of the rear mudguard to the frame	M6	6n. M	
Bolt connecting engine lower guard plate bracket and engine	M6	12n. M	
Bolt of oil sensor wire hook	M6	12n. M	
Bolt connecting fuel rail and throttle valve body	M6	12n. M	
Bolt of rear brake oil cup	M6	8n. M	
ECU assembly and the screws of the front section of the rear mudguard	M6	4n. M	
OBD assembly and the screws of the front part of the rear mudguard	M6	4n. M	
Bolt connecting water tank and frame	M6	10n. M	
Bolts connecting the left and right side guards of the fuel tank to the frame	M6	10n. M	
Bolts connecting the left and right fuel tank lower guard plates to the frame	M6	10n. M	
Gear lever bearing and gear lever bolt	M6	10n. M	
Air filter and seat cushion bracket bolt	M6	10n. M	
Bolt connecting seat cushion and frame	M6	10n. M	
Bolt connecting gear lever rocker arm and engine	M6	10n. M	
Bolt connecting brake lever and lever end adjusting bearing	M6	10n. M	
Bolt connecting headlight and headlight bracket	M6	10n. M	
Bolt connecting small engine sprocket cover and engine	M6	8n. M	
Bolt connecting the rear small mud guard bracket and the right chain adjuster	M6	10n. M	
Bolt connecting ABS and frame	M6	10n. M	
Bolt connecting rectifier and frame	M6	12n. M	
The bolt connecting the left front bracket of the engine lower guard plate and the engine	M6	12n. M	
The bolt connecting the right rear bracket of the engine lower guard and the engine	M6	12n. M	
Bolt connecting the scald cover to the engine	M6	12n. M	

Item	Thread diameter (mm)	Torque (N.m)	Remark
Bolt connecting rear small mudguard bracket and rear sensor brake caliper	M6	10n. M	
Bolt of right pedal bracket (braking spring)	M6	10n. M	
Screws for front wheel speedometer and right front brake caliper	M6	8n. M	
The bolt connecting the front brake hose to the lower link plate	M6	8n. M	
Screw connecting the rear brake hose to the flat fork	M6	8n. M	
Screw for connecting chain box hook and flat fork	M6	8n. M	
The screw connecting the right hand windshield to the handle	M6	8n. M	
The screw connecting the instrument housing and the headlight bracket	M6	8n. M	
Screws connecting the hood and the headlight bracket	M6	8n. M	
Screws connecting the left and right body to the frame	M6	8n. M	
Screws for the rear shock-absorbing small fender	M6	8n. M	
Screws connecting the left and right frame decoration blocks to the frame	M6	8n. M	
Screws connecting left and right flat fork decoration cover with frame	M6	8n. M	
Screw for connecting chain box and flat fork	M6	8n. M	
Screws connecting the bottom plate of the tail box and the rear armrest (optional for Lobo case)	M6	4n. M	
Screws connecting the rear cover to the body and frame	M6	8n. M	
Screws connecting left and right flat fork shaft decorative blocks with frame	M6	8n. M	
Screw connecting the lower guard plate of the engine and the lower guard plate bracket	M6	8n. M	
Screws connecting the front fender to the left and right front shock absorbers	M6	8n. M	
The screw connecting the muffler guard plate and the muffler	M6	8n. M	
Screw for fastening side bracket switch and side bracket bolt	M6	8n. M	
Screws connecting the guard plate and the left and right guard plates in the fuel tank	M6	6n. M	
Screw for connecting chain protection card and flat fork	M6	8n. M	
Bolt connecting the brake lever and the brake lever bracket seat	M6	8n. M	
Nut for gearshift adjusting rod (orthodontic)	M6	5n. M	
Nut for gearshift adjusting rod (reverse thread)	M6	5n. M	
Nut for connecting the tail box hook and the rear armrest (optional for Lobo case)	M6	5n. M	
Nuts connecting left and right hand windshields with handle bolts	M6	5n. M	

Item	Thread diameter (mm)	Torque (N. m)	Remark
Screw for connecting the tail box hoist and the tail box bracket (optional for Lobo case)	M6	10n. M	
Screws for connecting the tail box hoist and the left and right side box brackets (optional for Lobo case)	M6	10n. M	
Bolt connecting the kettle to the frame	M6	4n. M	
Bolts connecting the front and rear left and right sides of the rear mudguard to the frame	M6	4n. M	
Bolts connecting the left and right side box brackets and the rear guard bars of the side box brackets	M8	22n. M	
Bolts connecting the left and right bumpers, the bumper and the headlight bracket	M8	22n. M	
Bolt connecting the front mounting hole of the rear armrest with the frame	M8	30n. M	
Bolts connecting the left and right front pedals to the frame	M8	22n. M	
Bolt connecting headlight bracket and frame	M8	22n. M	
Bolt connecting the brake pedal to the frame	M8	22n. M	
Bolt connecting shift lever and frame	M8	22n. M	
Bolt connecting fuel tank and frame	M8	22n. M	
Bolts connecting the left and right front brake calipers with the left and right front shock absorbers	M8	22n. M	
Bolt connecting the muffler (front) section to the frame	M8	22n. M	
Bolt connecting muffler (rear) and right pedal	M8	22n. M	
Left and right chain adjustment bolts of army green	M8	10n. M	
The bottom barrel of the front shock absorber locks the bolts of the front axle	M8	22n. M	
Bolt connecting side box bracket and frame	M8	22n. M	
Screw connecting the lower link plate of the steering column and the front shock absorber	M8	22n. M	
Screw for connecting electric door lock and upper link board	M8	22n. M	
The screw of the upper card socket	M8	22n. M	
Screws for fastening the connecting plate and the front shock absorber in the direction	M8	22n. M	
Screws connecting the front of the left and right side box brackets with the frame	M8	22n. M	
Screw for connecting left/right rear pedal and frame	M8	22n. M	
Screws connecting the front and rear brake discs to the hub	M8	30n. M	
The double-end threaded post of the lower card seat and the lower link plate of the direction handle	M8	M10-30n. M/M8-22n. M	
Nuts for left and right chain adjustment	M8	10n. M	

Item	Thread diameter (mm)	Torque (N.m)	Remark
Nut for connecting headlight bracket and frame	M8	22n. M	
Nut for connecting the bottom plate of the tail box and the rear armrest (optional for Lobooc case)	M8	22n. M	
Nuts for left and right box brackets and rear bumper (optional for Lobooc case)	M8	22n. M	
Nuts connecting the left and right bumpers	M8	22n. M	
Orient the nut of the lower card seat and the lower link plate	M8	22n. M	
Nut connecting the rear section of the muffler and the right rear pedal	M8	22n. M	
The nut connecting the front section of the muffler to the engine	M8	22n. M	
The screw connecting the rear of the tail box bottom plate and the rear armrest (optional for Lobooc case)	M8	22n. M	
Screws connecting the front and rear armrests of the tail box bottom plate (optional for Lobooc case)	M8	22n. M	
Bolt connecting small sprocket and engine	M10	45n. M	
Bolts connected to the frame on the rear shock absorber	M10	60n. M	
Bolt connecting the rear mounting hole of the rear armrest with the frame	M10	33n. M	
Bolt connecting with the cradle under the rear shock absorber (standard configuration)	M10	60n. M	
Bolt connecting with the cradle under the rear shock absorber (high configuration)	M10	60n. M	
The bolt that connects the engine suspension to the frame	M10	60n. M	
Bolt connecting tripod and flat fork	M10	60n. M	
Bolt connecting tripod cradle and U-shaped cradle	M10	60n. M	
Bolt connecting U-shaped cradle and frame	M10	60n. M	
Bolt connecting the engine rear suspension to the frame	M10	60n. M	
The bolt connecting the left bumper to the engine	M10	60n. M	
The bolt connecting the right bumper to the engine	M10	60n. M	
Bolt connecting side bracket and frame	M10	After 2n.M, tighten the bolts and tighten the nut with a torque of 22n.M.	
Nuts connecting the rear shock absorber up and down	M10	60n. M	
Nut for connecting engine suspension and frame	M10	60n. M	
Nut for connecting side bracket to frame	M10	22n. M	
Nut for connecting U-shaped cradle to triangle cradle and frame	M10	60n. M	
Nut for connecting tripod cradle and flat fork	M10	60n. M	

Item	Thread diameter (mm)	Torque (N.m)	Remark
Bolt connecting the left front brake caliper and the brake oil pipe	M10	22n. M	
Bolt connecting front brake pump and brake oil pipe	M10	22n. M	
Bolt connecting rear brake caliper and brake oil pipe	M10	22n. M	
Bolt connecting front right brake caliper and brake oil pipe	M10	22n. M	
Bolt connecting the upper link plate and the steering column	M14	80n. M	
Nut for flat fork shaft fastening	M16	88n. M	
Nuts fastened to the rear axle	M20	128n. M	
Directional bearing adjustment nut	M25	The first stage is 40n.M, the second stage loosens the adjusting nut by two turns and tighten the nut to 10n.M, the third stage fixes the direction and does not loosen 1/4 turn	