



***CSC City Slicker  
Owner's and  
Service Manual***





## Table of Contents

A Word From Steve .....	3
Foreword .....	4
Caution and Warning Symbols .....	4
Section 1: Owner's Manual .....	5
General Motorcycle Safety Guidance .....	5
City Slicker Specifications .....	6
Inspections Before Riding .....	7
City Slicker Components .....	8
VIN and Motor Number .....	9
City Slicker Controls and Operation .....	9
City Slicker Reverse Operation .....	11
Load Limits .....	11
Instrument Cluster Indicators and Switches .....	11
Storage Compartment .....	13
Tool Kit .....	13
Battery Charging .....	13
Cleaning Your Motorcycle .....	16
Storing Your Motorcycle .....	17
Section 2: Service Manual .....	18
Maintenance Cautions and Warnings .....	18
Component Cleaning .....	18
Parts Inspection .....	18
Recommended Maintenance Intervals .....	19
Torque Values .....	19
Unpacking .....	20
Inspection .....	20
Frame and Body .....	20
Battery Removal .....	21
Body Panel Removal .....	24
Positioning the Motorcycle on a Jack .....	26
Front and Rear Wheel Removal .....	26
Front Wheel Removal .....	26
Rear Wheel Removal .....	28
Brakes .....	30
Front Brake Pad Inspection and Replacement .....	30
Front Rotor Inspection and Replacement .....	33
Rear Brake Pad Inspection and Replacement .....	33
Rear Rotor Inspection and Replacement .....	35
Flushing and Replacing the Brake Fluid .....	35
Bleeding the Brakes .....	36
Brake Troubleshooting .....	36
Front and Rear Wheel Bearing Removal .....	37
Suspension .....	37
Front Fork Seal Replacement .....	38
Rear Shock Absorber Adjustment .....	41



---

Rear Shock Absorber Replacement .....	41
Wheel and Tire Inspection and Maintenance .....	42
Wheel and Tire Troubleshooting .....	42
Replacing Tires .....	42
Drive System .....	44
Rear Wheel Alignment and Drive Belt Adjustment .....	44
Cush Drive Replacement .....	45
Motor Removal and Replacement .....	46
Belt Replacement .....	48
Electrical System .....	49
Electrical Components Location .....	49
Headlight Replacement .....	51
Instrument Cluster Removal and Replacement .....	53
Ignition Switch Removal and Replacement .....	53
Front and Rear Turn Signal/Brake Light Replacement .....	54
License Plate Light Replacement .....	57
Controller Removal and Replacement .....	58
Built In Test Equipment and Electrical System Troubleshooting .....	59
Electrical Schematic .....	61



### A Word From Steve

Thank you for purchasing this CSC City Slicker motorcycle. The City Slicker is a great motorcycle and we are very proud of it. The City Slicker is easy to maintain, it's reliable, and it's fun. You've made a wise purchase decision.

I want you to know that we value the trust and confidence you have in CSC. Our guiding principle will always be that our customers come first.

We wish you many miles of safe and enjoyable riding on your new City Slicker motorcycle. If there's anything we can do to enhance your ownership experience, please let us know.

Thank you again,

A handwritten signature in blue ink that reads 'Steve Seidner'.

Steve Seidner  
Founder and CEO  
CSC Motorcycles, LLC  
1331 W. Foothill Boulevard  
Azusa, California 91702  
909 445 0900  
[www.CSCMotorcycles.com](http://www.CSCMotorcycles.com)



## Foreword

The City Clicker Owner's and Service Manual provides information on operating and maintaining the CSC City Slicker motorcycle. It includes the motorcycle's technical specifications, and operating, maintenance, and adjustment data. This manual includes both the Owner's Manual and the Service Manual. The Owner's Manual is included in the first section of this document; the Service Manual is included in the second section of this document.

CSC Motorcycles stocks all City Slicker motorcycle parts, and we recommend that you use only parts and materials provided by us when servicing or maintaining your motorcycle.

The City Slicker Owner's and Service Manual is provided free to all who purchase a new CSC City Slicker motorcycle. This manual is provided to you with the understanding that it is CSC's intellectual, copyrighted intellectual property. You may not reproduce or publish online or in print any portion of this manual without CSC's express written permission.

Please read this Owner's Manual carefully prior to riding your new CSC Slicker for the first time. You should have a good understanding of how the vehicle operates prior to riding it.

Note that the technical data included in this manual is based on the City Slicker's technical parameters, dimensions, and other data at the time this manual was published. CSC reserves the right to amend the manual or the motorcycle at any time.

Do not discard used batteries as ordinary trash. Batteries no longer serviceable must be disposed of in accordance with local, state, and federal law.

If you have any questions, please contact CSC Motorcycles by calling us at 909 445 0900 or via email at [info@CSCMotorcycles.com](mailto:info@CSCMotorcycles.com).

## Caution and Warning Symbols

Caution and warning symbols in this manual are as follows:

The **Caution!** symbol indicates a condition that may lead to motorcycle damage.

The **Warning!** symbol indicates a condition that may lead to injury or death.



## Section 1: Owner's Manual

### General Motorcycle Safety Guidance

**Warning!** Do not attempt to ride this motorcycle on public roads if you do not have a motorcycle license.

**Warning!** Do not attempt to ride this motorcycle if you do not know how to ride a motorcycle.

**Warning!** Always wear appropriate motorcycle gear when riding your motorcycle. Never ride your motorcycle without wearing an approved helmet, a motorcycle jacket, eye protection, gloves, motorcycle pants, and boots.

**Warning!** Always remain alert while operating your motorcycle. Pay attention to traffic conditions and the road surface. Adjust your speed and following distances taking these factors into consideration.

**Warning!** Never operate your motorcycle while under the influence of drugs or alcohol, or when sleep deprived.

**Warning!** Never operate your motorcycle while talking, texting, or using a cell phone.

**Warning!** The motorcycle's motor and controller can get hot when the motorcycle is running and after turning it off. Do not touch it.

**Warning!** Always maintain appropriate tire pressure. Operating the motorcycle with low tire pressure will adversely affect the motorcycle's handling.

**Warning!** Replace worn tires promptly.

**Warning!** Do not attempt to open the storage area while operating the motorcycle.

**Warning!** Do not overload the motorcycle or load it unevenly.

**Warning!** Do not attempt to carry more than one passenger (in addition to the rider).

**Warning!** Do not attempt to attach packages to the handlebars or any other part of the motorcycle.

**Warning!** Do not attempt to perform "wheelies."

**Warning!** Do not operate the battery charger in standing water.

**Warning!** Do not plug the charger into an outlet with other than 120VAC power. Do not connect the charger to a 240VAC outlet.

**Caution!** Don't park your motorcycle facing downhill. If you do so, it may roll forward and fall down.

**Caution!** Always put on appropriate motorcycle gear (helmet, jacket, gloves, etc.) before getting on



your motorcycle. If you attempt to put on your motorcycle gear while straddling the motorcycle, you may drop the motorcycle.

**Caution!** Do not spray pressurized water onto the battery or into the battery compartment.

**Caution!** Charge the battery to a fully-charged state at least monthly to maximize battery life.

### City Slicker Specifications

<b>Physical Dimensions</b>	
Overall	71.0 in x 30.0 in x 41.0 in
Wheel Base	49.2 in
Turning Radius	13.1 feet
Seat Height	30.0 in
Ground Clearance	7.1 in
Rider Foot Peg Height	9.0 in
Passenger Foot Peg Height	18.0 in
Handlebar Height	39.0 in
<b>Weights</b>	
Weight	216 lbs
Maximum Carrying Capacity	330 lbs
<b>Suspension</b>	
Front Suspension	Inverted Telescopic Fork
Rear Suspension	Preload Adjustable Monoshock
Suspension Travel, Front	4.3 in
Suspension Travel, Rear	4.7 in
<b>Wheels and Tires</b>	
Front Wheel and Tire	2.75 x 12 in, 110/70 Tire, 32 psi
Rear Wheel and Tire	3.50 x 12 in, 120/70 Tire, 32 psi
<b>Brakes</b>	
Front	Twin-Piston Hydraulic Disk, 8.5 in Rotor Dia
Rear	Single-Piston Hydraulic Disk, 7.5 in Rotor Dia
<b>Power Plant</b>	
Motor	3.2KW Peak Power, 1.5KW Rated Power, Swingarm-Mounted, Brushless
Battery	Li, 72V30AH
Charging Time	6-8 hours
Charging Input Voltage	120VAC
Battery Replacement	Key Lock, Replacement Time < 1 minute
Final Drive	Toothed Belt
<b>Controls</b>	
Instrumentation	Speedometer, Odometer, Tripmeter, Temperature, Battery Status, Park Indicator, Reverse Indicator, Battery Warning, High Beam, Turn Signals, Mode Indicator
Left Handlebar	Turn Signal Switch, Hi/Lo Beam, Hi Beam Flash, Horn, Rear Brake Lever
Right Handlebar	Throttle, Lights, Mode Selector, Park On/Off, Front Brake Lever



Dash Cluster	Reverse Selector, Trip Meter Reset, K/M Selector
<b>Security</b>	
Seat	Key Lockable
Luggage Compartment	Key Lockable
Battery	Key Lockable
Forks	Key Lockable
Ignition	Key Lockable
<b>Performance</b>	
Top Speed	46.6 mph
Range	37 miles at 37 mph; 62 miles at 20 mph
<b>Storage</b>	
Storage Compartment	16.0 in x 8.5 in x 8.5 in
<b>Other Information</b>	
Colors	Red and White, Blue and White
Warranty	12 Months, Unlimited Mileage
Financing	Available
<b>Other Features</b>	
USB Charging Port	Regenerative Braking
LED Turn Signals	Reverse Drive
Onboard Diagnostics Dash Display with Diagnostic Codes	

### Inspections Before Riding

Before riding your motorcycle, you should check the following:

- Both tires are appropriately inflated.
- Neither tire has nails nor other foreign objects embedded in the tread or the sidewall.
- The battery is adequately charged for the distances you intend to cover.
- The turn signals, the front and rear brake lights, the horn, and the headlight all operate when commanded to do so (the ignition switch must be in the ON position).
- The front and rear brake levers have adequate free play.
- The front and rear brakes operate.
- The forks turn freely from side to side.
- The rear-view mirrors are adjusted appropriately.
- The drive belt is appropriately adjusted.
- Major threaded fasteners are tight. Always hand check the axle nuts, the mirror lock nuts, the steering stem nut, and the front and rear caliper bolts.



## City Slicker Components

Major components are shown in the photos below.

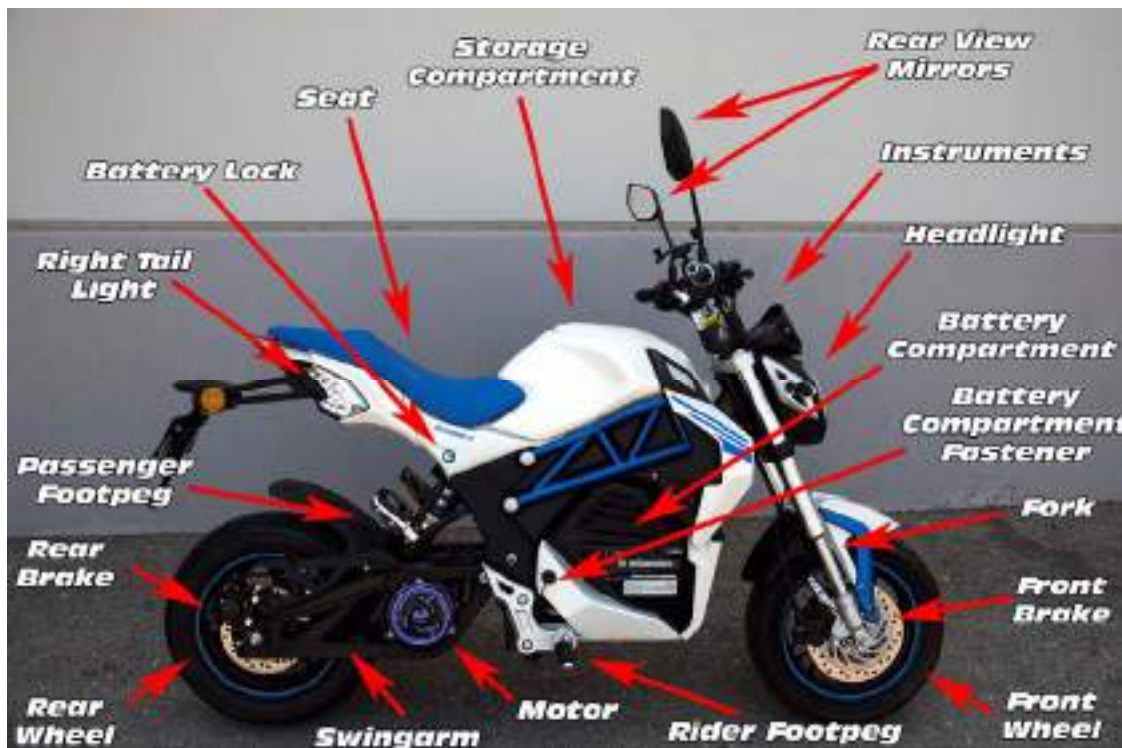

## VIN and Motor Number

The VIN is on the motorcycle frame's steering stem, and the motor number is on the motor, as shown in the photos below.



## City Slicker Controls and Operation

The City Slicker is controlled in a manner similar to a conventional motorcycle, with the following exceptions:

- There is no transmission, no gear shifting is required, and there is no gear shift lever.
- There is no clutch, so there is no clutch lever.
- The rear brake is operated by the left handlebar lever, so there is no rear brake foot pedal.

The front and rear brake levers, and the throttle, are shown in the photo below.



Handlebar switchgear is shown in the photos below.



To operate the motorcycle:

- Insert the key in the ignition lock and turn it two clicks to the right to the run position.
- Observe the battery charge indicator in the instrument cluster, and make sure adequate charge exists for the distance you plan to ride.
- Press the right handlebar switch to deactivate the P feature.
- Lift the motorcycle off the sidestand and, with your left foot, retract the sidestand. Note that the motorcycle has a sidestand disconnect feature, and it will not operate if the sidestand is in the extended position.
- Check your surroundings to make sure it is safe to enter the street.
- Twist the throttle to move forward.
- When you desire to stop or slow, apply the front and rear brake gradually by operating the left-hand lever for the rear brake, and the right-hand lever for the front brake.



**Warning!** The P feature is not a parking brake, and it does not apply the motorcycle brake. The P feature simply disengages the throttle so that turning the throttle will not apply power to the rear wheel. The intent is to prevent inadvertent motorcycle drive power from moving the motorcycle if the throttle is inadvertently turned.

**Warning!** Do not rely on the P feature to prevent the motorcycle from rolling forward when the motorcycle is parked. Never park the motorcycle facing downhill, or it may roll forward off the sidestand and tip over.

**Warning!** Do not apply excessive braking force via the brake levers. You may induce a skid and lose control of the motorcycle.

**Warning!** Observe road conditions at all times and adjust your speed and brake application accordingly.

The motorcycle is more likely to skid when roads are wet, or when sand or gravel is present.

### City Slicker Reverse Operation

The City Slicker motorcycle includes a reverse drive feature to assist in backing the motorcycle out of difficult spots. After readying the motorcycle for travel, press the R rubber-covered switch on the right side of the instrument cluster. When you do so, the R light will illuminate, indicating the motorcycle is in a reverse drive mode. Press the P switch on the right handlebar to engage the throttle. When you twist the throttle, the motorcycle will be driven in reverse.



**Warning!** Do not attempt to ride the motorcycle in reverse. This feature is only included as a backup assist.

### Load Limits

The City Slicker motorcycle weighs 216 lbs. The maximum load carrying capacity is 330 lbs.

**Warning!** Do not overload or unevenly load the motorcycle or the handling will be adversely affected.

### Instrument Cluster Indicators and Switches

City Slicker instruments and switches are summarized below.

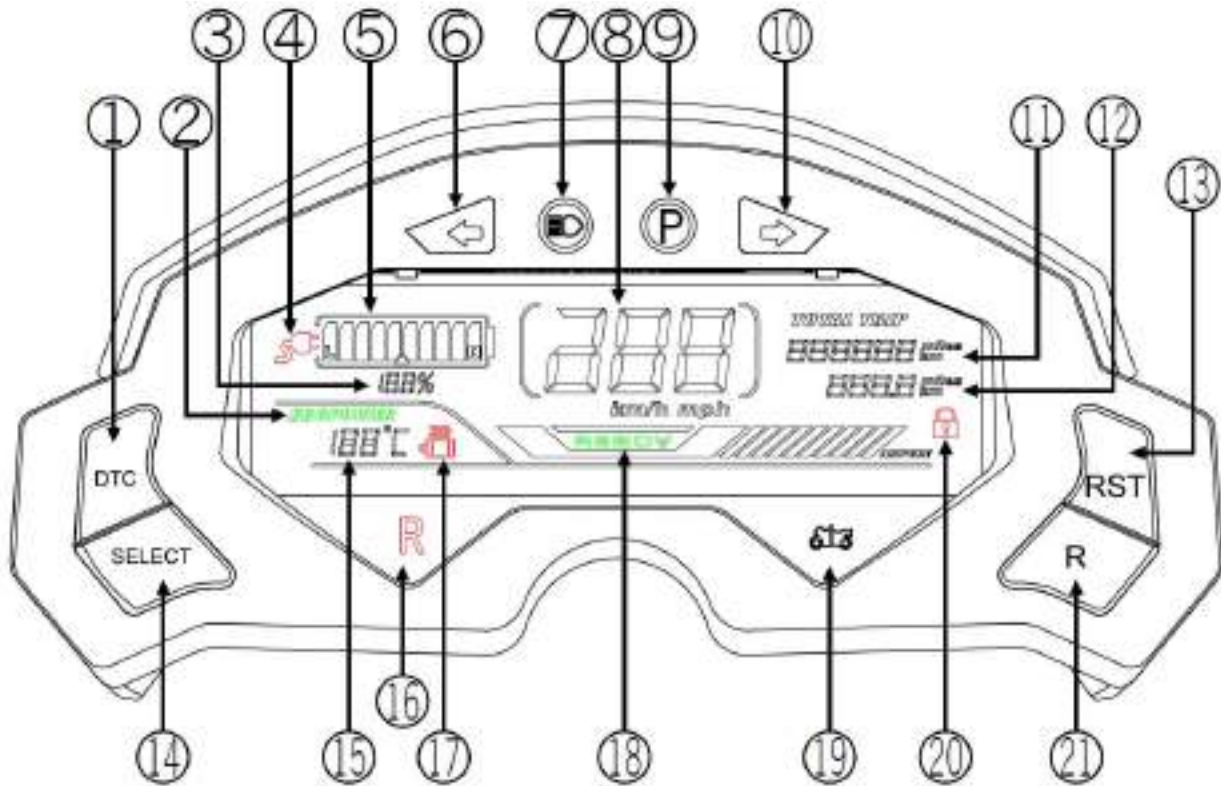

No.	Item	Description
1	Trouble inquiry.	When a fault exists, the trouble code is found by depressing this button, with the trouble code list provided in the maintenance section of this manual.
2	Display of gear.	Displays the mode in which the motorcycle is running.
3	Battery percentage.	Displays battery charge percentage.
4	Charging status.	Indicates low charge when flickering (30% or less). Also flickers during regenerative braking. Stays illuminated when charging.
5	Battery status.	Displays battery status.
6	Left turn signal indicator.	Indicates left blinker on.
7	High beam indicator.	Indicates high beam on.
8	Speedometer.	Displays speed.
9	P indicator.	Displays motorcycle is in P mode.
10	Right turn signal indicator.	Indicates right blinker on.
11	Odometer	Shows motorcycle cumulative mileage.
12	Tripmeter.	Shows motorcycle trip mileage (resets to zero when ignition turned off).
13	Instrument reset switch.	Depress and hold key to enable self-testing of instrument system.
14	English/metric system switch.	Switches between English and metric units.
15	Controller temperature.	Displays controller temperature.

No.	Item	Description
16	Reverse indicator.	Illuminates when reverse drive activated.
17	Controller overheating alert.	Illuminates if controller overheats.
18	Readiness lamp.	Illuminates when no fault present.
19	Trouble alert.	Illuminates when fault present.
20	Controller lock.	Not used on US configuration.
21	Reverse switch.	Switches motorcycle to reverse drive.

### Storage Compartment

The City Slicker has a key-lockable storage compartment about the battery (where a motorcycle gas tank would normally be located).

Inside the storage compartment is an outlet for a USB connection that can be used for charging a smart phone.

The storage compartment locks with the motorcycle's ignition key.



### Tool Kit

The City Slicker includes a tool kit that is stored in the luggage compartment. These tools should be used for emergency repairs only. CSC recommends purchasing professional tools for maintenance actions your motorcycle.



### Battery Charging

The City Slicker motorcycle is provided with an external battery charger. Charger use and operation is explained below.

You do not need to remove the battery from the motorcycle to charge it.

You do not need to open the battery access door when charging the motorcycle.

**Warning!** Do not operate the charger in standing water or in a wet area.

**Warning!** Do not touch the charger while it is operating.

**Warning!** Do not plug the charger into an outlet with other than 120VAC power. Do not connect the charger to a 240VAC outlet.

**Warning!** Do not obstruct air flow around the charger. The charger includes a cooling fan and air needs to flow freely through the charger.

**Warning!** Never leave the battery unattended while charging.

**Warning!** Do not operate the charger near any ignition sources or open flames.

**Caution!** The capacitor should be used at least 10 minutes every 2 months to keep the charger's internal capacitor operational.

**Caution!** You should charge the motorcycle battery to a fully-charged condition at least monthly when the motorcycle is storage.

**Caution!** Wait at least 30 seconds after connecting the charger to AC power before turning the capacitor on. It needs this time to adjust to the input AC voltage.

Open the charging port located above the access door of the motorcycle's battery compartment.



Make sure the charger is switched to the off position using the switch below the charger's AC input line.



Connect the mating end of the charger's electrical cord to the motorcycle charging port.



Connect the input end of the charger's cord to a standard 120 VAC power outlet.

**Caution!** Wait at least 30 seconds after connecting the charger to AC power before turning the capacitor on. It needs this time to adjust to the input AC voltage.



After waiting 30 seconds, turn the charger on with the switch on the back of the charger.



You should see the instrument panel illuminate to show the charging status. The red plug indicates charging is underway.



Leaver the charger on until the battery is 100% charged. Typically, this will take approximately 8 hours. While the battery is charging, the red LED on the charger will be illuminated. When the battery fully charged, the green LED will illuminate.





After the motorcycle instrument panels indicate the battery is 100% charged, the charger will shut off automatically after another 1 to 2 hours.



Switch the charger to the off position.



Unplug the charger from the battery charging port and then unplug the charger from the wall outlet. CSC stocks replacement chargers. If you need a replacement battery, please contact CSC at 909 445 0900.

### Cleaning Your Motorcycle

Clean your motorcycle with a clean cotton cloth or towel.

Apply wax to the painted parts after cleaning.

Apply a rust inhibitor or wax to the chrome plated surfaces.

**Caution!** Do not subject the motorcycle to a high pressure washing system. Do not spray water onto the electrical components inside the motorcycle.

**Warning!** When riding the motorcycle after cleaning it, actuate the brakes to make sure they have not been degraded as a result of cleaning the motorcycle.



CSC stocks numerous cleaning and lubrication products; please call us at 909 445 0900 to order these items.



## Storing Your Motorcycle

Clean the motorcycle before storing it.

Fully charge the battery and then remove it in accordance with the battery charging and battery removal sections of this manual.

Store the battery in a cool, dry, indoor area.

While in storage, fully charge the battery every month in accordance with the battery charging instructions in this manual.

Inflate the tires to 32 psi.

Lift the motorcycle such that the tires are off the ground.  
Store the motorcycle in a cool, dry area.

When removing the motorcycle from storage, fully charge and install the battery.

Inspect the motorcycle in accordance with the instructions in this manual.

Remove the seat following the procedure in this manual and turn the air switch (identified in the electrical segment of this manual) to the off position. This will slow the battery's normal discharge process when the motorcycle is not being used.



## Section 2: Service Manual

### Maintenance Cautions and Warnings

When you maintain or repair the motorcycle, please use original components and parts, accessories, lubricating oil and other materials that are made or recognized by CSC Motorcycles.

**Caution!** If you use any parts or components other than those recommended by CSC, it may adversely affect the performance, reliability, stability, or warranty of your motorcycle.

When working on your motorcycle, you should follow this guidance:

- **Warning!** Whenever the motorcycle is to be reassembled after disassembly, washers, seals, and cotter pins need to be replaced.
- When you fasten a series of bolts or nuts, you should do so in a diagonal pattern.
- **Warning!** Do not use flammable cleaning fluid to clean components and parts.
- **Warning!** After assembly, make sure all parts are properly assembled and tightened.
- **Warning!** Disconnect the negative battery terminal when performing any maintenance on the motorcycle.
- **Caution!** Before assembly operations, add lubricating oil or lubricating grease to lubricated surfaces.

### Component Cleaning

After parts are disassembled, they may need to be cleaned. Cleaning methods vary according to the characteristics of the parts.

- To remove oil or grease contamination, CSC recommends using Simple Green or other similar degreasing agents.
- **Warning!** Never use gasoline as a cleaning agent.

### Parts Inspection

Parts should be inspected after they are cleaned. The purpose of inspection is to check if the parts need to be repaired or replaced.



### Recommended Maintenance Intervals

Recommended City Slicker preventive maintenance is summarized below.

Item	Maintenance Interval			
	300 Miles	2000 Miles	4000 Miles	6000 Miles
Controller		Check	Check	Check
Air switch		Check	Check	Check
Braking Lever	Check and Adjust	Check and Adjust	Check and Adjust	Check and Adjust
Battery	Charge as necessary, but charge at least monthly			
Brake shoe	Check and Adjust	Check and Adjust	Check and Adjust	Replace
Brake	Adjustment	Check	Adjustment	Adjustment
Brake Fluid	Replace every 2 years			
Turn Signals and Running Lights	Check	Check	Check	Check
Headlight and Taillight	Check	Check	Check	Check
Shock Absorber	Check/Lubricate	Check/Lubricate	Check/Lubricate	Check/Lubricate
Fasteners	Check	Check	Check	Check
Tires	Check	Check	Check	Check
Tire Pressure	Check	Check	Check	Check
Steering Bearing	Check	Check	Check	Check
Drive belt	Check tension every 500 miles, replace every 20,000 miles			
Wheel Bearings	Check	Check	Check	Check
Brake Fluid	Check every 500 miles, replace every 2 years			
Threaded Fasteners	Check	Check	Check	Check
Motor	Check	Check	Check	Check

### Torque Values

A table for general torque values follows. In various places in this Service Manual, specific torque values may be provided, and you should use those where specified. In all other instances, use the values provided below. The values provided throughout are for clean, dry threads.

Bolt Size (mm)	Torque (ft-lbs)	Bolt Size (mm)	Torque (ft-lbs)
6	3-5	14	60
8	8-12	16	60-94
10	15-22	18	60-130
12	39	20	166-188



## Unpacking

When the motorcycle is delivered, check the condition of the delivered crate. If there are any anomalies, stop and call CSC at 909 445 0900. Check the VIN numbers on the exterior of the crate. Compare these numbers to the documentation delivered to you prior to the motorcycle's arrival. If the numbers don't match, stop and call CSC at 909 445 0900.

## Inspection

Perform the following inspections when servicing the motorcycle.

- Check to confirm all fasteners are properly tightened and all components are installed correctly and in an operational state.
- Swing the handlebars from side to side to make sure motion is uninhibited.
- Check belt tension and rear wheel alignment in accordance with the requirements of this manual.
- Insert the ignition key and turn it on.
- Check horn function, turn signals, headlight high and low beam, brake lights for front and rear brake activation, and instrument panel readout.
- Check tire pressure.
- Check brake and suspension function.
- Test ride motorcycle to confirm operability.

## Frame and Body

The frame and body subsystem include the motorcycle's frame, the seat, the body panels, the sidestand, the footpeg, the tool kit, and the fenders.

The tool kit is stored in the motorcycle's storage compartment.

The seat is held in place by the seat lock. The rear seat can be removed to provide access to some of the motorcycle's electrical components.

Frame and body maintenance and troubleshooting guidelines are summarized below.

Item	Cause	Symptom	Vehicle Effect	Maintenance Action
Frame	Frame is hit or falls over	Frame is curved or deformed	Drift	Correct or replace the frame
	Frame is hit or falls over	Frame is cracked or fractured	Motorcycle cannot drive	Weld or replace the frame
	Frame is impacted and shocked by road	Frame welding detachment	Shake or drift	Weld the frame
Sidestand	Deformation or fracture	Sidestand cannot return	Noise and compromised parking	Correct or replace the side support



Item	Cause	Symptom	Vehicle Effect	Maintenance Action
Left or right rear panel	Impact	Panel damaged	Compromised appearance	Replace or repair the panel
Left or right tank panel	Impact	Panel damaged	Compromised appearance	Replace or repair the panel
Front fender	Impact	Deformation or breakage	Compromised appearance	Replace the front fender
Rear fender	Impact	Deformation or breakage	Compromised appearance	Replace the rear fender
Seat cushion	Impact	Seat cushion damaged	Riding comfort decreases	Replace the seat
Front footpeg	Impact	Deformation or breakage	Compromised driving safety	Replace the footpeg
Rear footpeg	Impact	Deformation or breakage	Compromised driving safety	Replace the footpeg
Rearview mirror	Impact	Deformation or breakage	Compromised driving safety	Replace the rearview mirror

### Battery Removal

The City Slicker is key locked into the motorcycle. It can be removed for external charging or replacement. Note that the battery does not have to be removed; it can be charged while it is in the motorcycle as described elsewhere in this manual.

**Warning!** Do not attempt to disassemble the battery once it is removed.

**Warning!** Do not short circuit the battery across its terminals.

**Warning!** Do not store the battery on its sides or upside down.

**Warning!** Do not subject the battery to excess heat.

**Warning!** Only dispose of the battery at an approved disposal facility.

**Warning!** After battery removal, store it in a dry place.

**Warning!** Before attempting to remove the battery, turn off the motorcycle ignition and remove the ignition key from the ignition lock. Do not attempt to disconnect or remove the battery with the ignition on.

The procedure for battery removal is outlined below.

Place the motorcycle on its sidestand. Unscrew the battery compartment retention knob.



Remove the battery compartment door retention knob. Note that it is tethered to the motorcycle.



Swing the battery compartment door outward.



Remove the two small Phillips head screws securing the right (forward) half of the main power connector.



Disconnect the right (forward) half of the main power connector.



Unscrew the smaller connector plug above the main power connector.



Insert the ignition key into the battery lock located in the body panel below the seat on the right side of the motorcycle. While turning the key, jiggle the battery to open the lock. Do not force the key if it will not turn. Keep jiggling the battery until the lock releases the battery.



The battery lock is connector by a sheathed cable to the battery lock located under the battery tray, as shown here.



There is a bracket that goes over the top of the battery to secure it. Remove this bracket.



Lift the battery and pull it to the right just enough to allow grabbing the handle on top of the battery.

Holding both the right sight and upper battery handles, slide the battery out of the motorcycle.



**Warning!** The battery weighs 35 lbs. Make sure you have a firm grasp on it when removing it from the motorcycle. Do not drop the battery.



CSC stocks replacement batteries. If you need a replacement battery, please contact CSC at 909 445 0900.

## Body Panel Removal

Performing maintenance City Slicker maintenance involving wheel, fork, or other major component removal requires positioning the motorcycle on motorcycle jack or other suitable support. This will require removal of the body panels around the battery compartment.

**Warning!** Do not attempt to support the motorcycle on a jack or other stand without removing the plastic body work as shown here. Doing so may cause the motorcycle to slide off the support, and it will fall, possibly injuring you or others around the motorcycle. Attempting to support the motorcycle on a stand or other jack without removing the body work might damage the motorcycle or the plastic body work.

Place the motorcycle on its sidestand. Unscrew the battery compartment retention knob.



Remove the Allen bolts underneath the battery compartment.



Remove the Allen bolts at the front of the battery compartment forward section.



Remove the Allen bolts on the left side of the motorcycle bodywork.

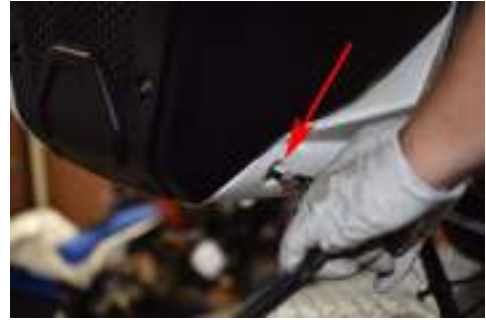

Remove the Allen bolt beneath the trellis bodywork.



Remove the Allen bolts at the top of the forward bodywork.



Remove the Allen bolt from the left black body panel.



Lift the left black body panel and remove the Allen bolt attaching the white left body panel to the motorcycle frame.



Remove the left side panels from the motorcycle.



Remove the forward and right body panels from the motorcycle frame.



### **Positioning the Motorcycle on a Jack**

With the body panels removed, you can now mount the motorcycle on a jack or other suitable, stable support.

Place the jack beneath the motorcycle. Note that the underside of the motorcycle frame has attach lugs for the body panel. Put a piece of wood or other suitable support between the frame and the jack (or other support) such that the frame does not rest directly on the body work attach lugs.



### **Front and Rear Wheel Removal**

Maintenance procedures for front and rear wheel removal are provided below.

#### **Front Wheel Removal**

In order to remove the motorcycle's front wheel, you must first place the motorcycle on a jack or other suitable support (see the Body Panel Removal and Positioning the Motorcycle on a Jack portions of this manual), and you must remove the front brake caliper (see the Front Brake Pad Inspection and Removal portion of this manual).

Remove the front axle nut from the right side of the front forks.



Loosen (but do not remove) the front axle pinch bolt on the left fork.



Using a screwdriver, push the axle from the right side of the motorcycle to the left.



Withdraw the front axle from the left side of the motorcycle.



Note the location of the steel bushing between the right front fork and the wheel hub.



Note the location of the bushing between the left front fork and the wheel hub.



The left bushing has a slot at the top, which must engage the tab on the left fork lower casting.



Note the alignment of the left front fork lower casting hub and the hub slot. These two must be aligned for reassembly.



At this point, the front wheel can be removed from the motorcycle.

Assembly is the reverse of disassembly. Install a new front disk, using blue Loctite.

### Rear Wheel Removal

**Caution!** Make sure the motorcycle is on a stable support when performing this operation.

Lift the rear wheel off the ground with a motorcycle jack or other suitable support. It is not necessary to remove any body panels if the motorcycle jack is positioned directly beneath the motor as shown here.



Detach the rear caliper from the swingarm by removing the two bolts shown in the photo.



Remove the rear axle nut.



Tap the rear axle to the left.



Remove the bushing between the rear wheel and the right side of the swingarm.



Remove the rear axle by pulling it out from the left.



Push the wheel forward and take the belt off the rear wheel pulley.



Slide the rear wheel to the rear and remove the bushing from the rear wheel pulley.



Slide the rear out of the swingarm.



Assembly is the reverse of disassembly. Align the rear wheel in accordance with the belt adjustment and rear wheel alignment procedure shown in this manual.

## Brakes

Maintenance procedures for the front and rear brakes are provided below.

### Front Brake Pad Inspection and Replacement

It is possible to inspect brake pad wear without removing the caliper or the brake pad from the motorcycle. Doing so involves viewing the pads from the front of the caliper to inspect groove depth, as shown in the photo below:

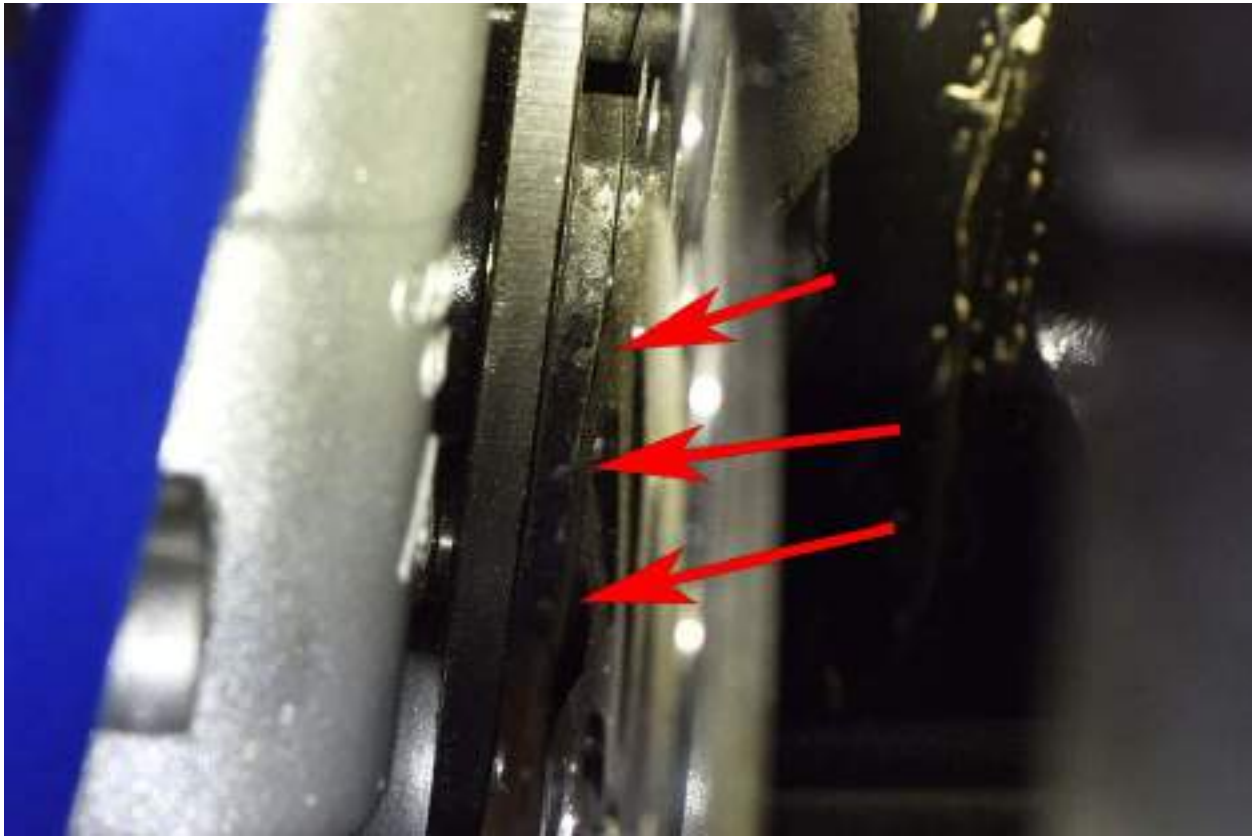

If the pad is worn such that the groove is no longer visible, replace both the inner and the outer brake pad. It is possible to remove the brake pads without removing the caliper, but the job is a lot easier if the caliper is removed. Both methods are described below.

The front brake caliper is located on the left side of the motorcycle.



Loosen both brake pins.





Withdraw both brake pins. At this point, the brake pads can be "tickled" to pop out of caliper.

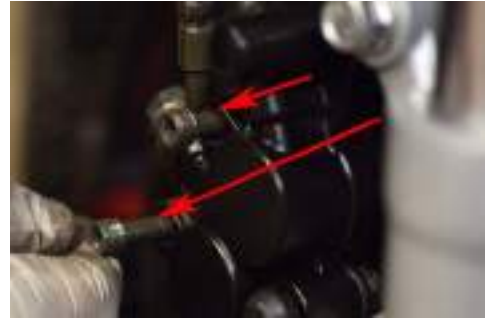

Inspect the brake pads. If the wear groove is gone or nearly gone, replace both the inner and outer brake pads.



If you experience difficulty removing the brake pads from the caliper, remove the caliper by unscrewing the two caliper mounting bolts.



Take the caliper off the fork, taking care not to scratch the front wheel.



Note that the caliper has a spring-loaded clip. The clip is orientation sensitive. The tab denoted by the arrow must be on the caliper's piston side.



The brake uses the same part number pads for both the inner and outer applications.

**Warning!** Test the brakes after installing the new pads and before venturing into traffic.



As noted above, the brake pads have a wear groove machined into the pad surface. When either pad is worn such that the wear groove is no longer visible, replace both pads with new pads. CSC stocks these pads, so call us at 909 445 0900 if you need to order a pair.

Assembly is the reverse of disassembly. Install new front pads, place the caliper over the rotor, and install the two caliper mounting bolts.

### Front Rotor Inspection and Replacement

The front brake disk is a wear item. It must be removed and replaced when the rotor thickness falls below 3mm. The disk can be inspected with the front wheel on the motorcycle. The front wheel must be removed in accordance with the procedure outlined in this manual to replace the rotor.

After removing the front wheel, gently heat the Allen bolts securing the rotor to the wheel hub. Unscrew the bolts to allow rotor removal.



CSC stocks brake rotor disks, so call us at 909 445 0900 if you need to order new disks.

Assembly is the reverse of disassembly. Install a new front disk, using blue Loctite.

### Rear Brake Pad Inspection and Replacement

You can replace the rear brake pads with the motorcycle on its sidestand. You do not need to remove the rear wheel or put the motorcycle on a jack to replace the rear brake pads.

You can see the brake pads with the caliper on the motorcycle by position yourself beneath and to the rear of the caliper. It is easier to see the brake pads by removing the caliper.

Remove the two bolts securing the caliper to the swingarm.



Inspect the brake pads to determine if they require replacement. If less than 1/16-inch of pad material remains on either pad, replace both pads.



Pop the plastic caliper off the top of the rear caliper (it has already been removed in this photo). Pull the retention clip (denoted by the arrow on the right) and pull the silver pin out of the caliper. This will allow the caliper spring clip (denoted by the arrow on the left) to be removed and the pads can be removed.



The brake pads are the same on either side of the caliper. Replace them as a set.

**Warning!** Test the brakes after installing the new pads and before venturing into traffic.



Assembly is the reverse of disassembly. Install the new pads, pump the rear brake several times, and test the brakes before venturing onto the street.

If you need a new set of brake pads, please call CSC at 909 445 0900.

## Rear Rotor Inspection and Replacement

The rear brake disk is a wear item. It must be removed and replaced when the rotor thickness falls below 3mm. The disk can be inspected with the rear wheel on the motorcycle. The rear wheel must be removed in accordance with the procedure outlined in this manual to replace the rotor.

After removing the rear wheel, gently heat the Allen bolts securing the rotor to the wheel hub. Unscrew the bolts to allow rotor removal.



CSC stocks brake rotor disks, so call us at 909 445 0900 if you need to order new disks.

Assembly is the reverse of disassembly. Install a new rear disk, using blue Loctite.

## Flushing and Replacing the Brake Fluid

It is a good idea to bleed the brakes every year, and to flush and replace the brake fluid every two years. Use only DOT4 brake fluid. We sell brake fluid suitable for use in your City Slicker motorcycle; if you need brake fluid please call us at 909 445 0900. **Caution!** Brake fluid can damage painted components. Promptly wipe up spilled brake fluid.



To drain the system, open the master cylinder located near the front and rear brake on the handlebars. Attach a hose to the caliper bleed port and route it to a suitable container. Open the caliper bleed port and allow the brake fluid to drain. Note that the drain hose is not shown in the photo to allow clarity in identifying the caliper bleed port.



After draining the brake fluid, add fluid to the master cylinder and bleed the brakes as described below.



## Bleeding the Brakes

**Caution!** Brake fluid can damage painted components. Promptly wipe up spilled brake fluid.

To bleed the brakes, attach a hose to the brake caliper bleed port and route it to a suitable container. Open the master cylinder, taking care not to spill any brake fluid.

Open the caliper bleed port while applying the brake lever, and before releasing the brake lever, close the bleed port. It's important not to allow the bleed port to remain open while releasing the brake lever or you will suck air into the system. Repeat this open-the-bleed-port, apply-the-brake-lever, close-the-bleed-port, add-brake-fluid process until the master cylinder is full. Reinstall the brake master cylinder cover.

Prior to taking the motorcycle on the street, operate it slowly and apply the brakes several times to assure proper function.

## Brake Troubleshooting

Brake troubleshooting procedures are summarized below.

Item	Symptom	Cause	Vehicle Effect	Maintenance Action
Brake pads	Reduced braking force	Worn brake pads	Longer stopping distance, weaker stopping	Replace brake pads
Air in brake line	Reduced front or rear braking force	Air intrusion into brake line	Longer stopping distance	Bleed brake system
Pulsating brakes	Pulsating brake lever	Warped rotor disk	Pulsations; longer stopping distance	Measure disk runout, replace disk rotor

## Front and Rear Wheel Bearing Removal

In order to remove the motorcycle's wheel bearings, you must first place the motorcycle on a jack or other suitable support (see the **Body Panel Removal** and **Positioning the Motorcycle on a Jack** portions of this manual), you must remove the front or rear brake caliper (see the **Front Brake Pad Inspection and Removal** and **Rear Brake Pad Inspection and Removal** portions of this manual), and you must remove the affected wheel (see the **Front Wheel Removal** and **Rear Wheel Removal** portions of this manual).

After removing the front wheel, gently pry the dust cover from the bearings.



Remove the dust covers.



Using a suitable bearing removal tool inserted into the bearing inner race, remove the bearing.



CSC stocks wheel bearings, so call us at 909 445 0900 if you need to order new bearings.

Assembly is the reverse of disassembly.

## Suspension

Front and rear suspension maintenance activities are described below.

## Front Fork Seal Replacement

In order to remove the motorcycle's fork seals, you must first place the motorcycle on a jack or other suitable support (see the Body Panel Removal and Positioning the Motorcycle on a Jack portions of this manual), you must remove the front or rear brake caliper (see the Front Brake Pad Inspection and Removal and Rear Brake Pad Inspection and Removal portions of this manual), and you must remove the front wheel (see the Front Wheel Removal portion of this manual).

The front fork contains 176 cc of oil.

Remove the Allen bolts securing the panel to the affected fork leg.



Loosen the lower triple tee pinch bolts.



Loosen the upper triple tee pinch bolts.

**Caution!** Make sure you support the front fork when you loosen the upper and lower triple tee pinch bolts.



Carefully slide the fork out of the triple tees.



Gently pry the fork dust seal out of the fork upper tube.



Carefully unclip the spring clip below the fork seal using a flat bladed screwdriver.

**Caution!** Take care not to scratch the fork upper.



This photo shows the spring clip removed.



Using an impact wrench, unscrew the fork upper cap from the fork upper.





Withdraw the fork internals.



Using a wrench on the hex head shown, separate the fork internals from the fork cap.



These two pieces will separate. After doing this invert the fork and collect the fork oil in a suitable container. Then, withdraw the fork internals from the fork upper section.



At this point, the fork seal will be accessible.



Gently pry the fork seal from the fork upper tube.

**Caution!** Take care not to scratch the fork upper. Use a piece of rubber or other suitable material to protect the fork tube when doing this.



CSC stocks fork seals, dust covers, spring clips, and fork oil, so call us at 909 445 0900 if you need to order these parts.

Assembly is the reverse of disassembly.

### Rear Shock Absorber Adjustment

Preload can be adjusted on the rear shock absorber. You can increase or decrease the rear shock absorber preload. To make this adjustment, put the motorcycle on its sidestand.

Using a spanner wrench, loosen the preload adjustor locknut.



Using a spanner wrench, adjust the preload adjustor nut up to increase the preload, or down to decrease the preload.



Using a spanner wrench, tighten the locknut to lock the preload adjustment nut in place.



### Rear Shock Absorber Replacement

**Warning!** Support the motorcycle on a jack beneath the battery area prior to attempting to remove the motor. If you do not, the motorcycle will fall down when you disconnect the shock absorber.

Remove the rear shock lower attach point on the motor.

Remove the motorcycle bodywork around the upper shock mount and detach the upper shock mount.



Assembly is the reverse of disassembly.

Note that the rear shock absorber is a non-repairable item. CSC stocks rear shock absorbers. If you need a new shock absorber, please call CSC at 909 445 0900.

### Wheel and Tire Inspection and Maintenance

Check if the tire air pressure is at the specified value (32 psi front and rear). Inspect the valve stems for security, and valve stem condition. Do not operate the motorcycle without the valve stem cap in place. Inspect the tire condition.

**Warning!** Replace any tire with tread that is worn down to the tread wear indicator (or if the tread remaining is less than 2mm), if the tire exhibits cupping, or if the tire has any other defects.

Check the rims for dents. If the rim is dented, it should be replaced.

When the wheels are removed from the motorcycle, check the grease seals, the wheel bearings, and other components. If the grease seals are cut or torn, they should be replaced. If the wheel bearing inner races are loose, gritty when rotated, or noisy, replace the bearing.

Place the wheels on a truing stand and inspect them for runout and ovality. If either exceeds 1.0mm, replace the wheel.

Balance the wheel and tire on a dynamic balancer.

### Wheel and Tire Troubleshooting

Item	Symptom	Cause	Vehicle Effect	Maintenance Action
Wheel and Tire	Vibration	Deformation, out of balance condition, worn tire, wheel trueness or ovality outside of spec limits, worn bearing, motorcycle load	Drift, handlebar shake, vibration	Check bearings, check inflation pressure, check tire condition, balance tire and wheel, check for proper loading of motorcycle
Tire	Premature wear, cupping	Out of balance, misaligned rear wheel, worn bearing, under or over inflated.	Premature tire wear	Check bearings, check inflation pressure, balance tire and wheel, check for proper loading of motorcycle

### Replacing Tires

If your motorcycle has a flat tire, check for any obvious causes on the outside of the tire (it will make finding the leak easier). If the tire is worn excessively, it needs to be replaced.

Prior to lifting the bike to get the wheel with the tire to be replaced off the ground, loosen the axle bolts (just loosen them at this point, do not remove them). Note that the photos shown in this section of the Service Manual are photos of the RX3 motorcycle. The concepts are the same for the City Slicker motorcycle.

Remove the wheel with the flat tire in accordance with the instructions for doing so in this manual. Place the wheel on its side, with the brake disk facing down. Remove the valve cap and depress the Schrader valve to allow any remaining air in the tube to escape. Loosen the nut around the valve stem, and then unscrew it completely by hand.



Break the bead around the tire. Usually, just stepping on the tire (as shown below) will unseat the tire from the rim. After you've broken the bead, spray the area between the bead and the rim with a rubber lubricant designed for tire mounting.



Using a tire iron (you'll need two), insert the tip between the tire and the bead, and pull the bead over the rim. Using the second tire iron, pick a location about 6 inches away (measured circumferentially on the rim) and do the same thing. Remove the first tire iron and repeat the process. You usually only need to do this once and the tire will pop off the rim on the side you're working. Repeat the process to get the other side of the tire off the rim.

**Caution!** Take care not to scratch or gouge the wheel while removing the tire.

Reinstall the tire on the rim using tire irons. Liberal use of spray lubricant will help.

Reinstall the tire and wheel on the motorcycle before you inflate the tube.

After accomplishing the above, inflate the tire and to seat it on the rim.

If you need a new tire or other items required for tire replacement, please call CSC at 909 445 0900.

## Drive System

The City Slicker drive system consists of the motor, the pulleys, the drive belt, and the cush drive.

## Rear Wheel Alignment and Drive Belt Adjustment

The toothed drive belt should be adjusted for minimal slack.

**Caution!** Do not overtighten the belt. If the drive belt is overtightened, it will adversely affect motorcycle performance, belt life, and motor life.

Place the motorcycle on its sidestand. It is not necessary to lift the motorcycle off the rear wheel to make this adjustment.

There should be approximately 1/8-inch of vertical play in the belt halfway between the motor drive pulley and the rear wheel pulley.

The drive belt, as shown on the rear wheel pulley.



The Allen bolt positioner and its locknut are used to position the rear wheel.



Loosen the axle bolts on the right side of the motorcycle. Note the scribe marks on the axle adjustment block and the vertical alignment scribe line on the swingarm (top arrow). With the axle loosened, position the rear wheel using the Allen bolt and nut (shown by the left two arrow) such that the adjustment block is at the same position on the left and right of the motorcycle, and appropriate belt tension is achieved. Tighten the axle nut and the adjusters.



The left side of the rear axle and the swingarm.



### Cush Drive Replacement

The City Slicker motorcycle has a cush drive. If the motorcycle drive train feels erratic or snatchy when starting, it may be due to cush drive degradation. In that case, the cush drive cushions should be replaced.

Remove the rear wheel in accordance with the rear wheel procedure in this manual.

Lift the drive pulley off of the rear wheel.



Once the drive pulley has been removed from the rear wheel, place the bushing (denoted by the arrow on the right) that fits between the pulley and the rear wheel in a secure place. Note that there are 4 cush drive cushions (denoted by the left arrow).



Remove the four cushions.



Assembly is the reverse of disassembly.

If you need new cush drive pads, please call CSC at 909 445 0900.

### Motor Removal and Replacement

**Warning!** Remove the battery from the motorcycle before attempting to remove the motor and before attempting to remove disconnect the controller.

**Warning!** Support the motorcycle on a jack beneath the battery area prior to attempting to remove the motor. If you do not, the motorcycle will fall down when you disconnect the shock absorber.

Detach the controller and disconnect the controller terminals, as outlined in the controller removal section of this manual. Pull the motor harness down and out of the motorcycle.

Remove the rear brake caliper, as outlined in the rear caliper removal section of this manual.

Remove the rear wheel, as outlined in the rear wheel removal section of this manual.

Remove the drive belt, as outlined in the drive belt removal section of this manual.

Remove the left and right motor covers from the swingarm.



Remove the rear fender from the swingarm.



Disconnect the rear shock absorber from the motor.



Remove the Allen bolts securing the motor to the left and right legs of the swingarm.



Remove the motor from the swingarm.



Remove the rear shock absorber mount from the motor.



Remove the drive pulley from the motor.



Assembly is the reverse of disassembly.

The motor is a non-repairable item. If you need a new motor, please contact CSC at 909 445 0900.



## Belt Replacement

The belt has a service life of approximately 20,000 miles. You should remove and replace the drive belt every 20,000 miles.

Remove the rear axle in accordance with the rear wheel removal procedure outlined in this manual.

Push the wheel forward and take the belt off the rear wheel pulley.



Remove the left motor cover.



Remove the drive belt from the motor pulley.



Assembly is the reverse of disassembly. Install the new belt. Align the rear wheel in accordance with the belt adjustment and rear wheel alignment procedure shown in this manual.

If you need a new drive belt, please call CSC at 909 445 0900.

## Electrical System

The City Slicker electrical system consists of the instrumentation, the turn signals, the switches, the lights, the controller, a fuse, a circuit breaker, the horn, and associated harnesses and circuitry.

### Electrical Components Location

The City Slicker's electrical components are located under the seat (the DC converter, the fuse, and connector plugs and harnesses), in the battery compartment (the battery, the controller, and harnesses and related connectors), in the headlight/instrument cluster (lamps, harnesses, and related connectors), in the handlebars (the switches), in the turn signals (LED assemblies), and on the frame in front of the battery compartment (the horn). Access to the underseat components is provided by using the ignition key in the lock on the left body panel and removing the seat. These components are shown below.

Insert the ignition key in the left underseat body panel and turn it to unlock the seat.



Lift the seat off the motorcycle.



Air switch.



DC converter.



Plug for external test equipment (not provided with motorcycle).



Flasher unit.



10A fuse holder.



10A fuse and spare. If you need to replace the fuse, locate and correct the source of the short circuit prior to replacing the fuse.



CSC stocks replacement electrical components. If you need replacement components, please contact CSC at 909 445 0900.

## Headlight Replacement

Remove the two Allen bolts on either side of the ignition lock.



Tilt the headlight and instrument cluster module forward.



Lift the headlight and instrument cluster off the locking pegs.



Move the harnesses to provide access to the headlamp rear rubber cover.



Remove the rear rubber cover from the headlight.



Remove the headlight connector.



Unlock the white plastic headlamp socket retainer.



Remove and replace the headlamp.



Install a new headlamp.



Assembly is the reverse of disassembly.

CSC stocks replacement lamps. If you need a replacement lamp, please contact CSC at 909 445 0900.

### **Instrument Cluster Removal and Replacement**

The instrument cluster is attached to the headlight assembly with two threaded fasteners accessible from the underside of the headlight subassembly. To gain access, you will need to remove the headlight subassembly as outlined in the headlight replacement segment of this manual. Disconnect the fasteners and the connectors. The instrument cluster is not a repairable item; it must be replaced as a subassembly.

CSC stocks replacement instrument clusters. If you need a replacement instrument cluster, please contact CSC at 909 445 0900.

### **Ignition Switch Removal and Replacement**

To replace the ignition switch module, remove the headlight and instrument cluster as described above to get access.

The ignition switch module is provided with a new ignition key. Note that after replacing the ignition switch module, you will either need to replace the battery and seat release locks, or you will need to keep the keys to operate those locks. The new key will not fit these other locks.

Disconnect the ignition switch connector.

Remove the two bolts securing the ignition switch module to the upper triple tee.



Assembly is the reverse of disassembly.

CSC stocks replacement ignition switch modules. If you need a replacement ignition switch module, please contact CSC at 909 445 0900.

## Front and Rear Turn Signal/Brake Light Replacement

The detailed procedure for removing and replacing the rear turn signal/brake light LED subassembly is outlined in the photos that follow. Doing so involves removing the rear seat and two body panels to gain access. Removal and replacement of the front turn signals is far more straightforward.

Remove the rear seat by inserting the ignition key in the left body panel and turning it.



Remove the rear seat.



Remove the Allen bolt securing the turn signal body panel to the frame.



Remove the Allen bolts securing the silver trim piece from the frame.



Remove the silver trim piece from the frame.



Remove the Allen bolt beneath the LED subassembly.



Remove the Allen bolt beneath the black plastic trim piece.



Remove the Allen bolt on the lower trim panel.



Remove the Allen bolt at the top and rear of the black plastic trim panel. Remove the white plastic lower body right panel.





Remove the Allen bolt securing the LED subassembly body panel to the motorcycle frame.



Disconnect the electrical connector.



Unscrew the four Phillips head screws securing the LED subassembly from the body panel.



Remove the LED subassembly from the body panel. The LED subassembly is a non-repairable unit; it must be replaced as a subassembly if defective.



The procedure for removal and replacement of the front turn signal LED subassemblies is much more straightforward. Unbolt the affected turn signal, disconnect the connector plug, and replace the component.

Assembly is reverse of disassembly.

CSC stocks front and rear turn signal/brake light subassemblies. If you need replacement components, please contact CSC at 909 445 0900.

## License Plate Light Replacement

Remove the Allen bolt beneath the license plate lamp.



Pull the license plate lamp subassembly out and unscrew the two Phillips head screws securing the lamp to the mount. Replace the lamp.



Assembly is the reverse of disassembly.

CSC stocks replacement license plate light components. If you need a replacement parts, please contact CSC at 909 445 0900.

## Controller Removal and Replacement

The controller is located above the battery and below the motorcycle storage area.

**Warning!** Never attempt to do any work on the controller without first removing the battery in accordance with the instructions in this manual.

**Warning!** The controller is not repairable item. If it has a fault, it must be replaced. Never attempt to repair and reuse a defective controller.

**Warning!** The controller gets hot during use. Allow the controller to cool before attempting to remove it.

Place the motorcycle on its sidestand and remove the battery in accordance with the battery removal section of this manual.

The controller is secured in the motorcycle frame by four bolts on the left and right side of the controller. These are somewhat difficult to access. Remove all four bolts and cut any zip ties securing the controller harnesses. Gently pull the controller down into the battery compartment.



Remove the two terminal connector cover screws with a Phillips head screwdriver.



Remove the two terminal connector cover screws with a Phillips head screwdriver.



Disconnect all four controller terminals.



There are two connectors on the rear of the controller.  
Disconnect the connectors.



At this point, the controller can be removed from the motorcycle.

Assembly is the reverse of disassembly. If you have a defective controller, please contact CSC at 909 445 0900 for a replacement.

### **Built In Test Equipment and Electrical System Troubleshooting**

If a fault is present, the indicator shown in the No. 19 position illuminate. The City Slicker's built in test equipment will identify the fault number by pressing the No. 1 switch.

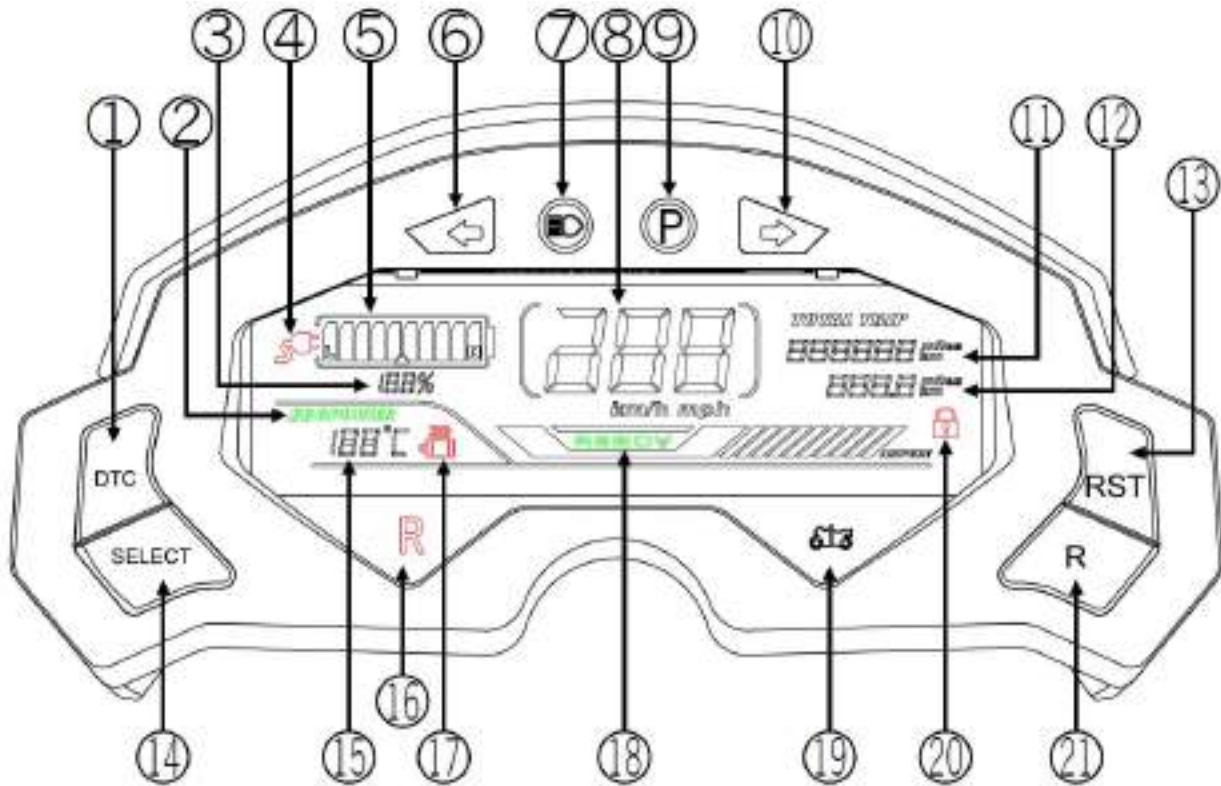

The built-in test equipment fault code legend is shown below.

Code	Description	Code	Description
001	Controller overheating protection	011	Charging overcurrent
002	Controller overvoltage protection	012	Overheated motor
003	Controller undervoltage protection	013	Cell standalone overvoltage protection
004	Controller overcurrent protection	014	Battery overall overvoltage protection
005	Rotation-clogging protection	015	Overly cell dropout voltage
006	HALL trouble	016	Discharging overcurrent
007	Controller self-testing trouble	017	Instrument self-testing failure
008	Handlebar trouble	018	Instrument power supply trouble
009	Overheated battery	019	Instrument coulombmeter testing trouble
010	Charging overvoltage	020	Instrument current meter testing trouble

Electrical Schematic

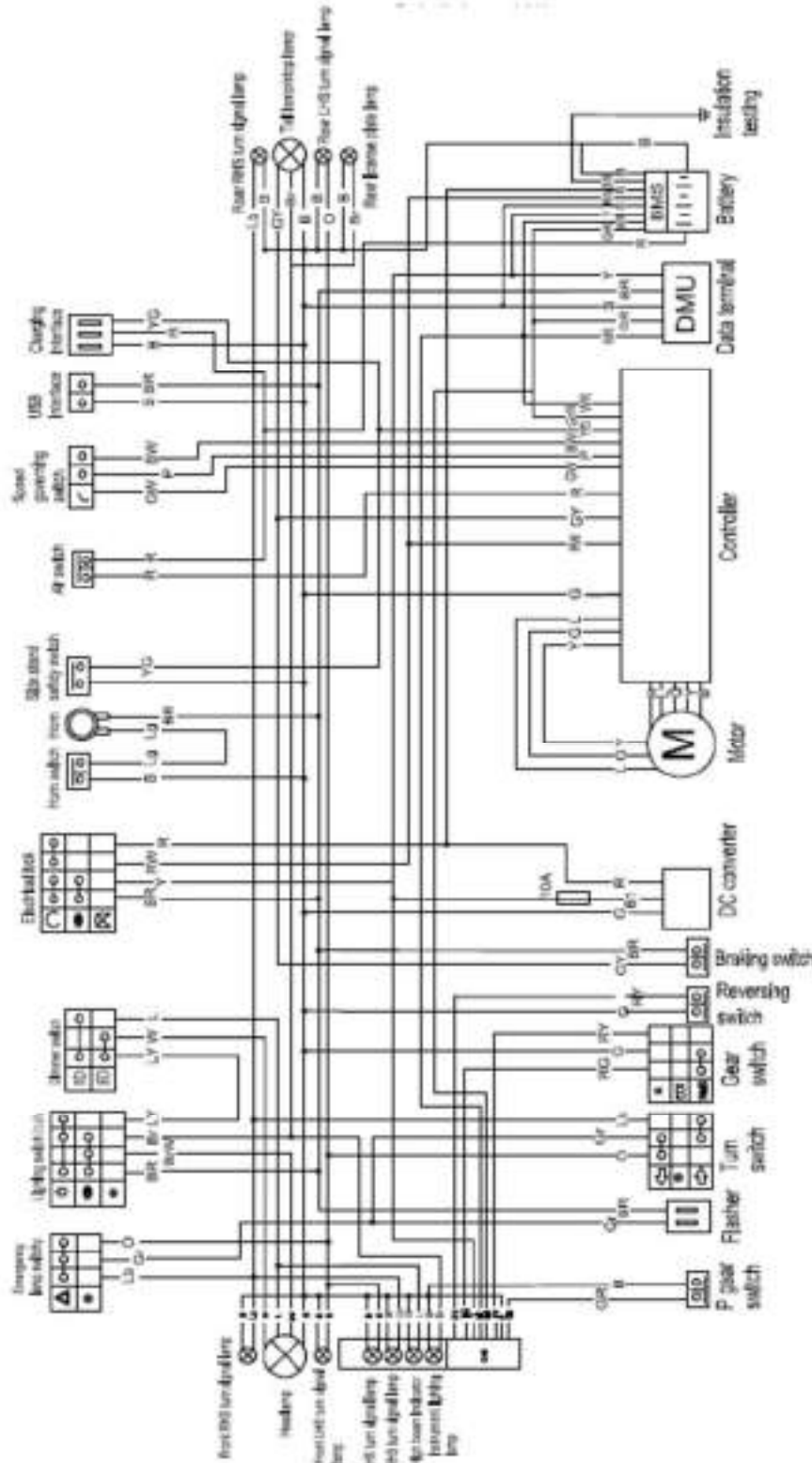

Black---B, White---W, Yellow---Y, Blue---Bl, Green---G, Red---R, Brown---Br,  
Grey---Gr, Light blue---Lb, Light green---Lg, Orange---O, Pink---P, Purple---Pu.