

USER'S MANUAL

Motorini SMR/SXR 125



Introduction

Thank you for choosing to buy a Motorini Motorcycle. This manual explains the use, operation, basic inspection and maintenance, etc. If you have any question about the operation and maintenance, please contact your dealer.

To maintain your motorcycle in a good serviceable and safe condition, please carry out the scheduled maintenance and instructions in this manual.

The following important information will appear in this manual:

⚠Caution:

Refers to procedures that must be followed. Otherwise, your personal safety may be endangered.

⚠Notice:

Refers to procedures that must be followed to avoid damaging the motorcycle.

⚠Warning:

Refers to procedures that must be followed to avoid injury to you, other person or the motorcycle.

Note:

Note

<p>Our company is constantly working to improvement product design and quality. This manual contains the latest product information at the time when it is printed. However, it is possible that the manual may be more or less different with your motorcycle. If you have any question, please contact your dealer.</p>
--

⚠Warning

<p>Read this manual carefully before driving the motorcycle</p>
--

Contents

Introduction	1
Contents	2
Precautions for Safe Riding	4
Identification	5
The Serial Number	7
Functions of Controllers	8
Instrument Panel Indications	8
Ignition switch	11
Switches on the Handlebars	12
Brake Levers	13
Throttle Grip	14
Gear Shifting	14
Side Stand	15
Fuel Tank Cap	15
Scat Lock	16
Fuel and Oil Recommendations	17
Running-in of New Motorcycle	18
Inspection before Riding	19
Inspection the Braking effect and the free play	19
Inspection of the Tyre	19
Inspecting the Quantity of Fuel	20
Inspecting the Quantity of Engine Oil	20
Inspection of the Ignition Unit and the Lights	20
Inspecting the Rear Mirror	20
Riding Tips	21
Inspection and Maintenance	24
The first service	24
Maintenance Schedule	25

Engine Oil	26
Battery	27
Spark Plug	27
Air Filter	28
Carburetor	29
Tyres	30
Brake circuits	31
Fuel Hose	32
Fuse	32
Troubleshooting	33
Storage Procedures	34
Specifications	35
Circuit Diagram	37

Precautions for Safe Riding

Please obey local traffic regulations. It is advised to control your speed within safe limits.

Practice before Riding

Before riding the motorcycle, practice in a spacious and traffic-free place so that you are familiar with the motorcycle's controls. Practice is essential to safety.

Knowing Your Safe Speed Limit

Safe speed limits varies in accordance with the road conditions, riding skill and the weather.

Be Careful in the Rain

It is more dangerous to ride on a moist or wet road. Therefore, high speed should be avoided and special care should be taken when turning. Keep in mind the braking distance on a wet road is greater than in the dry.

Helmet

Wear a helmet whenever you ride, and fasten the strap whenever you wear the helmet.

Clothing Recommendation

Hi-Viz and well-fitting clothes are recommended. Make sure that the clothes allow the limbs to move freely.

Specialist motorcycle clothing and footwear are recommended.

Indispensable Maintenance and Inspection

The following items are indispensable:

- ✧ Inspect your bike before riding.
- ✧ If covering low mileage, ensure you have a half year inspection.
- ✧ Adhere to the Maintenance Schedule.

Care of the Exhaust

The high temperature of the Exhaust can burn. Please park your motorcycle where there is little chance of it touching anything.

Modification

Modification to the motorcycle may invalidate your warranty, consult your dealer first.

Identification

Read the following labels carefully before using the motorcycle.

- | | | | |
|--------------------|------------------------|----------------------|---------|
| 1. Rear lamp | 2. Rear turning lamps | 3. Exhaust | 4. Seat |
| 5. Throttle grip | 6. Front turning lamps | 7. Head lamp | |
| 8. Rear disc brake | 9. Rear brake pedal | 10. Front Suspension | |



-
- | | | | |
|----------------|----------------------|----------------------|---------------|
| 1. Speedometer | 2. Rear-view mirrors | 3. Left switch | |
| 4. Carburetor | 5. Air filter | 6. Rear reflector | 7. Side stand |
| 8. Shift pedal | 9. Side reflector | 10. Front disc brake | |

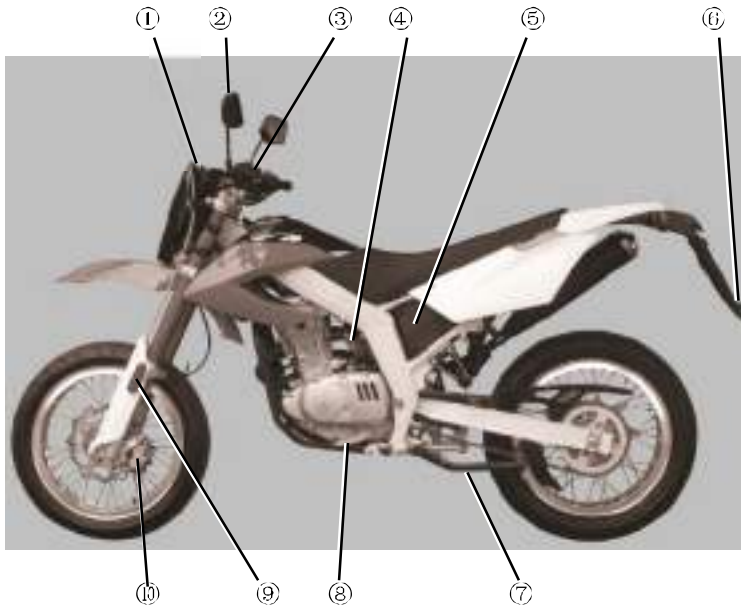

The Serial Number

Engine number

The Engine number is stamped on the side of the crankcase assembly.

Note

Remember your engine number for purchasing correct spare parts from your dealer.
--

Chassis number

The Chassis number is stamped on the frame.

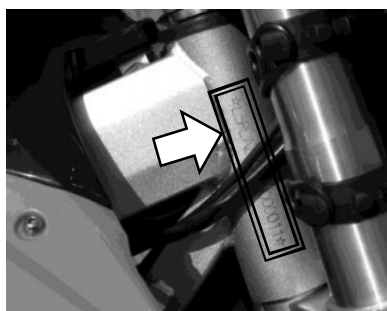

Chassis number



Engine number

Please write down the serial numbers below for future reference.

Chassis Serial No. :

Engine Serial No. :

Functions of Controllers

Instrument Panel Indications

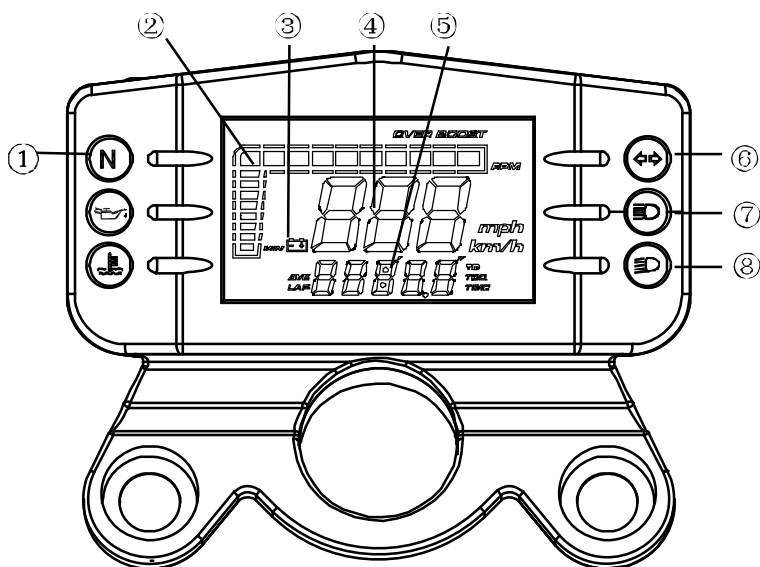

1. Neutral Gear Indicator(N)

The green light will be lit when the gearshift is in the neutral mode.

2. Tachometer

The tachometer shows the engine speed bars.

For the correspondence between the bars and engine speed see the following form.

RPM	Bars	RPM	Bars
0	0	6400~7000	10
100~1600	1	7100~7700	11
1700~2000	2	7800~8400	12
2100~2400	3	8500~9100	13
2500~2800	4	9200~9800	14
2900~3500	5	9900~10500	15
3600~4200	6	10600~10900	16
4300~4900	7	11000~11300	17
5000~5600	8	11400~11700	18
5700~6300	9	11800~	18+OVER REV

3. Low Voltage Indicator

If this indicator is on, it means the voltage of the battery or charging circuit is lower than 11.5V.

4. Speedometer

The speedometer shows the speed at which you are riding in kmh or mph.

5. Odometer

The odometer registers the total distance that the motorcycle has been ridden.

You can press the Setting Button to set the meter, please see the list below.

5.1 Setting the diameter of the wheel

Display	Press time	Result
TDO	>3s	enter the setting of wheel diameter, thousands digit if flash
thousands digit if flash	>3s	hundreds digit is flash
hundreds digit is flash	>3s	tens digit is flash
tens digit is flash	>3s	units digit is flash
units digit is flash	>3s	enter the speed units setting
any digit is flash	<3s	digit plus 1

5.2 Setting the speed units

Display	Press time	Result
speed units is flash	>3s	return TDO
speed units is flash	<3s	switch between km/h and mph

5.3 Setting the time

Display	Press time	Result
TIME	>3s	enter time setting hour-digits is flash
hour-digits is flash	<3s	hour-digits plus 1 between 0~23
hour-digits is flash	>3s	minute-digits is flash
minute-digits is flash	<3s	minute-digits plus 1 between 0~59
minute-digits is flash	>3s	return to TIME

5.4 Trip distance, Time counting, Average speed return to zero

Display	Press time	Result
TD	>3s	trip distance record return to zero
LAP	>3s	time counting record return to zero
AVE	>3s	average speed return to zero

6. Direction Indicator

When the turning switch lever is set to left or right, the Direction Indicator will flash.

7. High Beam Indicator

The indicator light when the high beam is on.

8. Low Beam Indicator

The indicator light when the low beam is on.

Ignition switch

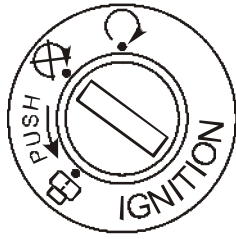

Rotate the key to turn power ON or OFF.

ON	The engine can be started Possible to drive It is impossible to pull out the key.
OFF	The engine cannot be started. The engine is stopped The key can be inserted or pulled out
LOCK	The handlebars can be locked to one direction. The key can be inserted or pulled out.

When you leave the motorcycle, you may lock the handlebars to prevent your motorcycle from being stolen.

1. Turn the handlebars to the left.
2. Insert the key (if it is not in) from OFF position. Press the key in and turn it anti-clockwise to the LOCK position.
3. Pull out the key.

To unlock the handlebars, insert the key from the LOCK position and turn it (without pressing it) clockwise to the OFF position.

Note

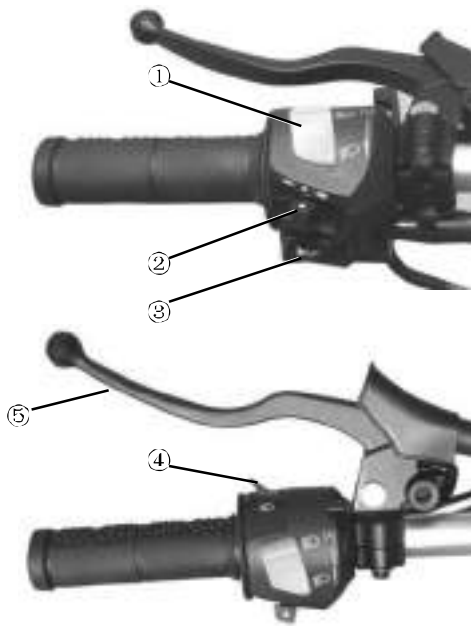

- | |
|---|
| <ul style="list-style-type: none">◇ Swing the handlebars to check if they are locked.◇ If it is hard to lock, you may turn the handlebars slightly rightwards and try again. |
|---|

Switches on the Handlebars



①. Dimmer Switch

This switch is used to change the headlamp beam. When you turn the switch to:

HIGH 	The high beam is turned on.
LOW 	The low beam is turned on.

②. Turning Signal Lamp Switch

This switch is used to turn on/off the left/right turning signal lamps to show other vehicles that you want to turn left/right. When you turn the lever to:

Right	The right signal lamps flash.
Left	The left signal lamps flash.
Center	Push in the switch at the center position to cancel the turn-signal operation.

Please turn off the indicators when they are no longer necessary or

your turn is complete. Incorrect indicator display can be very dangerous.

③ Horn Button

Press this button to sound the horn.

④ High Beam Flash Button

Press this button to light the high beam temporarily.

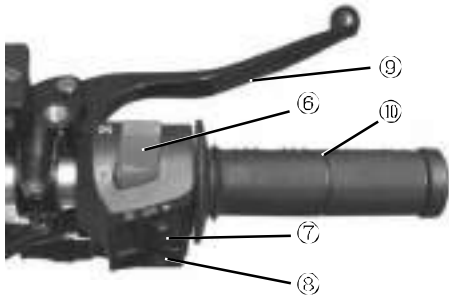

⑤ Clutch Lever

Grip this lever to disengage drive at the time of starting the engine or shifting the gear. Disengage the clutch by pulling the lever to the handlebar.

⑥ Stop Switch of Engine

This switch, located on the top of the control panel of the right handlebar. When it is on the “○” position, the engine can be started.

If the switch is on the “⊗” position the engine cannot be started.

⑦ Headlamp Switch

Turn the switch to position:

 : The headlamp, instrument lamp, rear lamp will be on.

 : The front and rear position lamp will be on.

● : The headlamp, instrument lamp, rear lamp will be off.

⑧ Starter Button

This button is used to start the engine. Turn the ignition key to ON, squeeze the rear brake lever and press the button, the engine will start.

Brake Levers

By operating the brake levers ⑨, you can control the speed of the

motorcycle and even make it stop. The brake is applied by squeezing the brake lever gently towards the grip. The brake light will be lit when the lever is squeezed inward.

Throttle Grip

Throttle grip ⑩ is used to control engine speed. Turn it towards you to increase engine speed; Turn it away from you to decrease the engine speed.

Gear Shifting



This model of motorcycle is equipped with a five-shift gear-in transmission system. The working order of the gearshift is as shown in the fig.

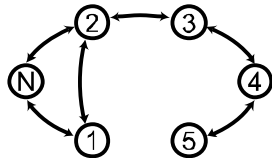

The lever is connected to the ratchet of the gearshift. It will return automatically to its original position after selection of a certain gear so that it is possible to change to the next gear. The neutral gear is located between the first and second gears. In the neutral mode, press the lever and first gear will be engaged, each time the lever is shifted up, a higher gear is engaged.

Side Stand



Fuel Tank Cap

The fuel tank cap is provided with a latch.

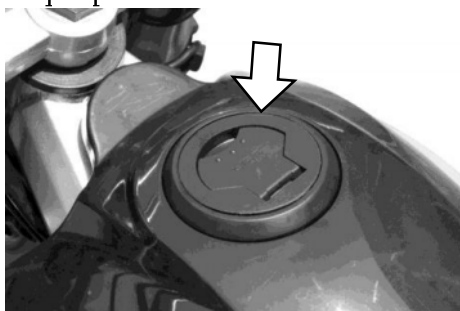

To open it:

1. Lift the protection plate of the latch.
2. Keeping the tap in the locked position turn the latch to the left side and then, remove the cap.

 Warning
--

The sealed cap can increase slightly the pressure in the tank, so it is normal that you hear a noise produced by the air when it comes out.

To close it:

1. Insert the cap with the key;
2. Turn the key to the right side and remove it.

Seat Lock



To open and close the seat as follows:

1. The seat lock lever is under the seat, press the seat down and turn the seat lock lever then lift the seat. The seat will be opened.
2. Push the seat gently and it will be locked automatically. Lift the seat gently to check if it is locked.

Fuel and Oil Recommendations

Fuel

Use unleaded petrol with an octane number 90 or higher.

Engine Oil

Use of high quality 4-stroke engine oil will extend the lifetime of the engine. Grade SE or SD engine oil of the API scale is recommended; whose viscosity is SAE10W-40. If this oil is not available, please purchase appropriate substitutes according to the data listed below.

Motorini recommends Global Racing Oil lubricants.

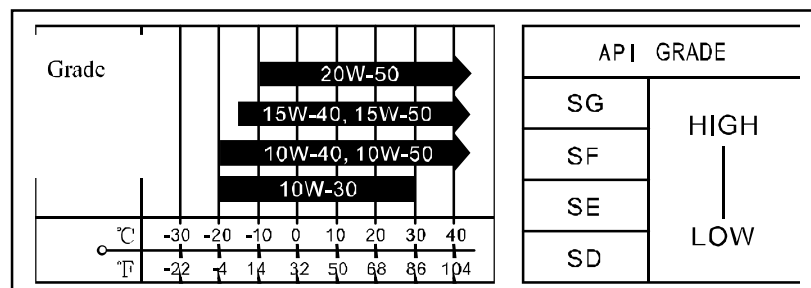

Transmission Oil

Use good quality SAE 10W-40 multi-grade motor oil.

Motorini recommends Global Racing Oil lubricants.

Running in of New Motorcycle

The first 1600km/1000 miles are the most important in the life of your motorcycle. Proper running-in during this period will help ensure maximum life and performance from your new motorcycle.

Maximum Throttle Operation Recommendations

This table shows the maximum recommended throttle operation during the running-in period.

Initial 800km/500mils	Less than 1 2 throttle
Initial 1600km/1000mils	Less than 3 4 throttle

Vary the engine Speed

The engine speed should be varied and not held at a constant speed.

Allow the Engine Oil to Circulate before Riding

Allow sufficient idling time after cold engine start up before applying load or revving up the engine. This allows time for the oil to reach all critical engine components. It is also advised to allow a warm engine to circulate oil before revving.

First Service

The 1000km/600mils service is the most important service your motorcycle will receive. During running-in the engine components will have bedded in and all of the parts will be seated. Adjustments will be checked, all fasteners will be tightened, and the used oil will be replaced.

 Caution

The 1000km/600mils service should be performed as outlined in the service and warranty book supplied. Pay attention to the information and guidance given.
--

Inspection before Riding

Before riding the motorcycle, be sure to check the following items. Never underestimate the importance of these checks. Perform all of them before riding the machine.

WHAT TO CHECK	CHECK FOR
Steering	1) Smoothness 2) No restriction of movement 3) No play or looseness
Brakes	1) Correct brake lever play 2) No obstruction in braking.
Tyres	1) Correct pressure 2) Adequate tread depth 3) No cracks or cuts
Fuel	Enough fuel for the planned distance
Lighting	Operate all lights —headlamp, tail lamp, brake lamp, turning lamps
Indicators	Oil indicator and turning indicator
Horn	Correct function
Engine oil	Correct level
Throttle	1) Correct play in the throttle cable 2) Smooth operation and positive return of the throttle grip to the closed position

Brake Inspection

Hold the brake levers until you feel resistance, measure the travel at the lever ends. The distances should be 10~20mm.

Inspection of the Tyre

1. Tyre Pressure

Check it with a tyre pressure gauge and adjust it to the correct value.

Tyre Pressures

Front Wheel	26 psi
Rear Wheel	33 psi

-
2. Check the surface of the tyre:
- ✧ Is there any obvious damage?
 - ✧ Are there any nails etc. in the tyre or in the tread?
 - ✧ Is there any abnormal wear?

Inspecting the Quantity of Fuel

Make sure you have enough fuel to reach the destination. Turn the ignition switch to ON position, if the fuel gauge hand points to the red region, fuel should be refilled as soon as possible.

Inspecting the Quantity of Engine Oil

Refer to page 24, to check the engine oil.

Inspection of the Lights

Start the engine, check if the headlight and the rear light are on.

Operate the front and rear brake separately, and check if the brake light is illuminated.

Operate the turning signal lamp switch, and check if the turn signal lights work normally.

Inspecting the Rear Mirror

Check if the back and side objects can be seen clearly from the rear mirror at the driver's position.

Inspecting the Reflectors and the Licence Plate

Check if the number plate and the reflectors are clean and not damaged.

Riding Tips

Start the Engine

 Caution

Before starting, you must:

- ◇ Check the quantity of fuel and engine oil.

Insert the ignition key into the ignition switch and turn it to ON

When the engine is cold:

1. Squeeze the front brake lever.
2. Apply the choke.
3. Push the starter button.
4. Let the engine warm up after being started.

When the engine is warm:

1. Squeeze the front brake lever.
2. Open the throttle 1/8~1/4.
3. Push the starter button.

 Caution

- ◇ Release the starter button soon after the engine is started. Otherwise damage may be done to the engine.
- ◇ To protect the battery from exhaustion, if the engine has not started after 5 seconds, please restart using the kick-starter and check if there are any problems with the starting system.
- ◇ If the engine remains un-started after several attempts at starting, turn the throttle grip by 1/8~1/4 and try again. The grip should be released soon after the engine is started.

Start off

1. Mount the motorcycle.

While holding the handlebars with both hands, mount the motorcycle from left side and sit on the seat. Support yourself with your left foot.

 Caution

Do not turn the throttle grip before you are ready to go.

2. Look around to see if it is safe to proceed.

Make clear your intention to move off by switching on the indicators. Look around to judge the safe condition. You need to squeeze the front brake lever all the time before you set out.

 Caution

Special attention should be paid to the traffic approaching you from behind.

3. Start off

Release the brake lever and gradually rotate the throttle grip to let the motorcycle speed up slowly.

 Caution

Excessive rotation of the grip can lead to danger in the form of sudden acceleration

4. Adjusting Speed

The speed of your motorcycle is adjusted by turning the throttle grip. Rotate the grip to speed up. Gradual rotation is recommended. Release it to slow down. Quick release is advisable.

5. Apply Brakes

Combined application of both brakes is recommended. Adjust according to road conditions.

Quickly release the throttle grip to the minimum position and squeeze the brake levers.

It is most advisable to reduce the speed slowly by gradual application of the brakes.

 Caution

- ◇ Single braking of the front or rear wheel may cause you to slide.
- ◇ Quick braking or sharp turning are the major causes of side slides or falls and are therefore extremely dangerous.

6. Special care should be taken on rainy and snowy days.

Moist and wet road surface may cause danger. Sharp turning in the course of acceleration should be avoided. An appropriate distance should be kept from the vehicles ahead. Keep in mind that the braking distance in wet weather is greater than the dry.

7. Check the brakes after washing or riding in water.

After washing or riding in water, the braking effect may be reduced. If this occurs, reduce speed and apply less braking effort until the brakes are

restored to normal function.

 Caution

Never park your motorcycle on a slope or a loose surface, so that the motorcycle won't fall over.

8. Lock the steering

When you leave the motorcycle for a while, lock the steering to protect your motorcycle from theft.

Inspection and Maintenance

The maintenance schedule below indicates the intervals between periodic services tasks. Please follow the schedule in your Service and warranty book to maintain your warranty and integrity of your motorcycle. At the end of each interval, be sure to inspect, check, lubricate and service as instructed. If your motorcycle is used under heavy load conditions such as continuous full throttle operation or is operated in a dusty climate, certain services should be performed more often to ensure reliability of the machine as explained in the maintenance section. Your dealer can provide you with further guidelines. Steering components, suspensions and wheel components are key items and require very special and careful servicing. For maximum safety we suggest that you have these items inspected and serviced by your dealer or a qualified service mechanic.

The first maintenance

The maintenance after first 1000km/600mls is the most important. During running in, all engine parts bed in to adjacent parts. It is therefore essential all parts should be adjusted for tolerance; all fasteners retighten and contaminated engine oil replaced.

To guarantee the engine with a long service life and a good performance, carry out the 1000km/600mls maintenance on time. Failure to do so will invalidate your warranty.

 Caution
--

<p>Where servicing requires replacement parts we recommend that only genuine parts are used. For your own safety we recommend that all servicing and maintenance is carried out by an authorized dealer or independent motorcycle dealership. Whilst you are actively encouraged to carry out daily safety and maintenance checks, we urge you to leave scheduled maintenance to the professionals.</p>

Maintenance Schedule

Intervals	km	1000	3000	6000	9000	12000
*Nuts at cylinder head and exhaust pipe		T	T	T	T	T
*Cylinder head, cylinder and muffler		-	C	C	C	C
Carburetor		I	I	I	I	I
Air filter	Cleaning every 1500km					
Spark plug		I	I	R	I	R
Fuel hoses		I	I	R	I	R
Transmission oil		R	-	R	-	R
Engine oil pump		I	I	I	I	I
*Brakes		I	I	I	I	I
*Front fork		I	I	I	I	I
*Steering		I	I	I	I	I
*Rear suspension		I	I	I	I	I
Tires		I	I	I	I	I
Fastening nuts and bolts		T	T	T	T	T
Lubrication of cables		-	Grease	-	Grease	-

NOTE: I=Inspect and clean adjust lubricate or replace if necessary,
 C=Clean, R=Replace, T=Tighten

Engine Oil

1. Keep the vehicle in an upright position.
2. Start the engine, let it idle for a few minutes and then switch it off.
3. Wait at least five minutes to let the oil settle and find its natural level.
4. Loosen the dipstick.

⚠ Caution

Do not add different oil that is not recommended for the engine.

5. Clean the dipstick of oil residues and introduce it again without screwing it back in. The correct oil level must be between the reference marks "B" and "C".
6. If necessary, refill the oil level, taking into account that it should not go over the "B" mark.
7. Refit the dipstick.

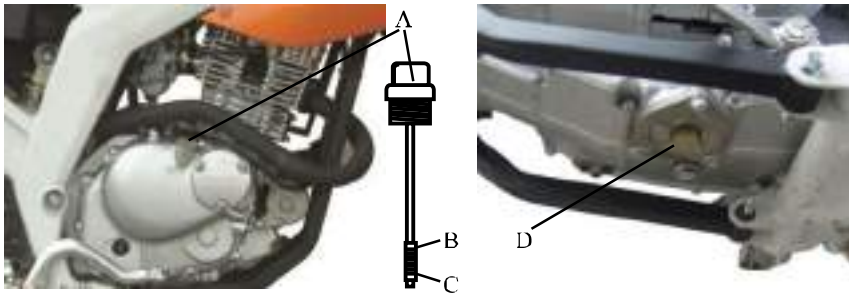

Replace the engine oil and clean the filter element.

To ensure complete oil drainage, the engine must be at normal temperature of operation.

Do the following operations:

1. Keep the vehicle in an upright position to the ground.
2. Place a container underneath the drain hole "D" to collect the used oil.
3. Remove the dipstick.
4. Loosen the oil drainage bung "D".
5. Check that the rubber O ring and the stopper ring of the drainage bung "D" are not damaged, and then tighten the bung at the torque of 20N-m
6. Add clean oil to the engine.
7. Tighten the dipstick, then start the engine letting it idle for at least 2 or 3 minutes.
8. Stop the engine and check if the oil level is at reference mark "B".

Warning

Work with caution paying attention to both the hot engine and hot used oil.

Used oil contains substances that are extremely harmful to the environment. It must be disposed of in an appropriate way. Most local authority refuse collection points have waste oil disposal.

Warning

The used oil can cause cancer to the skin. Because of this, avoid contact for prolonged periods. Although this is unlikely, unless you handle used oil on a daily basis, it is advisable to thoroughly wash your hands with soap and water as soon as possible

Battery

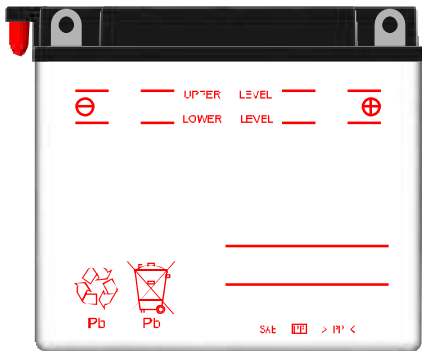

① battery

The battery is located under the seat. This battery is sealed type and requires no maintenance such as fluid level and gravity.

Spark Plug

Use a small metal brush or cleaner to remove the carbon deposits at the first 1000km or every 3000km lately. Readjust the spark plug gap with a spark plug gap thickness gauge to keep it 0.6~0.8mm. After every 6000km, the spark plug should be replaced.

Whenever you remove the carbon deposits, be sure to observe the colour of the spark plugs porcelain tip. The colour can tell you whether or not your motorcycle is running at it's optimum. If the spark plug is very black,

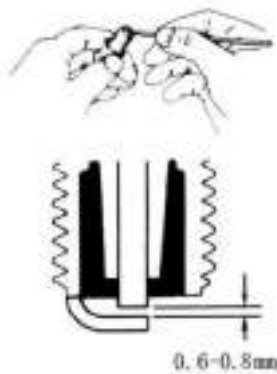

or almost pale white tan, your engine requires tuning. The spark plug should be a tan biscuit colour.

 **Caution**

- ◇ Don't tighten the spark plug too tightly or cross-thread it in order not to damage the cylinder head. Do not allow contamination to enter the engine through spark plug hole.
- ◇ The standard spark plug for this motorcycle has been carefully selected to meet the vast majority of all operation ranges. If you feel the environment of operation differs and a different spark plug should be used, it is best to consult the dealer before selecting an alternate plug or heat range. The selection of an improper spark plug can lead to severe engine damage.

Air Filter

The air filter element used in this motorcycle is a polyurethane foam element. If the filter element has become clogged with dust, intake resistance will increase with a resultant decrease in power output and increase in fuel consumption due to a richer mixture. Check and clean the air filter element according to the following procedure.

1. Remove the two screws.
2. Remove the two fixing slippers by sliding them rearward.
3. Remove the air filter cover.
4. Remove the filter element.

Washing the Air Filter Element

Wash the air filter element as follows:

1. Fill a washing pan with nonflammable cleaning solvent. Immerse the filter element in the solvent and wash it clean.
2. Squeeze the solvent off the washed filter element by pressing it between the palms of both hands. Do not twist and wring the filter element.
3. Immerse the filter element in a pool of filter oil and squeeze the oil off the filter element to make it slightly wet with the oil.
4. Reinstall the cleaned air filter element in reverse order of removal. Be absolutely sure that the filter element is securely in position and is sealed properly.

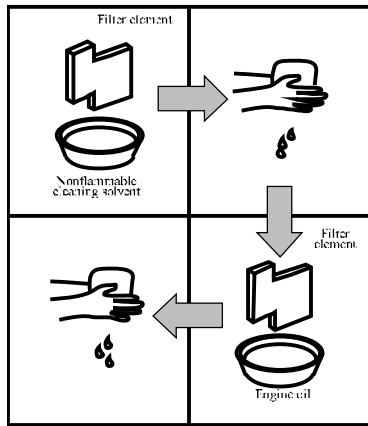

⚠Caution

- ◇ Before and during the cleaning operation, carefully examine the air filter element for any tears in the material. A torn filter element must be replaced with a new one.
- ◇ If driving under dusty conditions, the filter element must be cleaned more frequently.
- ◇ NEVER OPERATE THE ENGINE WITHOUT THE FILTER ELEMENT. Operating the engine without the filter element will increase engine wear. Always be sure that the filter element is in excellent operational condition at all times. The life of the engine depends largely on this single component.

Carburetor

The carburetor is set in the factory for optimum running. Do not attempt to alter its setting. There are two items of adjustment, however, you can adjust: engine idle speed and throttle cable play. Adjust the carburetor idle speed and throttle cable play periodically.

Engine Idle Speed Adjustment

1. Start up the engine and warm it up.
2. After engine warms up, turn the throttle stop screw in or out so that the engine may run at 1700~1900rpm.

If you have a tachometer, you can do this adjustment by referring to the procedures described above. The engine idle speed should be adjusted after the engine warms up.

Throttle Cable Adjustment

1. Loosen the lock nut.

2. Adjust the cable slack by turning the adjuster in or out to obtain the correct slack of 0.5~1.0mm.
3. After adjusting the slack, tighten the lock nut.

Tyres

Check the tyre inflation pressure and tyre tread condition. For maximum safety and good tyre life, the tyre pressures should be inspected more often.

Tyre Pressure

Insufficient air pressure in the tyres not only hastens tyre wear but also seriously affects the stability of the motorcycle. Under inflated tyres make smooth cornering difficult and over inflated tyres decrease the amount of tyre in contact with the ground, which can lead to slides and loss of control. Be sure that the tyre pressure is within the specified limits at all times. Tyre pressure should only be adjusted when the tyres are cold.

Cold inflation tyre pressure

Front Wheel	26psi
Rear Wheel	33psi

Caution

Tyre inflation pressures and the general tyre conditions are extremely important to the proper performance and safety of the motorcycle. Check your tyres frequently for both wear and inflation pressures

Tyre Tread Condition

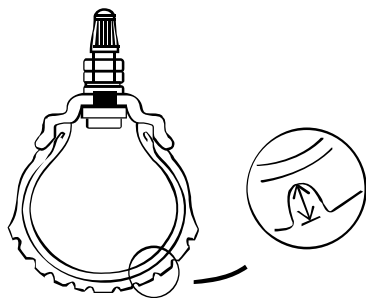

Operating the motorcycle with excessively worn tyres will decrease riding stability and can lead to loss of control. It is recommended that a tyre be replaced when the remaining depth of tyre tread becomes 1.6mm or less.

⚠ Caution

The use of a tyre size other than standard may cause instability.

Brake circuits

The front brake cylinder is located on the handlebar, near the throttle grip.

The Rear brake cylinder is located behind the rear brake pedal.

Follow the steps indicated in this procedure:

1. Keep the vehicle in vertical position with the handlebar centered.
2. The fluid level lowers when brake pads are worn. When the level is below than the minimum, refer to the nearest dealer to service the brake system.

Refilling the fluid

We advise against DIY brake maintenance and encourage you to check levels etc regularly

Use only the specified brake fluid DOT 4

Follow the next operations:

1. Keep the vehicle in vertical position with the handlebar centered.
2. Remove the cylinder cap by loosening the securing bolts.
3. Fill up the fluid at correct level, use only the specified fluid.
4. Install the cover in the reverse order of removal.

⚠ Warning

Brake fluid can be dangerous. In case of accidental contact, clean immediately with water all affected areas.

⚠ Caution

Make sure there is no leakage in the circuit and check that the hoses and the unions are not damaged and also they should not be twisted.

⚠ Warning

The adjustment of the brake master cylinder has been done at the factory; for service go to your nearest dealer.

⚠ Caution

The brake circuit fluid is highly corrosive, avoid contact with the body, painted parts and and/or any plastic parts.

 **Warning**

The brake circuit fluid is hygroscopic (it absorbs the moisture). If the moisture of the brake fluid is higher than its specified value, the brakes will not work properly.

Under normal weather conditions, the brake fluid must be replaced every 2 years. For this service go to your nearest dealer.

Fuel Hose

Replace the fuel hoses every four years.

Fuse

The fuse is located next to the battery. If there is any electrical system failure, first check the fuse. In the case the fuse blows, there is a 10A spare fuse.

 **Caution**

Always be sure to replace the blown fuse with the correct amperage fuse. Never use substitute, for example aluminum foil or wire, to replace a blown fuse. If the spare fuse installed blows in a short period of time, it means that you could have a major electrical problem. You should consult the dealer or a qualified service mechanic immediately.

Troubleshooting

If the engine refuses to start, perform the following inspections to determine the cause.

1. Is there enough fuel in the fuel tank?
2. Is there fuel reaching the carburetor from the fuel tank?
3. Loosen the carburetor drain plug and drain the fuel in the carburetor. Refit the drain plug.
4. Depress the kick-starter lever several times.
5. Loosen the drain plug and check that the fuel is in the carburetor.
6. If it has been determined that fuel is reaching the carburetor, the ignition system should be checked next.

Caution

Do not allow the fuel to spill. Do not allow any fuel to come in contact with the hot engine or exhaust system. Do not smoke or work near naked flames or a high heat source.

1. Remove the spark plug and reattach it to the spark plug lead.
2. While holding the spark plug firmly against the engine with an insulated tool, crank the engine with the ignition switch in ON position. If the ignition system is operating properly, a blue spark should jump across the spark plug gap. If there is no spark, consult the dealer for repairs.

Caution

Do not hold the spark plug close to the open spark plug hole in the cylinder head as gasoline vapor inside the cylinder could be ignited, creating a fire hazard.

To reduce the chance of electrical shock, hold the metal shell of the spark plug against an unpainted metal portion of the engine. Due to the possibility of electrical shock, anyone with a heart condition or pacemaker should avoid this check.

Engine Stalling

1. Check the fuel supply in the fuel tank.
2. Check the ignition system for intermittent spark.
3. Check the engine idle speed.

Caution

It is best to consult the dealer before attempting to troubleshoot any problem. If the machine is still within the warranty, then the dealer should definitely be consulted before you attempt any repairs on the machine. Tampering with the machine by yourself while in warranty may affect your warranty.

Storage Procedures

If the motorcycle is to be left unused for extended period of time for winter storage or any other reason, the machine needs special attention. For this reason, we recommend that you trust this maintenance work to a dealer. If you need to service the machine for storage yourself, follow the general guidelines below.

Motorcycle

Place the motorcycle on its stand and thoroughly clean the entire motorcycle.

Fuel

Fill the fuel tank to the top with fuel mixed with the amount of petrol stabiliser, recommended by the stabiliser manufacturer.

Drain the carburetor or run the engine for a few minutes until the stabilised petrol fills the carburetor.

Battery

Remove the battery from the motorcycle.

Clean the outside of the battery with mild detergent and remove any corrosion from the terminals and wiring harness connections.

Store the battery in a room above freezing.

Tyre

Inflate the tyres to the normal specifications.

External

Spray all vinyl and rubber parts with rubber preservative.

Spray the unpainted surfaces with rust preventative.

Coat the painted surfaces with car wax.

Procedure for Returning to Service

Clean the entire motorcycle.

Reinstall the battery.

Remove the spark plug. Turn the engine a few times by depressing the starter button.

Reinstall the spark plug.

Adjust the pressure of tyres as described in the tyre section.

Lubricate all places as instructed in this manual.

Do the INSPECTION BEFORE RIDING as listed in this manual.

Specifications

Item	Parameter
Model	DFE125CBF
Overall size(mm)	2120×840×1120
Wheel base(mm)	1400
Net weight(kg)	115
Max loading weight(kg)	150
Fuel tank capability (L)	8.5
Engine model	FMI
Engine type	Single cylinder , four-stroke, air cooled
Bore×stroke(mm)	57.0×48.8
Total displacement(ml)	124
Compression ration	9.5:1
Max net power, rate (kW/r/min)	7.5/8500
Max net torque, rate (Nm/r/min)	8.5/8000
Min-fuel consumption(g/km.h)	376
Start mode	Electric/Kick
Lubrication method	disconnected lubrication
Lubrication oil mode	SAE 10W/40
Fuel type	Octane rating of 90 or higher
Ignition mode	C.D.I

Tire type	
Front tire size	110/70-17(optional:3.00-21)
Rear tire size	130/70-17(optional:4.10-18)
Inflation:	
Front	26psi
Rear	33psi
Front brake	Disc brake
Rear brake	Disc brake
Spark plug	NGK A7RTC
Head lamp	12V 35W/35W
Turning lamp	12V LED
Tail lamp/ Brake lamp	12V LED
Instrument indicator	12V 3W
Battery capacity	12V 6Ah
Fuse	10A
Horn	12V 1.5A 90-100dB(A)
Brake distance	≤ 7m
Max noise	≤ 78dB(A)
Max speed (km/h)	100

