

**ENG**

**USER MANUAL**

<https://www.motorcycle-manual.com/>



**X & i**  
mod.# U 03

## INTRODUCTION

Thanks for your purchasing of this vehicle. This model is designed for safety, built for durability, and perfected for daily street use. The unique vehicle design, enrich of stylish and peronality, represents your outstanding taste and favor to pursue the state of the art living attitude.

This manual describes the correct usage of this motorcycle including safety riding, simple inspection methods and so on. For a more comfortable and safety riding, please read this manual carefully. If any questions concerning the operation or maintenance of your vehicle, please consult a dealer.

# IMPORTANT MANUAL INFORMATION

In this manual with some important information is distinguished by the following notations:

## **▲ WARNING**

It is **WARNING** instructions that need to follow, failure of follow could be end in result severe injury or lead to death to the operator.

## **CAUTION**

A **CAUTION** indicates with special precautions to avoid damage to the vehicle.  
A **CAUTION** indicates important information in this manual.

## **CAUTION**

- Please always put this manual with vehicle for rider maintenance/ dealer tracking of service records even if vehicle is being sold.
- This manual contains the most of the vehicle information, however, the maker will continually improve it's product design and quality that lead to difference between the manual and vehicle . If you have any questions concerning this manual, please consult your dealer.

## **▲ WARNING**

**FOR YOUR OWN SAFETY, PLEASE READ THIS MANUAL CAREFULLY BEFORE OPERATION THIS VEHICLE. ONLY OPERATE THE VEHICLE UNTIL YOU HAVE COMPLETELY AWARE OF ADEQUATE KNOWLEDGE OF CONTROLS AND OPERATION FEATURE AND YOU HAVE BEEN TRAINED IN SAFE AND PROPER RIDING TECHNIQUES. PERIODIC INSPECTIONS, WELL MAINTENANCE AND GOOD RIDING SKILLS, WILL ENSURE YOUR SAFETY RIDING AND INCREASE THE PRODUCT RELIABILITY OF THIS VEHICLE.**

\*Product and specifications are subject to change without notice.

**IMPORTANT MANUAL INFORMATION**



Dealer label here

# TABLE OF CONTENTS

<b>INTRODUCTION</b> .....	1	Engine oil cap.....	17	Throttle cable free play adjustment.....	29
<b>IMPORTANT MANUAL INFORMATION</b> .....	2	Catalytic converter.....	17	Clutch free play.....	30
<b>TABLE OF CONTENTS</b> .....	4	Side stand.....	18	Clutch free play adjustment.....	30
<b>SAFETY INFORMATION</b> .....	6	<b>PRE-OPERATION CHECKS</b> .....	19	Tires.....	30
Safe riding.....	6	Pre-operation check list.....	20	Tire air pressure.....	30
Protective clothing.....	6	<b>OPERATION AND IMPORTANT</b>		Tire inspection.....	31
Modifications.....	7	<b>RIDING POINTS</b> .....	21	Rims.....	32
Loading and accessories.....	7	Starting the engine.....	21	Brake free play.....	32
Accessories.....	7	Starting off.....	21	Front brake.....	32
Gasoline and exhaust gas.....	8	Shifting and riding.....	22	Rear brake.....	32
Other safe-riding points.....	8	Acceleration / Deceleration.....	22	Brake pedal free play.....	32
Location of label.....	9	Braking.....	22	Brake pads.....	33
<b>DESCRIPTION OF THE VEHICLE</b> .....	10	Stop the Engine / Parking.....	22	Brake fluid.....	33
Side view.....	10	Engine break in.....	23	Changing the brake fluid.....	34
Controls and instruments.....	11	<b>PERIODIC MAINTENANCE AND</b>		Cables.....	34
<b>INSTRUMENT AND CONTROL</b>		<b>MINOR REPAIR</b> .....	25	Throttle grip and cable.....	34
<b>FUNCTIONS</b> .....	12	Owner's tool kit.....	25	Lubricating the brake lever and brake	
Main switch.....	12	Spark plug.....	25	pedal.....	34
Dashboard unit.....	12	Check the spark plug.....	26	Side stand.....	35
Handlebar switches - Left.....	13	Engine oil.....	27	Front fork.....	35
Handlebar switches - Right.....	14	Check engine oil.....	27	Steering.....	35
Brake lever.....	15	Oil change.....	28	Wheel bearings.....	36
Brake pedal.....	15	Fuel filter.....	28	Drive chain.....	36
Gear shift pedal.....	15	Air filter.....	28	Tensioning the chain drive.....	36
Fuel tank.....	16	Replace the air filter.....	28	Shock absorber.....	37
Remove the fuel tank cap (1).....	16	Carburetor.....	29	Adjust the shock absorber.....	37
Install the fuel tank cap (1).....	16	Idling speed.....	29	Battery.....	37
Fuel.....	16	Throttle cable free play.....	29	Charge the battery.....	38
				Store the battery.....	38

# TABLE OF CONTENTS

Fuse .....	38	Service record.....	52
Replacing the fuse.....	38	<b>SPACE FOR NOTES</b> .....	<b>53</b>
Lighting.....	39		
Headlight.....	39		
Turn signal light - Front.....	40		
Turn signal light - Rear.....	40		
Tail light / Brake light.....	40		
License plate light.....	40		
<b>TROUBLESHOOTING</b> .....	<b>41</b>		
Troubleshooting chart.....	42		
<b>CLEAN AND STORAGE</b> .....	<b>43</b>		
Clean the vehicle.....	43		
Before cleaning.....	43		
Cleaning after normal use.....	43		
Cleaning after riding in the rain, near the sea or on salt-sprayed roads.....	43		
After cleaning.....	43		
Storage.....	44		
Short-term (for a few days).....	44		
Long-term (for weeks).....	44		
<b>SPECIFICATIONS</b> .....	<b>45</b>		
<b>CONSUMER INFORMATION</b> .....	<b>48</b>		
Vehicle identification number (VIN).....	48		
<b>WARRANTY INFORMATION</b> .....	<b>49</b>		
<b>SERVICE AND MAINTENANCE</b> .....	<b>50</b>		
Important information.....	50		
Maintenance schedule.....	51		

# SAFETY INFORMATION

THIS VEHICLE ARE TWO WHEEL SINGLE TRACK VEHICLES. THE USE OF SAVETY AND OPERATION MAY IN DIFFERENT RESULT BY THE USE OF PROPER RIDING TECHNIQUES OF THE OPERATOR. TO REMIND OF OPERATOR, WHO SHOULD KNOW THE FOLLOWING REQUIREMENTS BEFORE RIDING.

HE OR SHE SHOULD:

- WELL TRAINED AND FAMILIAR TO ALL THE ASPECTS OF Vehicle OPERATION.
- FULLY READ AND AWARE OF MAINTENANCE REQUIREMENTS THAT NOTED IN THIS OWNER'S MANUAL.
- OBTAIN QUALIFIED TRAINING & LEGAL LICENSE FOR OPERATION OF THIS VEHICLE.
- WELL AND PROFESSIONAL MAINTENANCE SERVICE FOR OPERATOR AND CERTIFIED REPAIR SHOP/DEALER TO ACQUIRE GOOD MECHANICAL CONDITIONS OF VEHICLE.

## **Safe riding**

- Always pre-check your vehicle before riding is key point to prevent an accident.
- Please follow the maximum loads limited of operator and passenger.
- Most of accident on the motorists is caused by automobile driver who "failure to recognize out the vehicle" and caused mobile/vehicle accidents. Therefore, to make yourself conspicuous appear to public will be very effective in reducing the change of this kind of accidents.

## **Therefore:**

- Wear a brightly colored and protective clothes/Jacket
- Operate the turning signals before turning and slow down the Speed when approaching and pass through the intersection
- Keep proper distance with other Motorists, and let them aware of your location
- Know your skills and limits

- Never lend your vehicle to others who not qualified for riding
- Always follow the legal speed limit on the vehicle and traffic law
- The posture of the operator and passenger is important for proper control, properly riding posture can Keep vehicle in balance while riding.
- Operator should sit up-right with two hand hold on handle bar, foot on floorboard while driving.
- Passenger should make sure that he/she can firmly hold on grip or operator with foot step on footrest.
- Driving after Alcohol drink or other illegal drugs is strictly prohibited.
- This vehicle is designed for onroad use only. It is not suitable for off-road use.

## **Protective clothing**

Properly clothing yourself will keep you safety from potential accidents:

- Always wear an approved helmet.
- With face shield to protect your eye from dust and rain drop.

- The wear of proper jacket, shoes, groves etc., can be better protection, reducing the degree of injury from un-expected accident.
- Never wear loose-fitting clothes, otherwise they could catch on the control levers or wheels and cause injury or an accident.
- Never touch the engine or exhaust system during or after operation. They become very hot and can cause burns. Always wear protective clothing that covers your legs, ankles, and feet.

## **Modifications**

Modifications made to this vehicle that not approved by maker, or the removal of original equipment, may let vehicle unsafe for use and cause severe personal injury. Modifications may also make your vehicle illegal touse.

## **Loading and accessories**

Adding accessories or cargo to your vehicle may cause the different on the weight distribution of vehicle and in-

fluence on the steering & balance. It may cause possibility of an accident, please extremely caution and follow below limitation when you equipped with accessories. Below are some general or accessories. Here are some guidelines to follow if loading cargo or adding accessories to your vehicle.

## **Loading**

The total weight of the operator, passenger (when allowed), accessories and cargo must not exceed the maximum load limit.

**Maximum load  
(not include the vehicle):  
150kg**

When loading within this weight limit, keep the following in mind:

- Cargo and accessory weight should be kept as low and close to the vehicle as possible. Make sure to distribute the weight as evenly as possible on both sides of the vehicle to

- minimize imbalance or instability.
- Make sure that accessories and cargo are securely attached to vehicle before riding
- Never attach any large or heavy items to the handlebar, front fork, or front fender. Such items can create unstable handling or a slow steering response.

## **Accessories**

Genuine accessories have been specifically designed for use on this vehicle. If need, please contact with dealer for detail. Since the maker can not test all other accessories, you must personally be responsible for the proper selection, installation and use of non-OEM accessories.

Keep the following guidelines in mind, when mounting accessories.

- Never install accessories or carry cargo that would influence on the ground clearance, limit suspension travel, steering, or obscure lights or turning lights, reflectors.



# SAFETY INFORMATION

- Accessories on the handle bar/front suspension area will cause bad influence on steering the vehicle. If you will install accessories, please keep it as light in weight and not interfere on steering the vehicle. This vehicle is for On-Road transportation purpose only, please do not install any of extended cargo carrier as sulky, that will make vehicle unstable in cross winds and vehicle turns.
  - While equip with electrical accessories, please consult with qualified stores, to make sure such items will not exceed the capacity of the vehicle's electrical system. Unproper install of such items may cause a dangerous loss of lights, lower engine power or even damage the vehicle.
- Gasoline and exhaust gas**
- GASOLINE IS HIGHLY FLAMMABLE:
    - Always turn the engine off when refueling.
  - Take care not to spill any gasoline on the engine (hot) or exhaust system when refueling.
  - Do not smoke or use Mobile phone while re-fueling.
  - Never start the engine or let it run for any length of time in a closed area. The exhaust fumes are poisonous and may cause loss of consciousness and death within a short time.
  - Always turn the engine off before leaving the vehicle and remove the key from the main switch. When parking the vehicle, please note the following:
    - The engine and exhaust system remain hot, therefore, park the vehicle in a place where pedestrians or children are not likely to touch these hot areas.
    - Do not park the vehicle on a slope or soft ground, otherwise it may fall over.
    - Do not lay your vehicle to near flammable place.
  - In case of swallow any gasoline, or gasoline get into your eyes, please see your doctor immediately. Keep away the gasoline to your skin and water.
- OTHER SAFE-RIDING POINTS**
- Turn the signal before making turns.
  - When raining or across on run on the wet road, Iron Plates, keep your speed low, slightly using braking to avoid slipping or even fall down.
  - Be careful when passing parked cars. A driver might not see you and open a door in your path.

# SAFETY INFORMATION

## LOCATION OF LABEL

1. Anti-tampering label

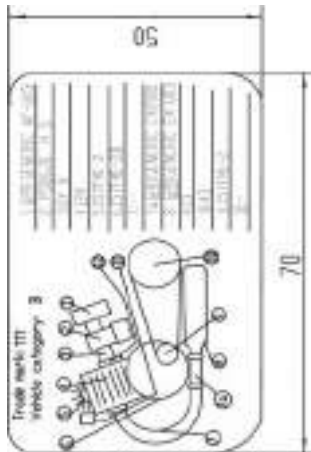
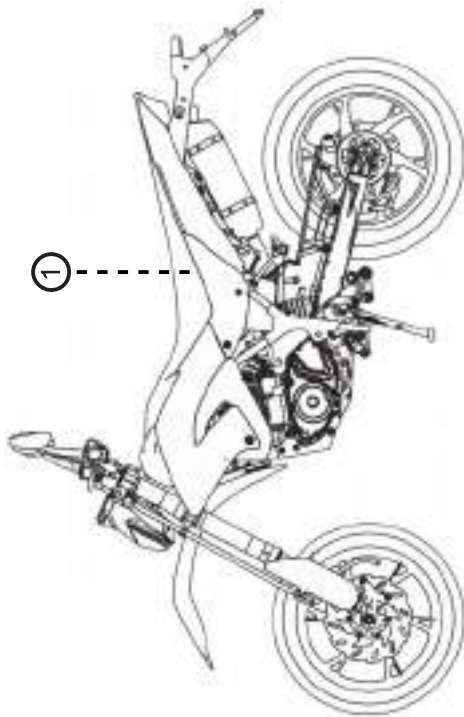

Symbol image

## DESCRIPTION OF THE VEHICLE

### SIDE VIEW

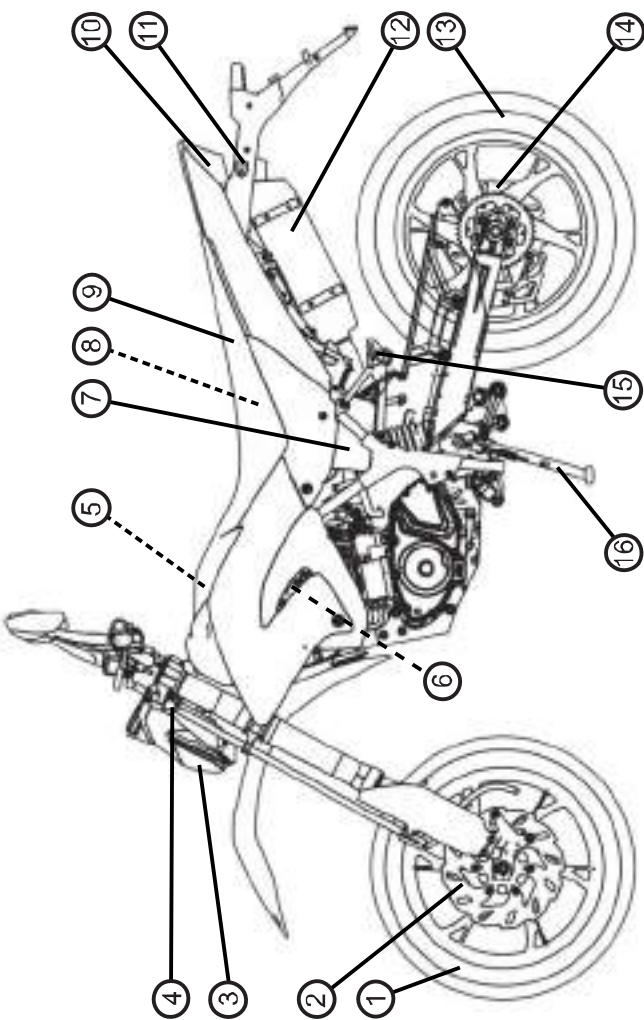

1. Wheel - Front
2. Brake disc - Front
3. Headlight
4. Turn signal light - Front
5. Fuel tank cap
6. Spark plug
7. Air filter
8. Battery
9. Seat
10. Tail light / Brake light
11. Turn signal light - Rear
12. Muffler
13. Wheel - Rear
14. Brake disc - Rear
15. Pedal
16. Side stand

# DESCRIPTION OF THE VEHICLE

## CONTROLS AND INSTRUMENTS

1. Handlebar switches - Left
2. Clutch lever
3. Shift pedal
4. Dashboard unit
5. Handlebar switches - Right
6. Brake lever - Front brake
7. Throttle grip
8. Brake pedal - Rear brake
9. Main switch

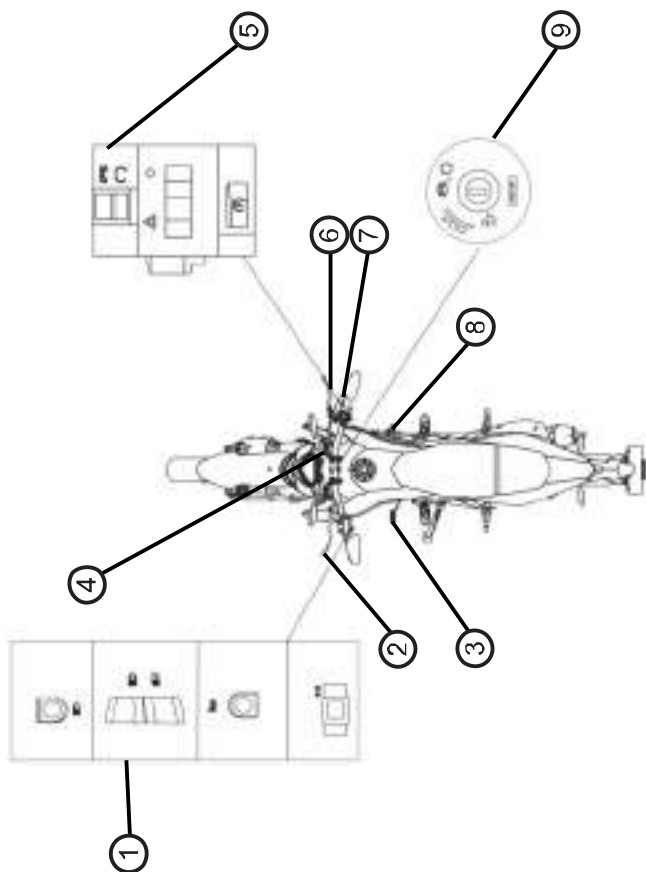

# INSTRUMENT AND CONTROL FUNCTIONS

## MAIN SWITCH



The main switch controls the ignition and lighting systems, and also used to lock the steering. The various positions are described as below.

### On

All electrical circuits are supplied with power, the engine can be started. The key cannot be removed.

### Off

All electrical systems are off. The key can be removed.

## Steering lock

The steering is locked, and all electrical systems are off. The key can be removed.

### Lock the steering

1. Turn the handlebar fully to the left.
2. Insert the key into the main switch.
3. Turn the key while you apply pressure to it, counterclockwise in the position. If the lock does not engage immediately, move the handlebars back and forth slightly.
4. Remove the key.

### Unlock the steering

1. Insert the key into the main switch.
2. Turn the key clockwise to the position. If the lock does not engage immediately, move the handlebars back and forth slightly.

### WARNING

Never turn the key to or , while the vehicle is moving, otherwise the electrical systems will be switched off, which may result in loss of con-

trol or an accident. Make sure that the vehicle is stopped before turning the key.

## DASHBOARD UNIT

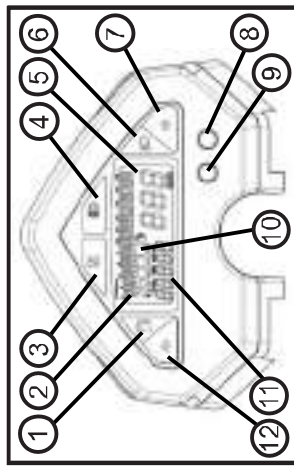

1. Fuel warning indicator
2. Rev counter
3. Neutral indicator lamp N
4. High beam indicator lamp
5. Speedometer
6. Low beam indicator lamp
7. Turn signal indicator light - Right
8. Function button 1
9. Function button 2

# INSTRUMENT AND CONTROL FUNCTIONS

10. Fuel gauge 

11. Odometer

12. Turn signal indicator light - Left 

**Speedometer**

The dashboard unit is equipped with a speedometer.

The speedometer shows the riding speed.

**Fuel warning indicator** 

The fuel warning indicator shows if you have only little fuel in the tank. Refuel immediately.

## CAUTION

Be take care not let the fuel tank to fully empty it-self, that cause engine can not run it-self anymore.

**Rev counter**

Displays the engine speed in RPM.

**Neutral indicator lamp (N)**

Lights up whenever neutral (N) is selected.

**High beam indicator lamp** 

Lights up whenever high beam is switched on.

**Odometer**

The dashboard unit is equipped with an odometer.

The odometer shows the total distance traveled.

**Turn signal indicator light - Left** 

This indicator light flashes when the turn signal switch is pushed to the left.

**Function button 1**

When you press this button you can shift from total meter to trip meter.

**Function button 2**

When you press this button you can shift from km to mile.

**Fuel gauge** 

Displays how much fuel remains in the fuel tank. The fuel gauge indicates the amount of fuel in the fuel tank.

**HANDLEBAR SWITCHES - LEFT**



# INSTRUMENT AND CONTROL FUNCTIONS

1. Passing beam switch
2. Choke lever
3. High / Low beam switch
4. Turn signal switch
5. Horn switch

## Passing beam switch

As long as the button is pressed will light the high beam.

## Choke lever

The operation of the choke lever facilitates the ignition and start of the vehicle while the engine is cold.



### CAUTION

Do not forget to give back the choke lever to the starting position after the engine is warmed up.

## High / Low beam switch

Set this switch to  for the high beam and to  for the low beam.

## Turn signal switch

To signal a right-hand turn, push this switch to . To signal a left-hand turn, push this switch to . When released the switch returns to the center position. To cancel the turn signal lights, push the switch in after it has returned to the center position.



## Horn switch

Press this  switch to sound the horn.

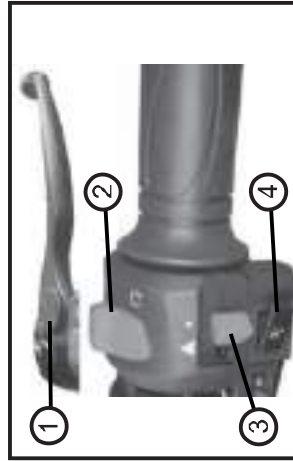
## HANDLEBAR SWITCHES - RIGHT





1. Lever adjustment
2. Engine - ON  / OFF 

3. Warning light switch  / 
4. Electro starter switch 

## Lever adjustment

You can adjust the lever distance to suit your needs. Push the lever forward slightly and turn the screw in the desired positions of the four, this must be on the lever opposite the arrow symbol. Position 1 is the longest and the shortest distance position 4.

## Engine - ON / OFF

The power switch is "ON" and ignition switch is at  position, at the meantime, grip the brake, the engine can be started. And press engine off switch at  position, the engine is will be off.

## Warning light switch /

By changing the switch position you can switch on  or off  the warning light.

# INSTRUMENT AND CONTROL FUNCTIONS

## Electro start switch

Push this switch  (pull the brake lever at same time) to the start the engine.

### **CAUTION**

Before starting the vehicle check the notes in the user manual.

## BRAKE PEDAL

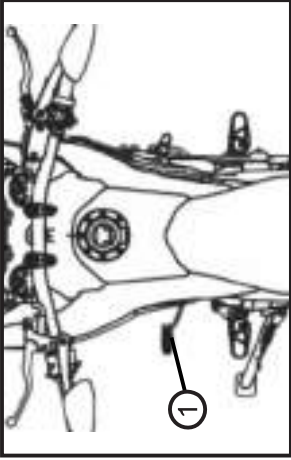

## BRAKE LEVER



The front brake lever is located on the right handlebar grip. To apply the front brake, pull this lever toward the handlebar grip.

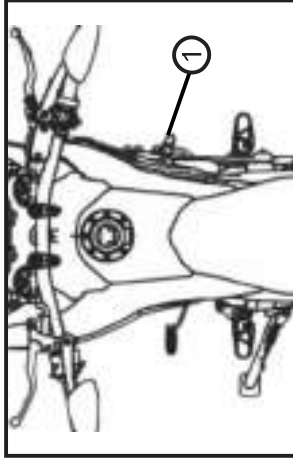

The brake pedal (1) is located on the right-hand side of the vehicle and operates the rear brake. Familiarise yourself with how it works before you ride the vehicle on public roads. Novices and returning riders are recommended to take a riding techniques course.

## GEAR SHIFT PEDAL

The gear shift pedal (1) is located on the left side of the vehicle. The vehicle is equipped with a 5-speed manual transmission.

Before commissioning, familiarize yourself with the handling of such a transmission, otherwise serious damage and or injuries could be provoked.

### **CAUTION**

Never attempt to change gear without releasing the clutch. Novices and returning riders are recommended to take a riding techniques course.





### Remove the fuel tank cap (1)

1. Open the lock cover (2).
2. Put in the key into the lock.
3. Turn the cap with the key a quarter turn clockwise.
4. Open the fuel tank cap.

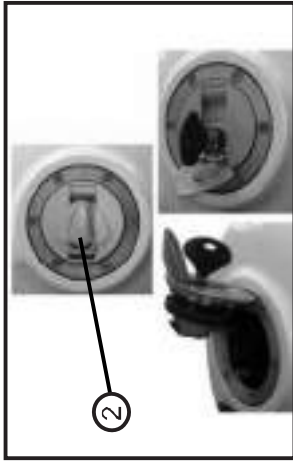

### FUEL TANK

The fuel tank cap (1) is located on the upper side of the vehicle.

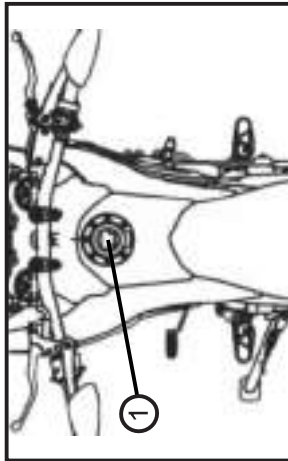

### FUEL

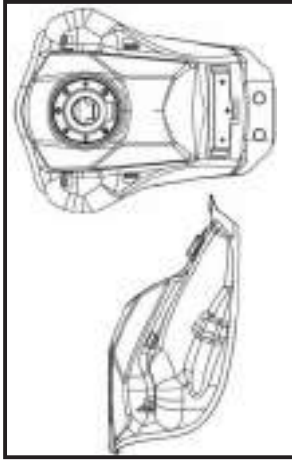

Make sure that there is sufficient fuel in the tank. Fill the fuel tank to the bottom of the filler tube as shown.

#### **WARNING**

- Do not overfill the fuel tank, otherwise it may overflow when the fuel warms up and expands.
- Avoid spilling fuel on the hot engine.

#### **CAUTION**

Immediately wipe off spilled fuel with a clean, dry, soft cloth, since fuel may damage the painted surfaces or plastic parts.

### Install the fuel tank cap (1)

1. Close the fuel tank cap.
2. Turn it with the key 1/4 turn counterclockwise until it locks in place.
3. Remove the key.
4. Close the lock cover.

#### **CAUTION**

Make sure that the fuel tank cap is properly closed and locked before riding.

# INSTRUMENT AND CONTROL FUNCTIONS

Regular unleaded gasoline only.

Recommended fuel: 95 oct  
7.0 l +/- 0.3 l

!!CAUTION!!

BIOETHANOL E10 IS NOT SUITABLE

## ⚠ WARNING

At each refuelling you have to control the engine oil.

## ⚠ CAUTION

Make sure that the engine oil cap (1) is properly installed before riding the vehicle.

## ENGINE OIL CAP

The engine oil cap (1) is located on the right side of the vehicle.



## Capacity:

Full: 1.4 l / Change: 1.3 l  
4-stroke engine oil

Recommended engine oil:  
Castrol Power 1 Racing 4T

## CATALYTIC CONVERTER

This model is equipped with a catalytic converter in the exhaust system.

## ⚠ WARNING

The exhaust system is hot after operation. Make sure that the exhaust sys-

tem has cooled down before doing any maintenance work.

## ⚠ CAUTION

The following precautions must be observed to prevent a fire hazard or other damages.

- Use only unleaded gasoline. The use of leaded gasoline will cause unrepairable damage to the catalytic converter.
- Never park the vehicle near possible fire hazards such as grass or other materials that easily burn.
- Do not allow the engine to idle too long.

## INSTRUMENT AND CONTROL FUNCTIONS

### SIDE STAND

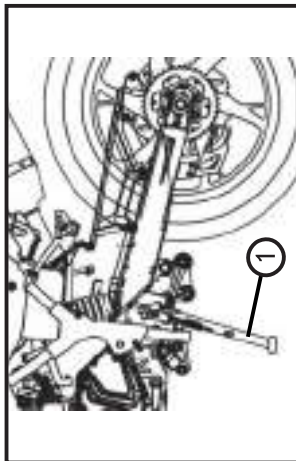

The side stand (1) is located on the left side of the vehicle. Release the side stand by using your feet to step on the bracket of side stand to up-right position to stand the vehicle.

#### **CAUTION**

- The side stand with auto-rebound system. Make sure your vehicle have been park well are stable enough to stand the vehicle.
- Please avoid to use side stand to park the vehicle on the slope, soft land or un-flat ground.

## PRE-OPERATION CHECKS

The condition of a vehicle is the owner's responsibility. The operator should check the vehicle by simple but thorough inspection, to make sure of vehicle condition, quick inspect some key and important parts, to prevent the vehicle from serious consequence/accident. Please carefully check the following points before each ride.

### **CAUTION**

Pre-operation checks should be made each time the vehicle is used. Such an inspection can be accomplished in a very short time; and the added safety it assures is more than worth the time involved.

### **⚠ WARNING**

**If any item in the Pre-operation check list is not working properly, have it inspected and repaired before operating the vehicle. If failed to be corrected by yourself, please turn to repair shop immediately. If failed to be corrected by yourself, please turn to repair shop immediately.**

# PRE-OPERATION CHECKS

## PRE-OPERATION CHECK LIST

CHECKPOINT	TO VERIFY
Fuel	<ul style="list-style-type: none"> <li>• Check fuel level in fuel tank.</li> <li>• Refuel if necessary.</li> <li>• Check fuel line for leakage.</li> </ul>
Engine oil	<ul style="list-style-type: none"> <li>• Check oil level in oil tank.</li> <li>• If necessary, add recommended oil to specified level.</li> <li>• Check vehicle for oil leakage.</li> </ul>
Final transmission oil	<ul style="list-style-type: none"> <li>• Check vehicle for oil leakage.</li> </ul>
Front brake	<ul style="list-style-type: none"> <li>• Check operation.</li> <li>• If soft or spongy, have dealer bleed hydraulic system.</li> <li>• Check brake pads for wear.</li> <li>• Replace if necessary.</li> <li>• Check fluid level in reservoir.</li> <li>• If necessary, add recommended brake fluid to specified level.</li> <li>• Check hydraulic system for leakage.</li> </ul>
Rear brake	<ul style="list-style-type: none"> <li>• Check operation.</li> <li>• If soft or spongy, have dealer bleed hydraulic system.</li> <li>• Check brake pads for wear.</li> <li>• Replace if necessary.</li> <li>• Check fluid level in reservoir.</li> <li>• If necessary, add recommended brake fluid to specified level.</li> <li>• Check hydraulic system for leakage.</li> </ul>
Throttle grip	<ul style="list-style-type: none"> <li>• Make sure that operation is smooth.</li> <li>• Check cable free play.</li> <li>• If necessary, have dealer adjust cable free play and lubricate cable and grip housing.</li> </ul>
Wheels and tires	<ul style="list-style-type: none"> <li>• Check for damage.</li> <li>• Check tire condition and tread depth.</li> <li>• Check air pressure.</li> </ul>
Brake levers	<ul style="list-style-type: none"> <li>• Make sure that operation is smooth. Lubricate lever pivoting points if necessary.</li> </ul>
Main stand	<ul style="list-style-type: none"> <li>• Make sure that operation is smooth. Lubricate pivot if necessary.</li> </ul>
Chassis fasteners	<ul style="list-style-type: none"> <li>• Make sure that all nuts, bolts and screws are properly tightened. Tighten if necessary.</li> </ul>
Instruments, lights, signals and switches	<ul style="list-style-type: none"> <li>• Check operation, correct if necessary</li> </ul>

# OPERATION AND IMPORTANT RIDING POINTS

## **⚠ WARNING**

- Before riding the vehicle, please make sure that you are fully familiar with all operating controls & their functions before riding. To consult a dealer shop if you not thoroughly understand.
- Please do not start the engine in a closed area, the exhaust air are poisonous, and inhaling them can cause loss of consciousness and even death in short time.

## STARTING THE ENGINE

### **CAUTION**

Note the point „Engine break in“ before you start to riding the vehicle.



1. Turn the key to ON  $\odot$ .
2. Insert the neutral gear.
3. Actuate the front or the rear brake.
4. Push the start switch button  $\text{Ⓢ}$  (1) for a few seconds.

### **CAUTION**

- Do not crank the engine more than 5 seconds on any one attempt.
- The engine starts immediately upon actuation of the starter, then wait a

few seconds before you try to start it again. Each starting process should be as short as possible in order to save battery and the starter.

## STARTING OFF

### **CAUTION**

Before starting off, allow the engine to warm up to avoid damages.

1. Sit astride the seat, and then adjust the rear view mirrors.
2. Switch the turn signal on to the direction you wish to turn.
  1. Pull the clutch lever
  2. Shift the engine to the first gear
  3. Check for oncoming traffic.
  4. Slowly release the clutch lever and open the throttle at the same time.
  5. Switch the turn signal off.

## SHIFTING AND RIDING

### a) Shifting gears upwards

1. Release the throttle
2. Pull the clutch lever
3. Lift the gear lever upwards to change to the higher gears.
4. Slowly release the clutch lever and open the throttle at the same time.

### b) Shifting gears downwards

1. Release the throttle
2. Operate the brakes and reduce the speed to a appropriate speed.
3. Pull the clutch lever
4. Lift the gear lever downwards to change to the lower gears.
5. Slowly release the clutch lever and open the throttle at the same time.

## ACCELERATION / DECELERATION

The speed can be adjusted by opening and closing the throttle. To increase the speed, turn the throttle grip in direction (a). To reduce the speed, turn the throttle grip in direction (b).

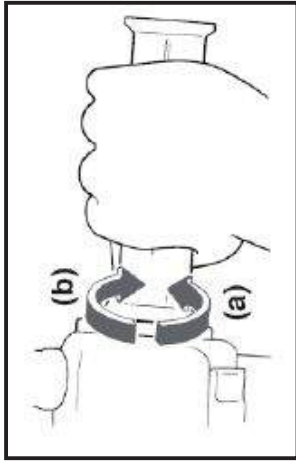

## ⚠ WARNING

- Avoid braking hard or suddenly, otherwise the vehicle may skid.
- Railroad crossings, streetcar rails, iron plates on road construction sites, and manhole covers become extremely slippery when wet. Therefore, slow down when approaching such areas and cross them with caution.
- Keep in mind that braking on a wet road is much more difficult.
- Ride slowly down a hill, as braking downhill can be very difficult.

## BRAKING

1. Release the throttle.
2. Apply the clutch lever gradually increasing the pressure.
3. Apply the front and rear brake at the same time.

## STOP THE ENGINE / PARKING

1. Reduce the throttle to 0 position.
2. Pull the clutch lever
3. Switch the gear to **N** - neutral
4. Operate the brakes
5. After the vehicle is stopped turn off the ignition.

## OPERATION AND IMPORTANT RIDING POINTS

6. Lower the side stand with your foot while holding the motorcycle upright. Remove the key from the main switch.

### **▲ WARNING**

Since the engine and exhaust system can become very hot, park in a place where pedestrians or children are not likely to touch them. Do not park on a slope or on soft ground, otherwise the vehicle may overturn.

### **ENGINE BREAK IN**

During the first 1000 km do not ride the vehicle over 75% of its maximum speed.

Avoid opening the accelerator completely and varies speed repeatedly over long distances.

After the first 1000 km increase speed gradually until reaching maximum performance.

### **CAUTION**

- The durability and the efficiency of your scooter depend strongly on the care received during the run-in period. The mechanisms of the mobile parts are mutually hardened and adapted.

- After better run-in is obtained not by riding slowly but softly and carefully. During this period, it is advisable to ride the vehicle at  $\frac{3}{4}$  of maximum performance. In the event that full acceleration is necessary (overtaking maneuvers, steep slopes, etc.) try to limit the time to a minimum.

- Gearbox oil must be changed once the first 1000 km are covered. Use the recommended oil type and specified quantity only.

The durability and the efficiency of your scooter depend strongly on the care received during the run-in period. The mechanisms of the mobile parts are mutually hardened and adapted.

After better run-in is obtained not by ri-

ding slowly but softly and carefully. During this period, it is advisable to ride the vehicle at  $\frac{3}{4}$  of maximum performance. In the event that full acceleration is necessary (overtaking maneuvers, steep slopes, etc.) try to limit the time to a minimum.

Gearbox oil must be changed once the first 1000 km are covered. Use the recommended oil type and specified quantity only.

To obtain optimum adjustment of mobile parts, a long life and better performance, it is necessary not to force the vehicle during the 1000 km.

The vehicle must have a suitable run-in period, during which the following precautions must be considered:

- After starting the engine, warm it up progressively, without maximum acceleration (we recommend not to exceed  $\frac{3}{4}$  of the throttle grip opening for 1st gear) or overcharge.
- In long stretches, do not use full speed consistently and varies the speed repeatedly.



## OPERATION AND IMPORTANT RIDING POINTS

- When facing steep slopes, downshift to have better power.
- After a long run do not stop the engine suddenly, leave it running at minimum acceleration for some seconds.
- Check the non-existence of oil, fuel or brake liquid leaks.
- In case of anomalous noise, try to identify its cause immediately.

## CAUTION

Most of the Safety and condition of vehicle depend on how you do the correct maintenance , periodic inspection, adjustment and lubrication. The following are contents that help the operator to do such skills on the following pages.

## WARNING

Maintenance, replacement, or repair of the emission control devices and systems may be performed by any repair shop or individual that is certified and must follow the local law regulations. If you are not familiar with maintenance work, have a dealer do it for you.

## OWNER'S TOOL KIT

The service information included in this manual and the tools provided in the owner's tool kit are intended to assist you in the performance of preventive maintenance and minor repairs. However, additional tools such as a torque wrench may be necessary to perform certain maintenance work correctly.

## CAUTION

If you do not have the tools or experience required for a particular job, have a dealer perform it for you.

## WARNING

Modifications not approved by maker may cause loss of performance, excessive emissions, and render the vehicle unsafe for use. Consult a dealer before attempting any changes. Modifications without authorization of the manufacturer cause void the warranty.

## SPARK PLUG

The spark plug is an important engine component, which is easy to check. Since heat and deposits will cause any spark plug to slowly erode, the spark plug should be removed and checked in accordance with the periodic maintenance and lubrication chart. In addition, the condition of the spark plug can reveal the condition of the engine.

The spark plug (1) is on the right, front side of the vehicle.

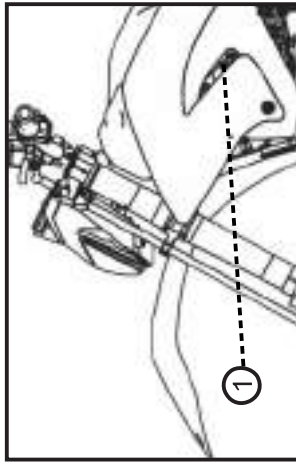

## PERIODIC MAINTENANCE AND MINOR REPAIR

### Check the spark plug

1. Remove cover
2. Remove the spark plug cap (1)

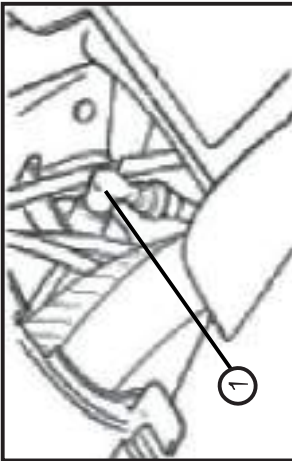

3. Remove the spark plug as shown, with the spark plug wrench (2) included in the owner's tool kit.

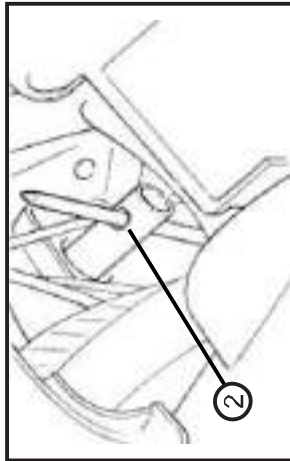

4. Check that the porcelain insulator (3) around the center electrode of the spark plug is a medium-to-light tan (the ideal color when the vehicle is ridden normally).

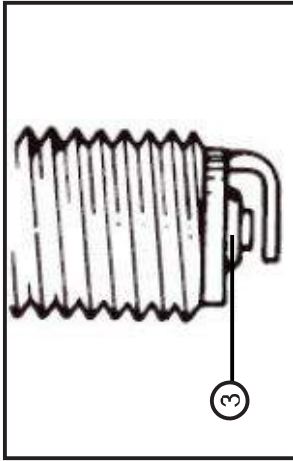

### CAUTION

If the spark plug shows a distinctly different color, the engine could be operating improperly. Do not attempt to diagnose such problems yourself. Instead, have a dealer check the vehicle.

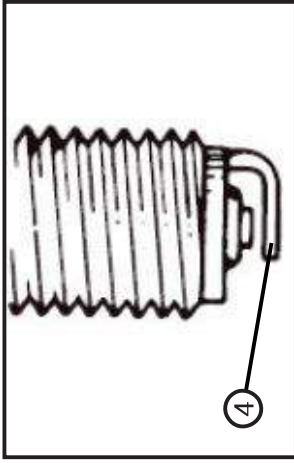

Specified spark plug:  
NGK - DR8EA

### WARNING

Please note that no other spark plug model is allowed. Using a different spark plug model can immediately lead to engine damage.

5. Check the spark plug for electrode erosion and excessive carbon or other deposits, and replace it if necessary.
6. Measure the spark plug gap with a wire thickness gauge and, if necessary, adjust the gap to specification. Clean the surface of the spark plug

gasket and its mating surface, and then wipe off any grime from the spark plug threads.

7. Install the spark plug with the spark plug wrench, and then tighten it to the specified torque.

**Spark plug gap: 0,6 - 0,7 mm**

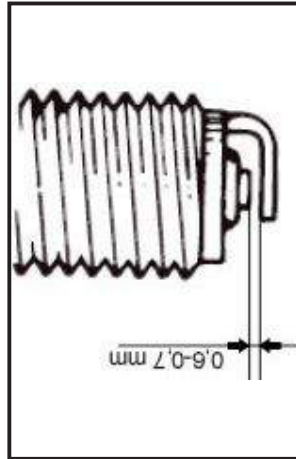

**⚠ WARNING**

Please note the max. torque when inserting the plug. If you do not have the ability to control you leave control of the spark plug to the dealer.

**Tightening torque: 12 Nm**

**ENGINE OIL**

Use a high-quality engine oil and change it regularly to extend the life of your engine.

**Check engine oil**

1. Run the engine.
2. Position the vehicle on its centre stand.
3. After a few minutes switch off the engine and wait one minute.
4. Check the oil level at the sight glass illustrated above. The oil level must be between the MAX (1) and MIN (2) marks.

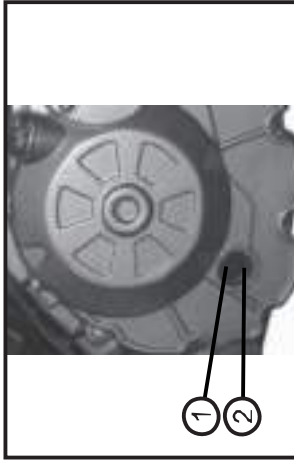

**Capacity:**  
**Full: 1,4 l / Change: 1,3 l**  
**4-stroke engine oil**  
**Recommended engine oil:**  
**Castrol Power 1 Racing 4T**

**⚠ WARNING**

At each refuelling you have to control the engine oil.

**CAUTION**

In dusty, cold or poor road conditions, the condition of the oil deteriorates

# PERIODIC MAINTENANCE AND MINOR REPAIR

more rapidly. Oil changes should therefore be carried out more frequently.

## Oil change

The engine oil can be topped up whenever this is needed but oil changes and oil filter replacements should be carried out by the specialist dealer because failure to carry out this work correctly could result in engine damage.

### **▲ WARNING**

- Make sure that no foreign material enters the housing.
- Make sure that no oil gets on the tire or wheel.

## FUEL FILTER

The petrol filter (1) is located directly next to the petrol tap underneath the fuel tank. Handling the petrol filter is hazardous as petrol may escape. Have the replacement carried out by the specialist dealer.



Replace the air filter more often if you drive in unusually wet or dusty areas.

## Replace the air filter

1. Remove the seat
2. Remove the side cover
3. Remove the screws (2), open the cover (3).
4. Remove the screws (4).
5. Now you can remove the air filter (1).
6. Coat the mating surfaces of the air filter case and air filter case cover lightly with grease for an airtight seal.
7. Install the air filter.
8. Mount the air filter housing.
9. Mount the side cover
10. Install the seat.

## AIR FILTER

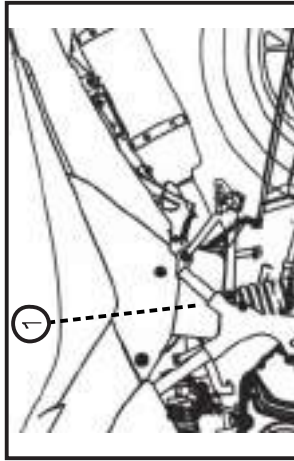

The air filter (1) should be replaced according to the maintenance schedule.

## CARBURETOR

The carburetor is an important part of the engine and its emission control system, which requires very sophisticated adjustments. Therefore, carburetor adjustments should be left to dealer, who has the necessary professional knowledge and experience.

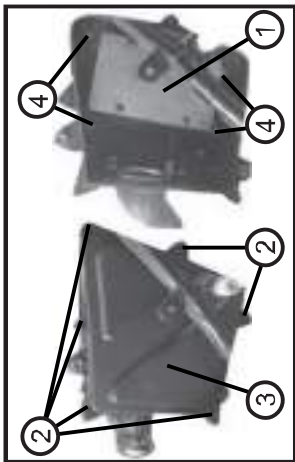

### CAUTION

- The air cleaner should be cleaned dry or using only a specially formulated cleaning agent.
- Make sure that the air filter element is properly seated in the air filter case.
- The engine should never be operated without the air filter element installed, otherwise the piston and/or cylinder may become excessively worn.
- If necessary, have the air cleaner exchanged by the specialist dealer.

## THROTTLE CABLE FREE PLAY

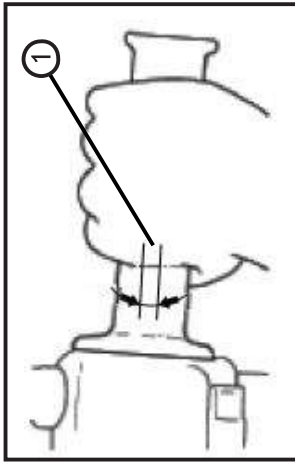

The throttle cable free play (1) should measure 1.5 ~ 3.5 mm at the throttle grip.

### CAUTION

Periodically check the throttle cable free play and, if necessary, have a dealer adjust it.

### Throttle cable free play adjustment

1. Release the locknut (1)
2. Rotate the adjusting nut (2) to adjust the clearance.

3. Tighten the lock nut (1) after adjusting the nut (2).

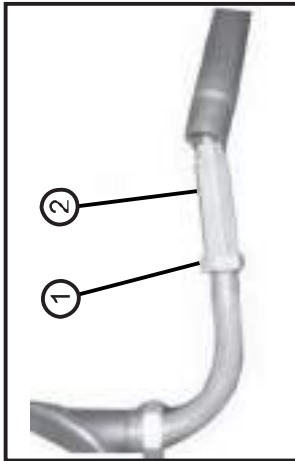

### **Clutch free play adjustment**

1. Loosen the locknut (1)
2. Turn the adjusting bolt (2) and the adjusting nut (3) in or out to meet the requirements of clutch free play.
3. Tighten the lock nut (1) after adjusting the nut (2).

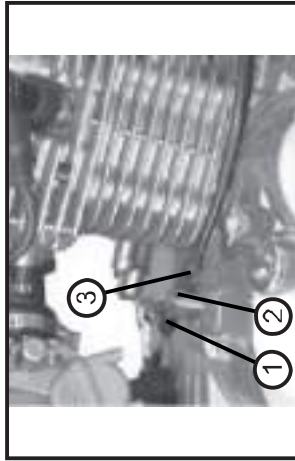

### **CLUTCH FREE PLAY**

The clutch free play should be 10-20mm.

#### **CAUTION**

Periodically check the clutch free play and, if necessary, have a dealer adjust it.



### **TIRES**

To maximize the performance, durability, and safe operation of your vehicle, note the following points regarding the specified tires.

#### **Tire air pressure**

The tire air pressure should be checked and, if necessary, adjusted before each ride.

#### **WARNING**

The tire air pressure must be checked and adjusted on cold tires (i.e., when the temperature of the tires equals the ambient temperature).

The tire air pressure must be adjusted in accordance with the riding condition. If you are not familiar to this, please have dealer for help.

# PERIODIC MAINTENANCE AND MINOR REPAIR

## Tire air pressure:

Front: 2.1 bar - 2.5 bar

Rear: 2.1 bar - 2.5 bar

Total weight of rider, passenger, cargo and accessories!

## Maximum load\*: 150kg

\*Total weight of rider, passenger, cargo and accessories

### **⚠ WARNING**

Do not over load your vehicle, since it will increase pressure on the tire, braking, steering than original design, and may cause damage or even lead to accident.

Allocation of your cargo and weight of your vehicle is very important for your own safety and vehicle performance. Load your cargo rmlly on vehicle and put the heaviest cargo to the center of vehicle, then distribute the weight evenly from side to side. It will keep you to have good steering after load.

## Tire inspection

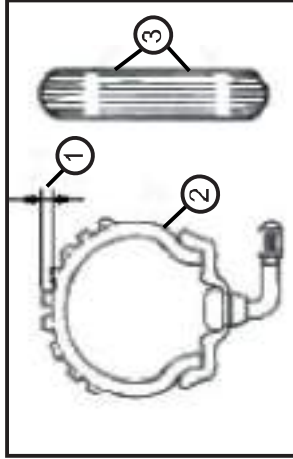

1. Tire tread depth
2. Tire sidewall
3. Tire wear indicator

### **⚠ WARNING**

The tires must be checked before each ride. If a tire tread shows crosswise lines (minimum tread depth), if the tire

has a nail or glass fragments in it, or if the sidewall is cracked, have a dealer replace the tire immediately.

### **CAUTION**

The tread depth may vary depending on country. Observe local regulations. The values listed here are technical values and may differ from the legal values of your region.

**Minimum tire tread depth:**  
Front and rear: > 1.6 mm

### **⚠ WARNING**

- Drive with worn tire is illegal, reduces stability and can lead to loss of control over the vehicle.
- Let worn or damaged tires replaced immediately by your dealer.
- Working tires and the dealer is responsible.



## DIMENSIONS TIRES / RIMS

### Front

Rim: 17x2.5

Tire: 100/80-17

### Rear

Rim: 17x3.0

Tire: 130/70-17

**Tyre type:** Tubeless

to the wheel. A deformed or cracked wheel must be replaced.

- The wheel should be balanced whenever either the tire or wheel has been changed or replaced. An unbalanced wheel can result in poor performance, adverse handling characteristics, and a shortened tire life.
- Ride at moderate speeds after changing a tire since the tire surface must first be "broken in" for it to develop its optimal characteristics.

## BRAKE FREE PLAY

### Front brake

#### CAUTION

There should be no free play at the brake lever end. If there is free play, have a dealer inspect the brake system.

#### WARNING

A soft or spongy feeling in the brake lever can indicate the presence of air in the hydraulic system. If there is air

in the hydraulic system, have a dealer bleed the system before operating the motorcycle. Air in the hydraulic system will diminish the braking performance, which may result in loss of control and an accident.

### Rear brake

#### WARNING

A soft or spongy feeling in the brake pedal can indicate the presence of air in the hydraulic system. If there is air in the hydraulic system, have a dealer bleed the system before operating the motorcycle. Air in the hydraulic system will diminish the braking performance, which may result in loss of control and an accident.

### Brake pedal free play

1. Loosen the locknut (1)
2. Turn the adjusting bolt (2) until the lever position is within specified position (10-20 mm free play on the lever)

## RIMS

To maximize the performance, durability, and safe operation of your motorcycle, note the following points regarding the specified wheels.

- The wheel rims should be checked for cracks, bends or warpage before each ride. If any damage is found, have a dealer replace the wheel. Do not attempt even the smallest repair

3. Tighten the locknut again.



**⚠ WARNING**

After adjusting make sure that the break pads do not drag. When there is no free play on the lever the pressure in the brake system will increase and the system can overheat and fail. If proper adjustment cannot be obtained as described contact a dealer to make this adjustment.

## BRAKE PADS

The brake pads must be checked for wear at the intervals specified in the periodic maintenance and lubrication chart.

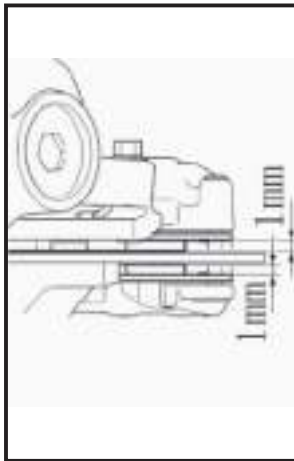

Each brake pad is provided with wear indicators, which allows you to check the brake pad wear without having to disassemble the brake. To check the brake pad wear, check the position of the wear indicators while applying the brake. If a brake pad has worn to the point that a wear indicator almost touches the brake disc, have a dealer replace the brake pads as a set.

## BRAKE FLUID

**⚠ WARNING**

Insufficient brake fluid may allow air to enter the brake system, possibly causing it to become ineffective. Before riding, check that the brake fluid is above the minimum level mark (1) and refill it if necessary.

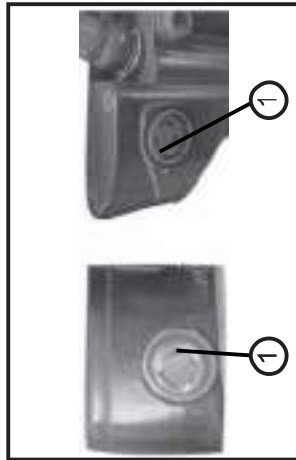

- Low position brake fluid level may indicate worn brake pads and/or brake system leakage.
- If the brake fluid level is low, be sure to check the brake pads for wear and the brake system for leakage.
- When checking the fluid level, make

# PERIODIC MAINTENANCE AND MINOR REPAIR

- Ensure that the top of the master cylinder is level by turning the handlebars.
- Use only the recommended quality brake fluid, otherwise the rubber seals may deteriorate, causing leakage and poor braking performance.

## DOT 4 brake fluid

(Only use brake fluid out from an unopened container)

- Refill with the same type of brake fluid. Mixing fluids may result in a harmful chemical reaction and lead to poor braking performance.
- Be careful that water does not enter the master cylinder when refilling. Water will significantly lower the boiling point of the fluid and may result in vapor lock.
- Brake fluid may deteriorate painted surfaces or plastic parts. Always clean up spilled fluid immediately.

- As the brake pads wear, it is normal for the brake fluid level to gradually go down. However, if the brake fluid level goes down suddenly, have a dealer check.

## Changing the brake fluid

### ▲ WARNING

Have a dealer change the brake fluid at the intervals specified in the NOTE after the periodic maintenance and lubrication chart.

### ▲ WARNING

Damage to the outer housing of cables may result in internal rusting and cause interference with cable movement. Replace damaged cables as soon as possible to prevent unsafe conditions.

## THROTTLE GRIP AND CABLE

The operation of the throttle grip should be checked before each ride. In addition, the cable should be lubricated at the intervals specified in the periodic maintenance chart.

## LUBRICATING THE BRAKE LEVER AND BRAKE PEDAL

The pivoting points of the brake lever and brake pedal must be lubricated at the intervals specified in the periodic maintenance and lubrication chart.

## CABLES

The operation of all control cables and the condition of the cables should be checked before each ride, and the cables and cable ends should be lubricated if necessary. If a cable is damaged or does not move smoothly, have a dealer check or replace it.

# PERIODIC MAINTENANCE AND MINOR REPAIR

## SIDE STAND

### CAUTION

The operation of the side stand should be checked before each ride, and the pivots and metal-to-metal contact surfaces should be lubricated if necessary.

### WARNING

If the main stand does not move up and down smoothly, have a dealer check or repair it.



## FRONT FORK

The condition and operation of the front fork must be checked as follows at the intervals specified in the periodic maintenance and lubrication chart.

### WARNING

Securely support the motorcycle so that there is no danger of it falling over.

1. Place the vehicle flat and upright from.
2. Check the inner tubes for scratches, damage and oil leakage.
3. Apply the front brake and push the handlebars several times down hard to verify the suspension of the fork.

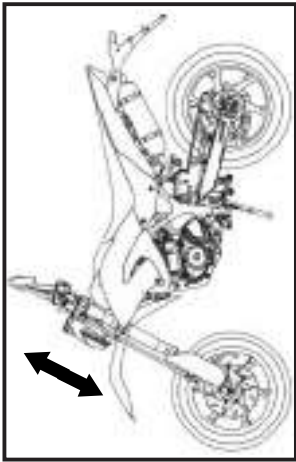

### WARNING

- When damage to the fork, please contact your dealer.
- If you treat the telescopic fork with cleaning agents, make sure that they get no contact with the tires or the brakes. This can lead to dangerous accidents.

## STEERING

### WARNING

Worn or loose steering bearings may cause danger. Therefore, the operation

# PERIODIC MAINTENANCE AND MINOR REPAIR

of the steering must be checked as follows at the intervals specified in the periodic maintenance and lubrication chart.

1. Place the vehicle on the center stand/suitable motorcycle stand to raise the front wheel off the ground.
2. Hold the lower ends of the front fork legs and try to move them forward and backward.
3. If any free play can be felt, have a dealer check or repair the steering.

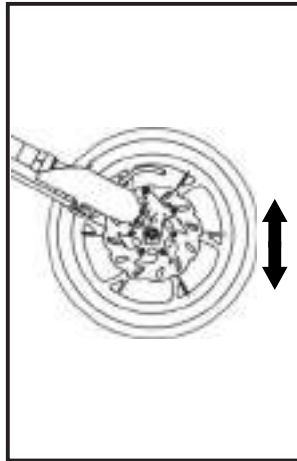

## WHEEL BEARINGS

The front and rear wheel bearings must be checked at the intervals specified in the periodic maintenance and lubrication chart.

### CAUTION

If there is play in the wheel hub or if the wheel does not turn smoothly, have a dealer check the wheel bearings.

If the chain tension is too great, parts within the secondary power transmission (chain, chain sprockets transmission and rear wheel bearings) will be subjected to unnecessary stress resulting in early wear and even chain breakage. Too much slack in the chain, on the other hand, can result chain jumping off the chain wheels. If this happens the chain could also block the rear wheel or damage the engine. In either case the operator is likely to lose control of the vehicle.

## DRIVE CHAIN

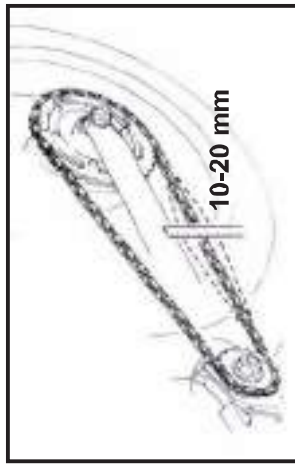

### Tensioning the chain drive

1. Loosen collar nut (1)
2. Turn right and left adjusting screws (3) equally far.
3. Turn the adjusting screws, on the right and left side of the tire, to set the correct free play. The drive chain free play should be between 10 mm and 20 mm.
4. Tighten the collar nut (1).

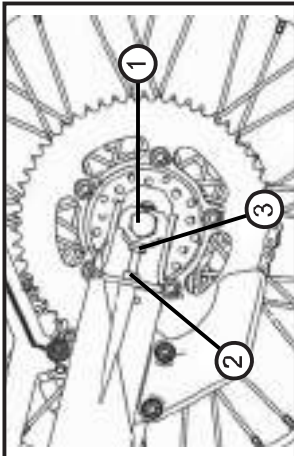

**Tightening torque of the collar nut (1): 70 Nm**

### Adjust the shock absorber

Use the nuts (1) and (2) to adjust the rear shock. Loosen the locknut (1) and adjust with the help of the nut (2) to adjust the preload of the shock absorber. Secure the damper then again with the locknut (1).

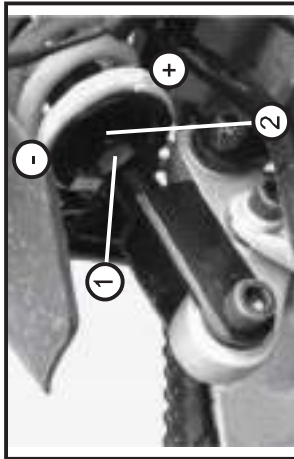

### BATTERY

The battery (1) is located under the seat.

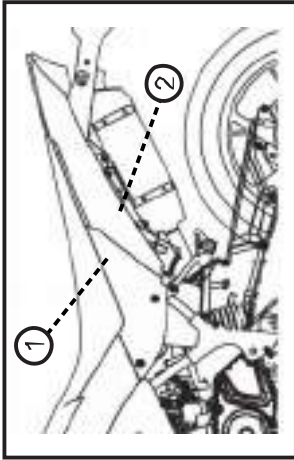

### Check the battery (1)

1. Remove the screws (2) of the bench. These can be found on the underside of the rear cover.
2. Take off the bench.

This model is equipped with a sealed-type (MF) battery, which does not require any maintenance. There is no need to check the electrolyte or to add distilled water.

### ▲ WARNING

- Do not remove the battery vent seal, this can be dangerous, the battery permanently damaged.

### SHOCK ABSORBER

Press the rear of the vehicle down to test the function of the rear damper. Make sure that no pressure is exerted on the exhaust in order not to damage it.

The shock absorber can be adjusted to suit the weight of the driver and the load.

# PERIODIC MAINTENANCE AND MINOR REPAIR

- Battery acid is poisonous and dangerous, it contains sulfuric acid and leads to dangerous burns.
- Avoid skin, eye and clothing contact. Protect your eyes always when working near the battery.
- Upon contact with the battery acid, make immediate FIRST AID.
- If skin or eye contact with battery acid, rinse the affected areas with plenty of water.
- When accidentally swallowed battery acid drink large amounts of water.
- In both cases, as soon as possible, see a doctor.
- Batteries develop explosive hydrogen gas. Keep open flames, smoking materials away from the battery and make sure there is adequate ventilation when you charge a battery indoors.
- **KEEP THIS AND ALL BATTERIES OUT OF THE REACH OF CHILDREN.**

## **Charge the battery**

Have a dealer charge the battery as soon as possible if it seems to have discharged. Keep in mind that the battery tends to discharge more quickly if the vehicle is equipped with optional electrical accessories.

## **Store the battery**

- If the vehicle will not be used for more than one month, remove the battery, fully charge it, and then place it in a cool, dry place.
- If the battery will be stored for more than two months, check it at least once a month and fully charge it if necessary.
- Fully charge the battery before installation.
- After installation, make sure that the battery leads are properly connected to the battery terminals.

## **WARNING**

Please contact your dealer if you are not familiar with handling the battery.

## **CAUTION**

Always keep the battery charged. Storing a discharged battery can cause permanent battery damage.

## **FUSE**

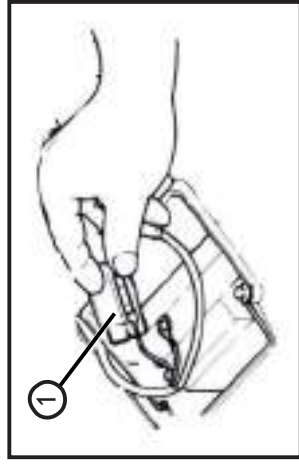

The fuse holder (1) is located behind battery.

## **Replacing the fuse**

1. Turn the key to  and turn off all electrical circuits.



# PERIODIC MAINTENANCE AND MINOR REPAIR

2. Remove the blown fuse, and then install a new fuse of the specified amperage.

**Specified fuse:**  
15 Amp

**⚠ WARNING**

**Do not use a fuse of a higher amperage rating than recommended to avoid causing extensive damage to the electrical system and possibly a fire.**

3. Turn the key to  and turn on the electrical circuits to check if the devices operate.  
4. If the fuse immediately blows again, have a dealer check the electrical system.

## LIGHTING

### Headlight

1. If the headlight bulb does not glow switch off all consumers and stop the engine.
2. Remove the bolts and screws (1 to 4) to disassemble the head light assembly.
3. Take out the rubber dust cover (5) and the pug (6).

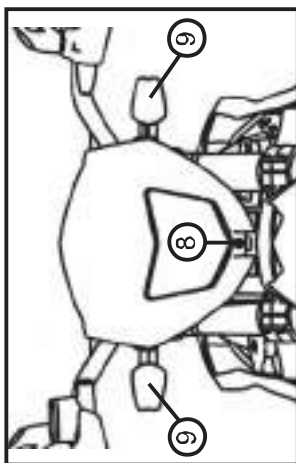
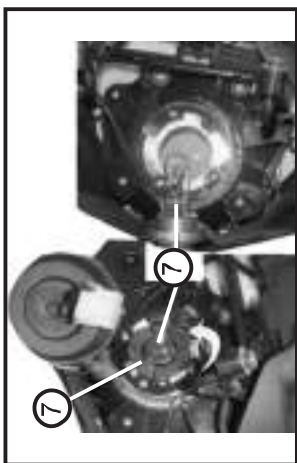
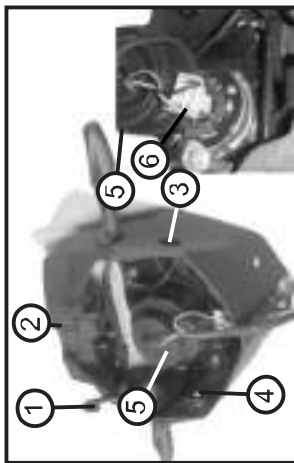

When you need to adjust the headlight turn in or turn out the adjusting screw (8).

4. Turn the fixing disc anti-clockwise to take out the the blup (7).



## PERIODIC MAINTENANCE AND MINOR REPAIR

### **Turn signal light - Front**

If the turn signal light bulb (9) does not come on, please contact your dealer to replace it.

### **Turn signal light - Rear**

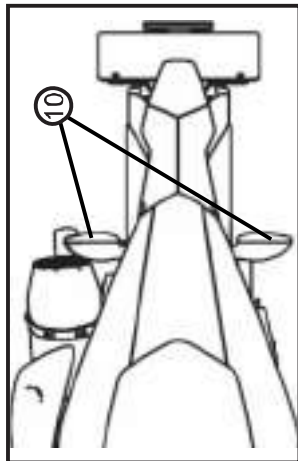

If the turn signal light bulb (10) does not come on, please contact your dealer to replace it.

### **Tail light / Brake light**

If the tail light / brake light (11) do not glow, please contact your dealer to replace it.



### **License plate light**

If the license plate light (12) do not glow, please contact your dealer to replace it.

## TROUBLESHOOTING

Although the vehicles receive a thorough inspection before shipment from the factory, trouble may occur during operation. Any problem in the fuel, compression, or ignition systems, for example, can cause poor starting and loss of power. The following troubleshooting chart represents a quick and easy procedure for checking these vital systems yourself. However, should your vehicle require any repair, take it to a dealer, whose skilled technicians have the necessary tools, experience, and knowhow to service the vehicle properly. Use only genuine replacement parts. Imitation parts may look like parts, but they are often inferior and have a shorter service life and can lead to expensive repair bills.

# TROUBLESHOOTING

## TROUBLESHOOTING CHART



**WARNING**

Keep away open flames and do not smoke while checking or working on the fuel system.

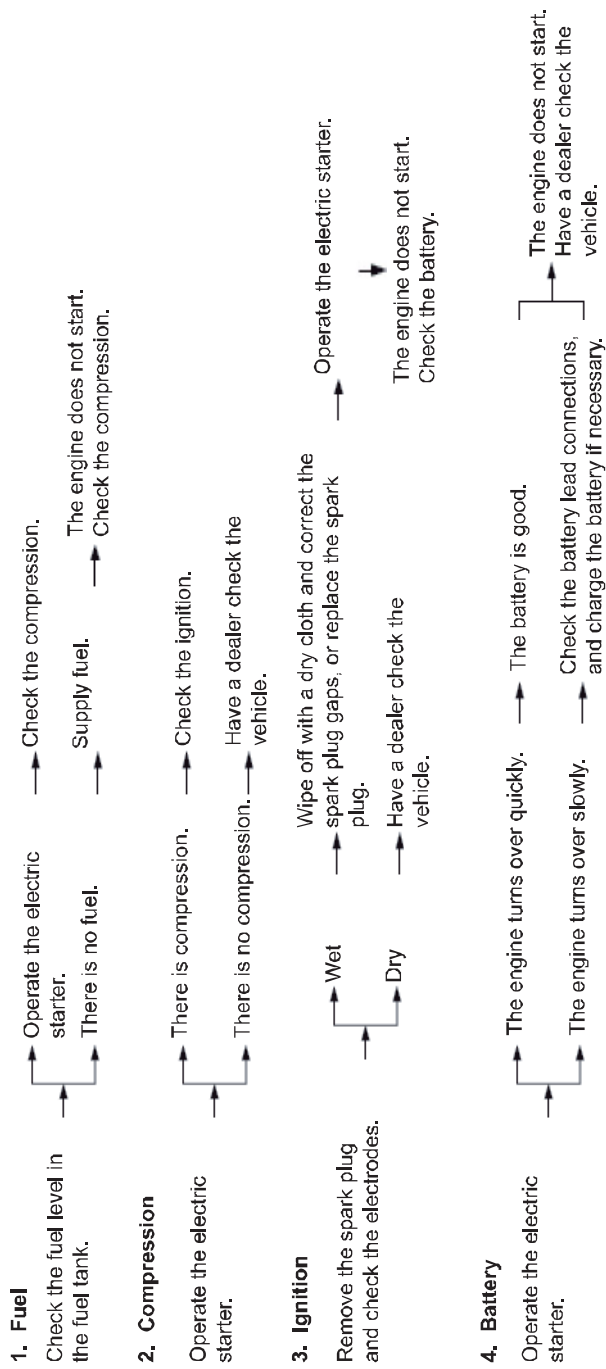

# CLEAN AND STORAGE

## CLEAN THE VEHICLE

Clean of the vehicle in proper and suitable way will make it attractive, extend its life and optimize the performance.

### **Before cleaning**

1. Cover the muffler outlet with a plastic bag to prevent water to come in side. Please do it only after the
2. Closed every caps, covers, electrical connectors that are well install and water can be avoid to get into, while you do the clean job.

### **CAUTION**

- Do not use acid-based cleaners. If such funds used for stubborn stains, so use this only occasionally, dry it immediately after and then apply a corrosion protection spray.
- Always follow the manufacturer's instructions on care and cleaning agents.
- Use best only water and mild detergent or special cleaner from the dealer to the sensitive components

of the vehicle to prevent damage. Dry the plastic parts then wipe with a soft, dry cloth or sponge.

- Protect particularly plastic parts, paint, headlight glass from harsh chemicals such as fuel, rust remover, brake cleaner or similar. The use of such agents may result in malfunction, damage and affect the security itself.
- Do not use a high pressure washer or steam cleaner, causing water in storage can penetrate electrical components such as connectors or switches, lighting, ventilation hoses, brake shoes and brake linings or damage, seals, paint and other surfaces.

### **Cleaning after normal use**

Remove dirt with warm water, a mild detergent, and a soft, clean sponge, and then rinse thoroughly with clean water. Use a toothbrush or bottlebrush for hard-to-reach areas.

**Cleaning after riding in the rain, near the sea or on salt-sprayed roads**

### **CAUTION**

Since sea salt or salt sprayed on the roads during winter are extremely corrosive in combination with water, carry out the following steps after each ride.

- Wait until the engine / exhaust have cooled.
- Clean the vehicle with warm water and a mild detergent.
- Do not use hot water, which increases the corrosive effect of the salt.
- Apply a corrosion protection spray on all metal, including chrome- and nickel-plated, surfaces to prevent corrosion.

### **After cleaning**

- Dry the vehicle.
- To prevent rust, we recommend appropriate care to use according to manufacturer's instructions.
- Wax all painted surfaces.

## **▲ WARNING**

- Make sure that there is no oil or wax on the brakes or tires.
- If necessary, clean the brake discs and brake linings with a regular brake disc cleaner and wash the tires with warm water and a mild detergent.
- Before operating the vehicle, test the braking performance and tires.

## **STORAGE**

### **Short-term (for a few days)**

- Always store your vehicle in a cool, dry place and, if necessary, protect it against dust with a vehicle cover.

## **▲ WARNING**

Please store the vehicle in a well air flow room with dry air if possible. A place with wet humidity will cause rust.

### **Long-term (for weeks)**

- Clean the vehicle.
- Drain the fuel from the carburetor.
- Enter the drained fuel back into the fuel tank.
- Fill the fuel tank to completely or add if necessary a fuel stabilizer to protect the fuel tank from rusting and the fuel from degradation.

Follow the steps below to cylinders, piston rings, etc. to prevent rusting.

- Remove spark plug cap and the spark plug.
- Give a teaspoon of engine oil into the spark plug hole.
- Join the Kickstarter to slow down and let the engine several times slowly rotate (thus the cylinder is oiled).
- Put the spark plug back in and put on the spark plug cap.

# SPECIFICATIONS

## DIMENSIONS

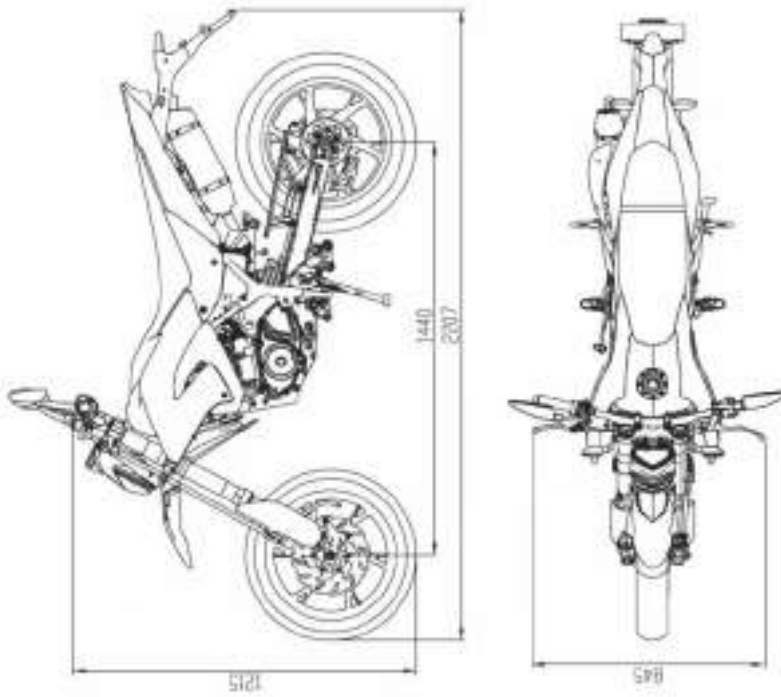

# SPECIFICATIONS

ENGINE		SPARK PLUG	
Type	4-stroke, air cooled	Manufacturer	NGK
Cylinder arrangement	Forward-inclined single cylinder	Type	DR8EA
Displacement	125 cm <sup>3</sup>	Spark plug gap	0.6-0.7mm
Compression ratio	10.6:1	<b>CLUTCH</b>	
Starting system	Electric starter	Clutch type	Multiple plate clutch
Lubrication system	Separate lubrication	Transmission type	5-speed constant mesh transmission
<b>OILS</b>		<b>CHASSIS</b>	
<b>Engine oil</b>		Type	Steel tube
Type	4-stroke engine oil Recommendation: Castrol Power 1 Racing 4T	<b>TIRE</b>	
Quantity	1.4 l	Front tire	17x2.5
<b>FUEL</b>		Tyre	100/80-17
Type	Unleaded gasoline only	Tire air pressure	2.1 bar - 2.5 bar
Quantity	7.0 l +/- 0.3 l	Rear tire	17x3.0
<b>CAUTION</b>	<b>!! BIOETHANOL FUEL - E10 IS NOT PERMITTED !!</b>	Tyre	130/70-17
<b>AIR FILTER</b>		Tire air pressure	2.1 bar - 2.5 bar
Type	Paper element	The selected tire pressure depends on the load!	
<b>CARBURETOR</b>		<b>BRAKE SYSTEM</b>	
Manufacturer	Exact	Front brake	Single Hydraulic disc brake

# SPECIFICATIONS

Size	280mm
Operation	Right hand
	<b>Rear brake</b>
Type	Single Hydraulic disc brake
Size	240mm
Operation	Right foot
	<b>Brake fluid</b>
Type	DOT 4
	<b>SUSPENSION</b>
	<b>Front suspension</b>
Type	Telescopic fork
Spring / Shock absorber type	Coil spring / Oil damper
	<b>Rear suspension</b>
Type	Unit swing
Spring / Shock absorber type	Gas / Oil damper
	<b>ELECTRIC SYSTEM</b>
Ignition system	CDI
Charging system	CDI magneto
	<b>BATTERIE</b>
Model	YTX7A-BS

Voltage, capacity	12 V, 8Ah
	<b>LAMPS</b>
Headlight	12 V, 35 W / 35 W
Tail light / Brake light	12 V, 5 W / 21 W LED
Front turn signal light	12 V, 10 W LED
Rear turn signal light	12 V, 10 W LED
License plate light	12 V, 5 W
	<b>FUSE</b>
Main fuse	15 A



## CONSUMER INFORMATION

### VEHICLE IDENTIFICATION NUMBER (VIN)

Please write down the VIN (vehicle identification number) to order replacement parts from your dealer or the vehicle should be stolen.

The vehicle identification number of the vehicle (1) is stamped on the steering head (right).

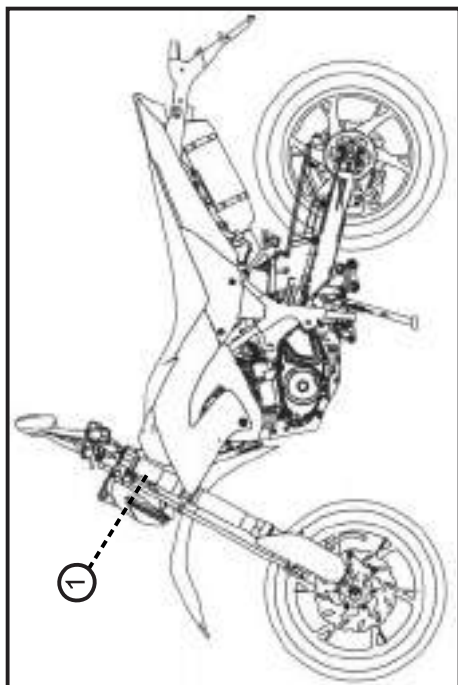

### CAUTION

The vehicle identification number is used to identify your motorcycle and may be used to register your vehicle with the licensing authority in your area.

## WARRANTY INFORMATION

Please carefully read the instruction manual of your vehicle before operating it in order to make yourself familiar with its handling. We explicitly point out that the instruction, maintenance, and care instructions given in the operating manual have to be complied with in order to sustain your claim towards warranty. Only the strict compliance with customer specifications stated in the instruction manual ensures the prolonging of the natural life of your vehicle. Starting with the date of the invoice a limited warranty of 24 months is granted regarding the accuracy of the vehicle in terms of material and manufacturing according to latest standards. The legal warranty regulations will not be restricted by this limited guarantee. Maintenance work has to be exclusively done by authorized workshops entitled by us. Warranty in general is bound to the region of invoicing and can therefore only be carried out within the country the vehicle was bought. Damages that can be traced back to inappropriate usage, manipulation, or neglecting of the maintenance/care/operating instructions will not be covered by warranty. Warranty can only be granted if occurring damages are immediately being reported to the seller or any other authorized workshop by the buyer. The warranty claim entitles the buyer to remedy deficiencies or to the repairation respectively the exchange of a damaged part in an authorized workshop after our approval. Compensation for remote or instantaneous damages cannot be granted. Vehicles in desolate condition will not be covered by warranty. Repair works carried out on warranty do not enlarge the guarantee period. Only this document entitles you to call on warranty services. Therefore please make sure that you are delivered this fully filled in document by the seller and that he has registered your vehicle correctly in our system. Please also mind the following advices.

Body and panelling of the vehicle have to be kept free of dirt constantly. Do not use high pressure water blasters, strong jets of water, sharp and corrosive or other aggressive detergents which could harm surfaces and varnish permanently and foster corrosion. It is vital to use protecting cleansers. Please consult our dealers for the right and appropriate products. Aluminium parts or other refined parts (chrome parts, anodized parts or other processed surfaces) have to be treated with appropriate maintenance products in order to prevent oxidation. Frame and metal parts are continuously to be treated with anticorrosive. A vehicle constantly parked outside has to be covered to avoid weathering and crack formations on seat and plastic parts. Vehicles used off-road and for racing purposes are excluded from warranty.

Material which is to be used in the context of service and maintenance works are excluded from warranty as well as the following parts: incandescent bulbs, brake pads, clutch lining, filter elements, spark plugs, drive sprocket, wheel and axle, as well as the tires.

# SERVICE AND MAINTENANCE

## IMPORTANT INFORMATION

*The date for the implementation of maintenance that limit is observed, which is reached first. That means driven kilometer or duration from initial startup.*

*The warranty can be granted only when the vehicle serviced in accordance with this plan and was not exposed to extraordinary stress.*

**▲ WARNING** Only appropriate works which are intended for your vehicle perform.

**CAUTION** Variomatik belt, variomatik rollers, spark plug, fuel filter and air filter must be replaced every 7000 km. Hydraulic lines should be replaced every 4 years.

From 13000km or the 24th month, the inspection should take place at least once a year or every 7000km. The vehicle is continuously checked for rust. The vehicle owner is responsible for rust prevention.

On the following pages you will find the maintenance schedule and the service record.

# SERVICE AND MAINTENANCE

## MAINTENANCE SCHEDULE

The inspection intervals are required, these will void the warranty.

COMPONENT	PERFORM	1000km or 1 Month	4000km or 6 Month	7000km or 12 Month	10000km or 18 Month	13000km or 24 Month
Air filter	Clean/ Exchange	✓	✓	Exchange	✓	✓
Wheels, Rims	Control	✓	✓	✓	✓	✓
Tire	Control of tread depth / Pressure		✓	✓	✓	✓
Wheel bearing	Control / Exchange	✓	✓	✓	✓	✓
axle bearing	Control / Clean / Lubricate	✓	✓	✓	Lubricate	✓
Glass cover	Control / Realigner	✓	✓	✓	✓	✓
Brake system	Control / Clean / Exchange	✓	✓	✓	✓	✓
Main stand	Control / Clean / Lubricate	✓	✓	✓	✓	✓
Telescopic fork	Control	✓	✓	✓	✓	✓
Shock absorber rear	Control	✓	✓	✓	✓	✓
Oil separator / Spin filter	Clear	✓	✓	✓	✓	✓
Engine oil / Oil filter	Exchange / Control	Exchange	✓	Exchange	✓	Exchange
Trans-mission oil	Exchange	✓	✓	✓	✓	✓
Valves	Control / Adjust	✓	✓	✓	✓	✓
Valve/maint belt	Check / Exchange	✓	✓	Exchange	✓	✓
Valve/maint rdes	Check / Exchange	✓	✓	Exchange	✓	✓
Drive chain / Pinion	Control / Clean / Exchange	✓	✓	✓	✓	✓
Clutch	Control	✓	✓	✓	✓	✓
Cables / Bowden	Control / Clean / Lubricate	✓	✓	✓	✓	✓
Tire/ tire	Control / Adjust / Lubricate	✓	✓	✓	✓	✓
Lights / switch	Control / Adjust	✓	✓	✓	✓	✓
Fuel line / filter	Control / Exchange	✓	✓	Exchange	✓	✓
Idle speed	Control / Adjust	✓	✓	✓	✓	✓
Electrical system	Control / Realigner	✓	✓	✓	✓	✓
Cable fit	Control	✓	✓	✓	✓	✓

# SERVICE AND MAINTENANCE

## SERVICE RECORD

*In the delivery of the vehicle the customer data and vehicle data must be supplemented.*

Maintenance interval: <i>Delivery inspection</i> Odometer reading: _____ Date: _____ Stamp / Signature _____	Maintenance interval: <i>1000 km or 1. month</i> Odometer reading: _____ Date: _____ Stamp / Signature _____	Maintenance interval: <i>4000 km or 6. month</i> Current odometer reading: _____ Date: _____ Stamp / Signature _____
Maintenance interval: <i>7000 km or 12. month</i> Odometer reading: _____ Date: _____ Stamp / Signature _____	Maintenance interval: <i>10000 km or 18. month</i> Odometer reading: _____ Date: _____ Stamp / Signature _____	Maintenance interval: <i>13000 km or 24. month</i> Odometer reading: _____ Date: _____ Stamp / Signature _____
Maintenance interval: <i>16000 km</i> Odometer reading: _____ Date: _____ Stamp / Signature _____	Maintenance interval: <i>19000 km</i> Odometer reading: _____ Date: _____ Stamp / Signature _____	

VEHICLE IDENTIFICATION NUMBER : \_\_\_\_\_ NAME OF THE CUSTOMER: \_\_\_\_\_

MODEL : \_\_\_\_\_ SIGNATION OF THE CUSTOMER: \_\_\_\_\_



**SPACE FOR NOTES**

Copyright © 2015  
All rights reserved.  
This user manual is copyrighted.  
Copying in mechanical, electronic or any other form without the written permission of the manufacturer is prohibited.

**Distributed by:**

KSR Group GmbH  
Gewerbeparkstrasse 11  
3500 Krems a. d. Donau  
Austria

**The copyright is owned by the Company / Manufacturer:**

KSR Group GmbH  
Gewerbeparkstrasse 11  
3500 Krems a. d. Donau  
Austria

Product and specifications are subject to change without notice.

