

CONTENTS

CHAPTER ONE

Common instruction -----	1
● Main specification (NAC12)	● Failure Diagnose:
● Operation notice items	Eninge unusal after starting few minutes
● Torque standard value	No power, no speed under high speed status
● Chasis	Idle speed running, bad in low speed
● Tools	Generator no good when medium,high speed running
● Lubricated parts breakdow	No spark
	No good charge (battery out of eletricity or over charge)

CHAPTER TWO

NAC12 Inspection & Adjustment-----	10
● Methods of inspection & adjustment	
Steering Device	Gearing
Braking device	Lubrication Device
Wheel device	Engine
Cushion device	Fuel device

CHAPTER THREE

Engine-----	18
● Maintain notice	
● Engine knock down, installation	
● Torque	
1. carburator	7 .clutch
2. magneto knock down and installation	8. oil pump
3 rocker base	9.shift gears installation and dissamble
4. camshaft installation and disassemble	10.crankshaft installation and remove
5.cylinder head remove and installation	11. engine lubrication system chart
6.cylinder body	12.engine cooling system chart
● Engine Maintain	
● Engine Overhauling	
Knock down of the engine	
Installation of engine	

CHAPTER FOUR

Electric device -----	31
● Maintain notice	
● Faults Diagnose	
voltage low	engine runs unnormaly
un steady electric current	ignition system second loop
poor connection of charging system	ignitation time
no spark by spark plug	light dim
start motor does not work	
start motor poor power	
engine does not work while start motor is okay pointer of fuel gauge unsteady	
● Battery	
● Charge	

Common instruction

Serial locations



Engine number



chassis number

Main specification (NAC12)

Model name		NAC12	
length (mm)	2180	min. wheel radius	5130mm
width(mm)	800	cooling	water
height(mm)	1090	start	electric
wheel base	1510	engine type	4 stroke
Engine type	water cool	cylinder style	double cylinder horizontal
	Double cylider.		
displacement	124.6ml	compound style	overhead camshaft
fuel type	gasoline	dimension x stroke	44×41
vehicle weight	front	77	compression ratio
	rear	88	max. power
	ttl	165	max.torque
seat number	2	final drive ratio	2.9
vehicle total weight	front	102	drive style
	rear	138	VIN serial
	ttl	240	Engine serial
ground clearance	180mm	Min.idle speed r/min	1500±100
front inclination	30 degree		

Main maintain data(NAC12)

Please refer to maintain specification if you find no data in below column

Item	standard	limit
lubrication device		
Engine oil capacity	1.9L	
oil exchange	1.6L	
Suggested engine oil	SAE10W/40 API SG	
fuel device	93	
fuel capacity	total	18.5
	spare	2.7
air filter	original resistance	0.15kPa
carburator	type	PD26JS
front and rear wheel		
wheel	rim jump radial	2.0mm
	horizontal	2.0mm
tire	air pressure front wheel	90/90-18 225kpa
	rear wheel	130/90-15 225kpa
front brake	type of brake liquid	DOT3
	thickness of brake liquid gasket	6.4mm
	thickness of disc brake	4
rear brake	off-center disc brake	0.3mm
	thickness brake liquid washer	3
	thickness of disc brake	4
disc brake off center		0.3mm
Ignition		
spark plug standard	A6RTC	
(continuous low speed drive in winter)	A5RTC	
(continuous high speed drive in summer)	A7RTC	
clearance of spark plug	0.6-0.7mm	
lubrication style	constraint lubrication style	
oil pump style	piston style	
cooling style	water cooling	
fuel device		
fuel tank capacity	18.5L	
fuel tank spare oil	2.7L	
clutch		
clutch style	multi-plate wet	
clutch model	five gears transmission	

item		standard	limit
front, rear wheel			
wheel	rim jump	radial	2.mm
		horizontal	2.0mm
	wheel axle bent		0.2mm
tire	air pressure	front wheel	0.225MPa
		rear wheel	0.225MPa
	size	front wheel	90/90-8
		rear wheel	130/90-15
brake			
brake		DOT3 or DOT4	
ignition loop			
	resistance value (20°C) once	0.36-0.4Ω	
	2nd test without spark plug cap	5KΩ	
charging system、DC generator			
	DC generator style	DC	
		12V	
lighting, switch, meter			
lighting, electric bulb	front light	12V-35W/35W	
	brake light, taillight	12V-21/5W	
	indicator light	12V-10W×4	
	fuse	15A	
batter			
	capacity	12V-9Ah	
	voltage ends	13.0-13.2V(20°C)	
	charging current(standard)	0.9A(5h)	

Operation notice items

cylinder gasket, O ring ,clip hoop, open pin etc disassembled, you should replace the new one



when tighten the screw, screw cap, bolt, please follow the first big then small, first side then outside, per the specified fixture torque, on the cross

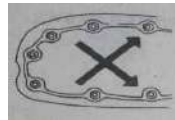

Please use special currency tool

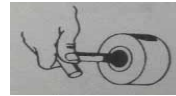

when parts disassembled, pleas clean it before checking and measuring, please apply the grease on friction side when assembling.



please apply the special butter on special part.



please check every fixture and action status after assembled.



please remove the battery cathode before operation

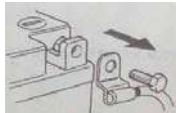

Please check the connection, fixing and assembly status when done
 please connect the anode when install the battery.
 please apply the butter after anoding
 please cover ends completely



Please check the reason and repair it when fuse is burned, then replace the same spec fuse



please apply the cover and cap after operation.



please hold the connection peg to disassemble it, no pulling

the wires.

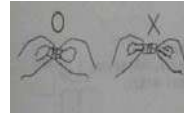

please check the ends is bent, broken before connecting the plug.
the ends are over long or fallen off.

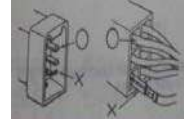

The connection plug must be connected tightly.
please check if the lock up is totally fixed because connection plug is with lock up.
please check if the wires are fallen off.

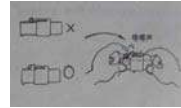

do not nip the wire when installing the part.



Do not fix the wire on the over heat part

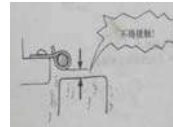

Please remove the lock up when disassemble the connection plug with lock up.

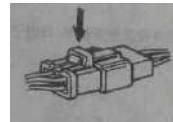

Do not bend or over move the tightwire, because the bad tightwire will cause the bad movement.

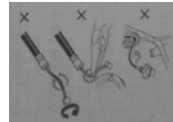

**Torque
standard value**

Type	torque value (N.m)	type	torque value (N.m)
5mm bolt、nut	4.5-6.0	5mm screw	3.5-5.0
6mm bolt、nut	8-12	6mm screw、bolt	7-11
8mm bolt、nut	18-25	6mm screw、bolt	10-14
10mm bolt、nut	30-40	8mm screw、bolt	24-30
12mm bolt、nut	50-60	10mm screw、bolt	35-45

Engine

item	number	screw thread diameter (mm)	torque(N.m)	Remark
flywheel nut	1	10	39.2	
mounting oil pump bolt	1	10	39.2	
cylinder cove bolt	4	6	9.8	
spark plug	1	14	13.4	
oil pump bolt	3	4	4.4	
driven bolt	1	28	53.9	
clutch outer nut	1	10	39.2	
oil adjuster bolt	1	10	17.6	
carburator mounting bolt	2	6	9.8	flange bolt
invalve bolt	4	8	9.8	special bolt
transmission bolt	8	10	13.7	flange bolt
cooling fan bolt	2	6	9.8	

Chassis

item	number	screw thread diameter (mm)	torque (N.m)	Remark
handle mounting bolt	1	10		
steering shank mounting nut	1	25.4		
roundness top washer	1	25.4		
front axle nut	1	12		
rear axle nut	1	14		
disc brake bolt	3	8		
torque shank bolt	1	8		
torque shank nut(side fork legs)	1	10		
exhaust pipe	1	8		
clip hoop bolt	1	8		
brake tube bolt	2	10		
rear brake arm bolt	1	8		
front transmission top bolt	1	8		
front transmission base bolt	1	8		
front transmission base nut	1	8		
front suspension locknut	1	8		
front transmission arm mounting nut	1	10		
rear transmission top bolt	1	10		
transmission base bolt	1	8		
rear shock lock nut	1	8		
oil pump cable support bolt	2	5		
engine mounting bolt	1	10		
muffler mounting bolt	2	8		

Tools

tool	code	part(install or remove)
outside handle	00749-0010000	bearing
sleeve wrench 39×41mm	07GMA-KS40100	clutch, driven belt sprocket
clutch spring compressor	07960-KM10000	
bearing drive into tool	07945-GG80000	for driven belt axle bearing drive into
* trunk puller	0735-KG80001	engine driven belt sprocket
movement slip-proof	07725-0030000	engine exterior mounting lock nut clutch exterior locknut
pile driver24×26mm	07746-0010700	for driven belt axle bearing drive into
handle wrench	07749-0010000	bearing
pile driver32×35mm	07746-0010100	crankcase(side),rear crankcase (side cover)
pile driver 37×40mm	07746-0010200	crankcase (side),rear crankcase(side cover)
flat reamer 17mm	07746-0040400	engine crankcase(side),bearing, drive belt bearing
flat reamer 15mm	07746-0040300	rear crankcase(side cover) bearing
flat reamer 12mm	07746-0040200	engine crankcase(side)bearing
crankshaft mounting bearing	07965-GM00300	engine crankshaft
crankshaft mounting base	07965-GM00100	
case puller	07935-KG80001	crankshaft bearing
case puller	07935-GK80000	crankcase divide up
movement bearing puller	07631-0010000	crankshaft bearing
bearing protector	07931-1870000	
outside handle 52×55mm	0746-0010400	replace crankshaft bearing
flat reamer 20mm	07746-0040500	
mounting base	07965-GG70100	install the left bearing seal of crankshaft
crankshaft mounting bearing	07965-GM00300	
crankshaft mounting bearing	07965-GM00300	crankshaft bearing,crankcase bearing oil seal
crankshaft protector	07965-GM00100	crankcase installation
outside handle A	07949-0100000	replace crankshaft bearing
locknut wrench A	07916-1870101	top bearing base installation and remove
locknut wrench B	07916-KM10000	top bearing base installation and remove
wheel bearing base separator	07946-GA70000	remove wheel top bearing base ring
bumper compressor accessory	07967-KM10100	disassemble the front bumper
bumper accessory A	07967-GA70102	
bumper compressor	07GME-0010000	
— compressor screw set	07GME-0010100	
bumper compressor	07GME-0010000	disassemble the rear bumper
— compressor screw set	07GME-0010100	
* bumper compressor accessory	07JME-GW20100	
movement slip proof	07725-0030000	flywheel disassemble and installation
flywheel protector	07733-0010000	remove flywheel

Lubricated parts breakdown

Engine

parts to use	name	remark
cylinder,piston&crankshaft running and slilage	GP2 (separator oil supplier)	
running and slilage inside the crankcase		

Chasis part

Please supply the grease on the following parts

You could use the normal butter on normal parts

Please supply the lubricate or lubrication grease on the following unpointed parts in order to raise its service



headlight wiring



right indica left indicator



odometer wiring



clutch switch wiring



fuel sensor wiring



flameout switch wiring



stop accelerator cable start accelerator cable



safe box wrinkle



anode connection

cathode connection



voltage regulation rectifier head



ignition hoop

aeration tube



fuel tank switch

Failure Diagnose

Here we clarify the close judgement on failure diagnose with the engine . Please refer to the every instruction per the un mentioned items.

unable to start or difficulty in starting

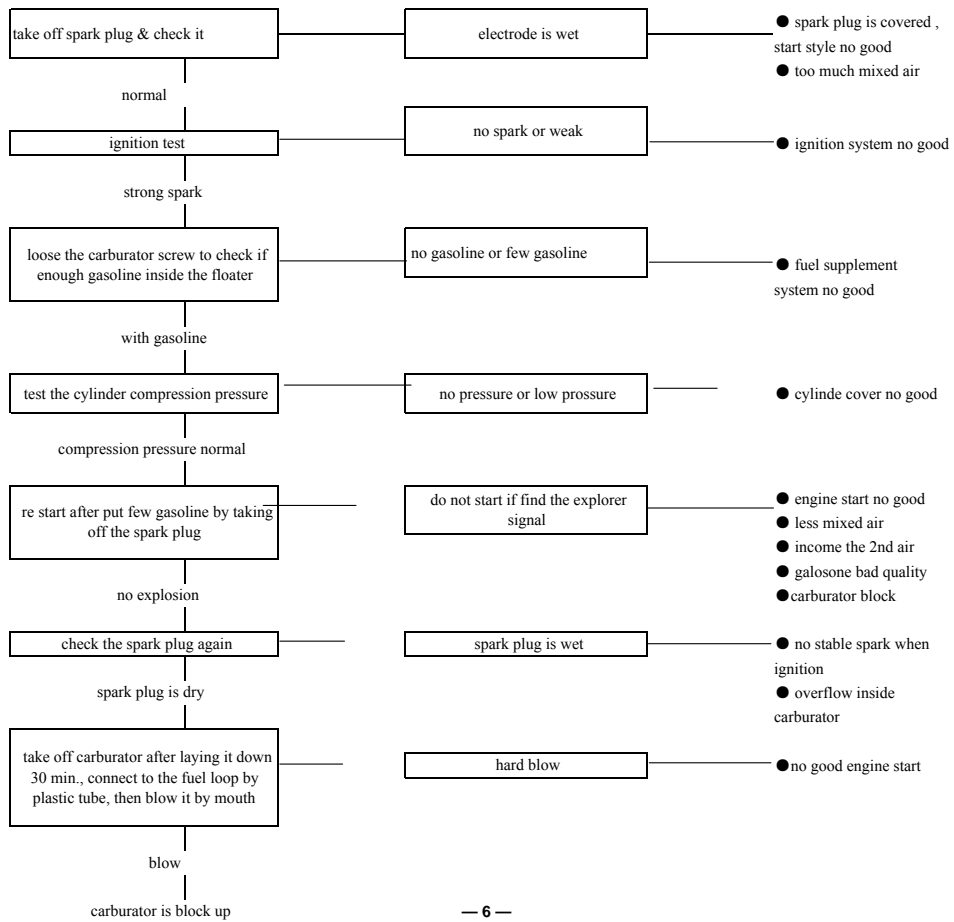

engine unusual after starting few minutes

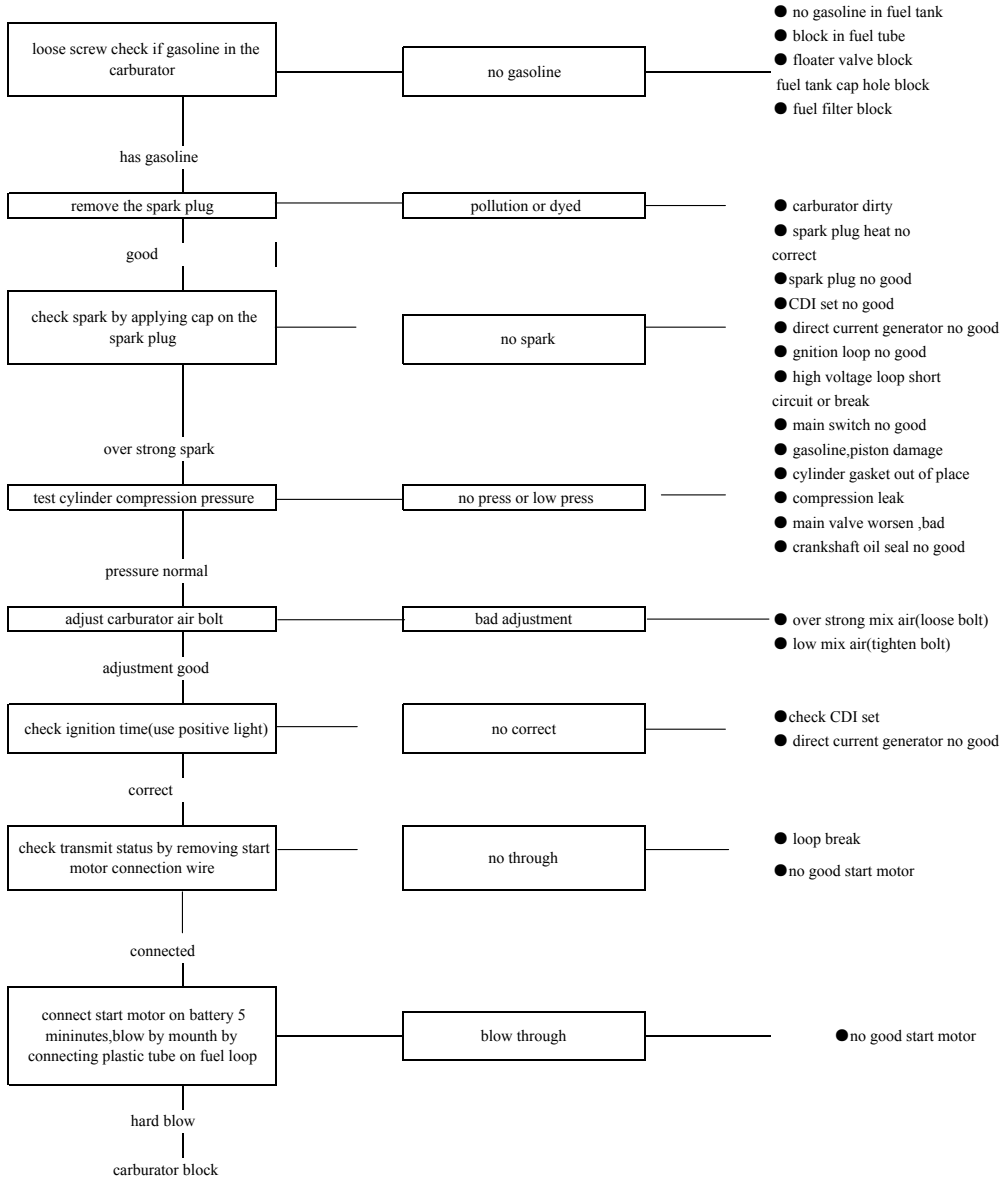

- no gasoline in fuel tank
- block in fuel tube
- floater valve block
- fuel tank cap hole block
- fuel filter block

- carburetor dirty
- spark plug heat no correct
- spark plug no good
- CDI set no good
- direct current generator no good
- ignition loop no good
- high voltage loop short circuit or break
- main switch no good
- gasoline, piston damage
- cylinder gasket out of place
- compression leak
- main valve worsen, bad
- crankshaft oil seal no good

- over strong mix air (loose bolt)
- low mix air (tighten bolt)

- check CDI set
- direct current generator no good

- loop break
- no good start motor

- no good start motor

No power, no speed under high speed status

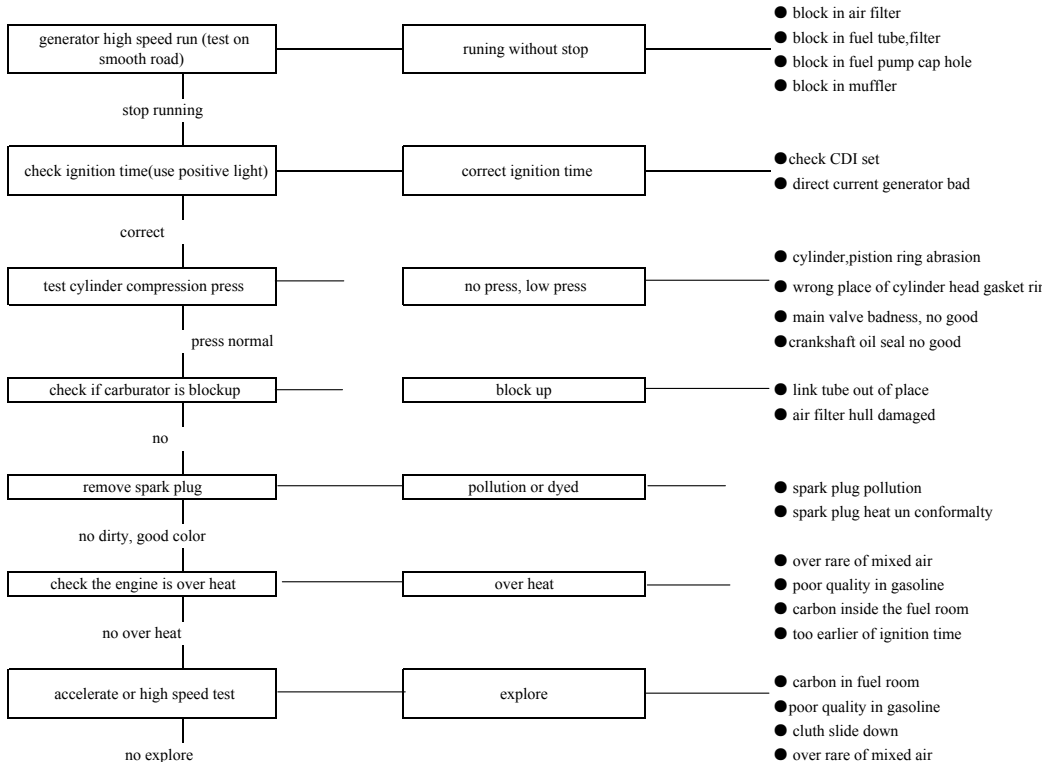

- block in air filter
- block in fuel tube, filter
- block in fuel pump cap hole
- block in muffler

- check CDI set
- direct current generator bad

- cylinder, piston ring abrasion
- wrong place of cylinder head gasket
- main valve badness, no good
- crankshaft oil seal no good

- link tube out of place
- air filter hull damaged

- spark plug pollution
- spark plug heat un conformity

- over rare of mixed air
- poor quality in gasoline
- carbon inside the fuel room
- too earlier of ignition time

- carbon in fuel room
- poor quality in gasoline
- cluth slide down
- over rare of mixed air

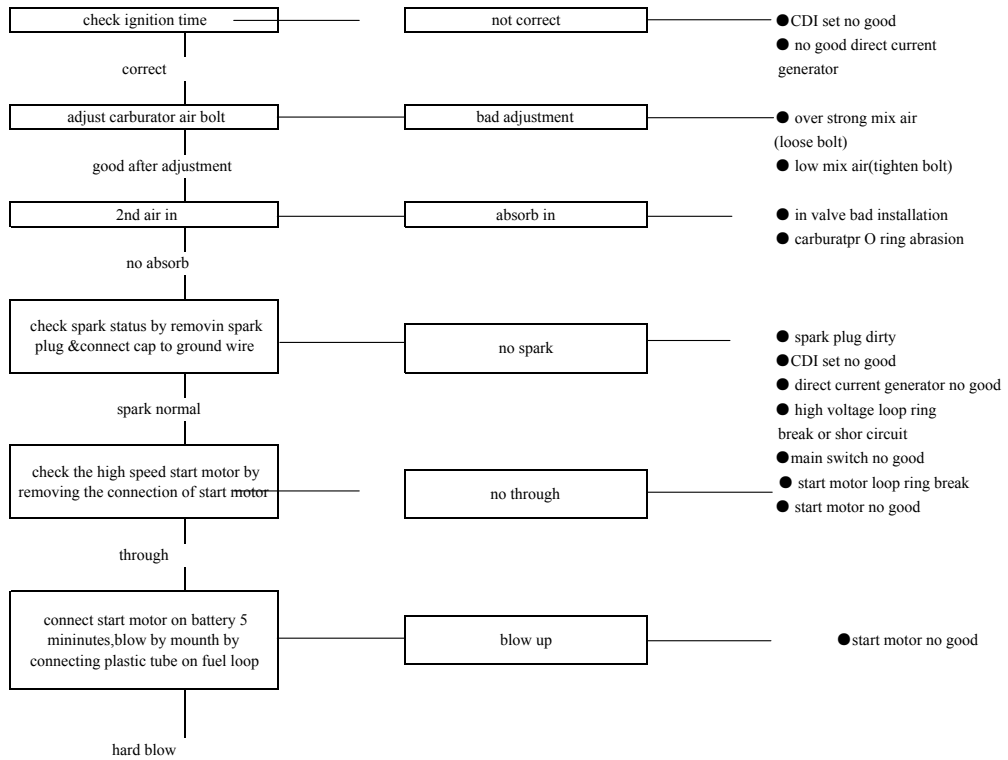

Generator no good when medium,high speed running

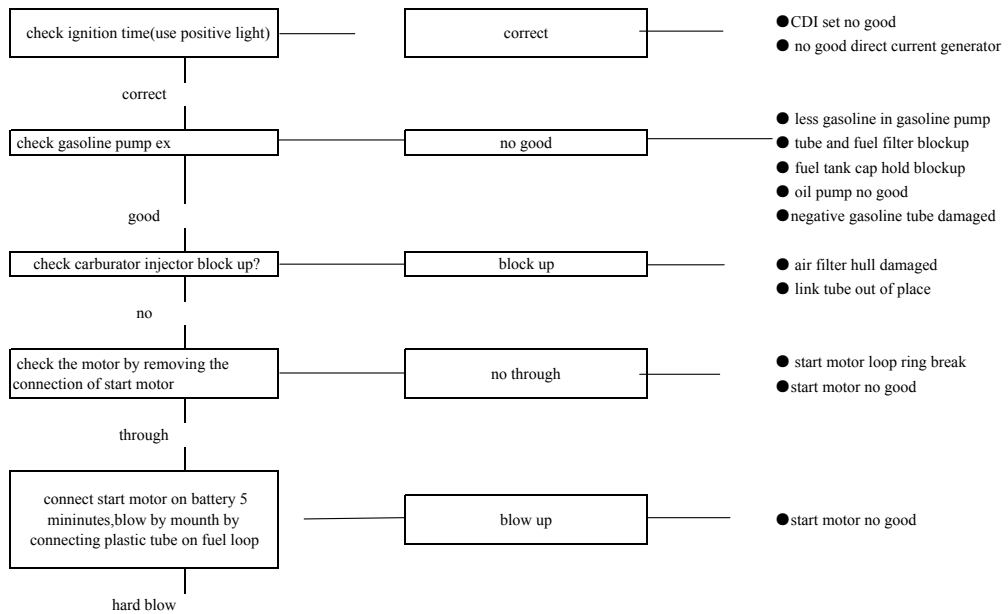

no spark

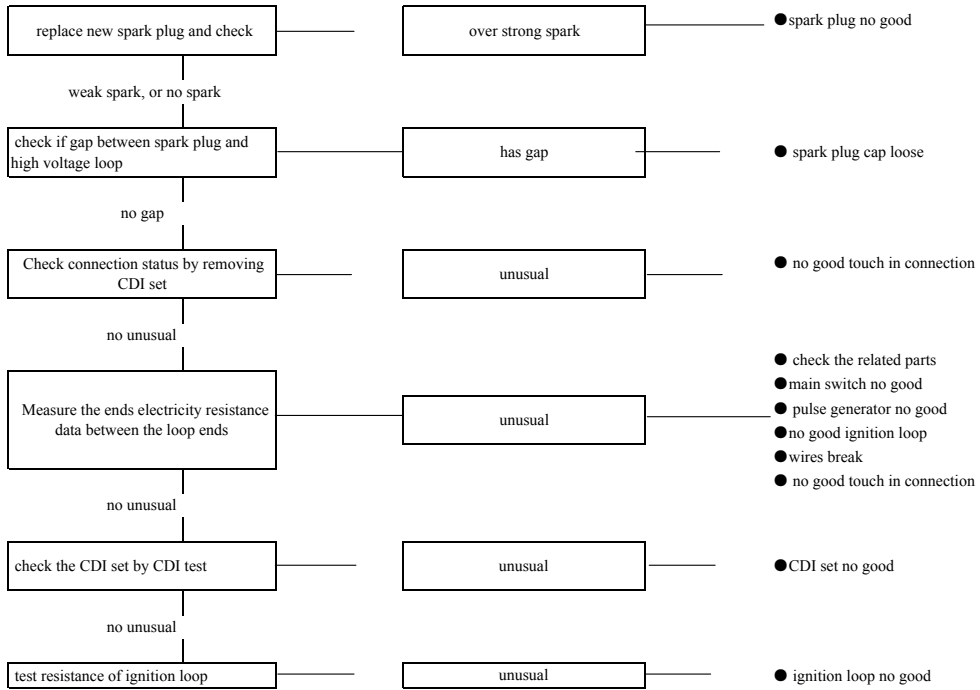

no good charge (battery out of electricity or over charge)

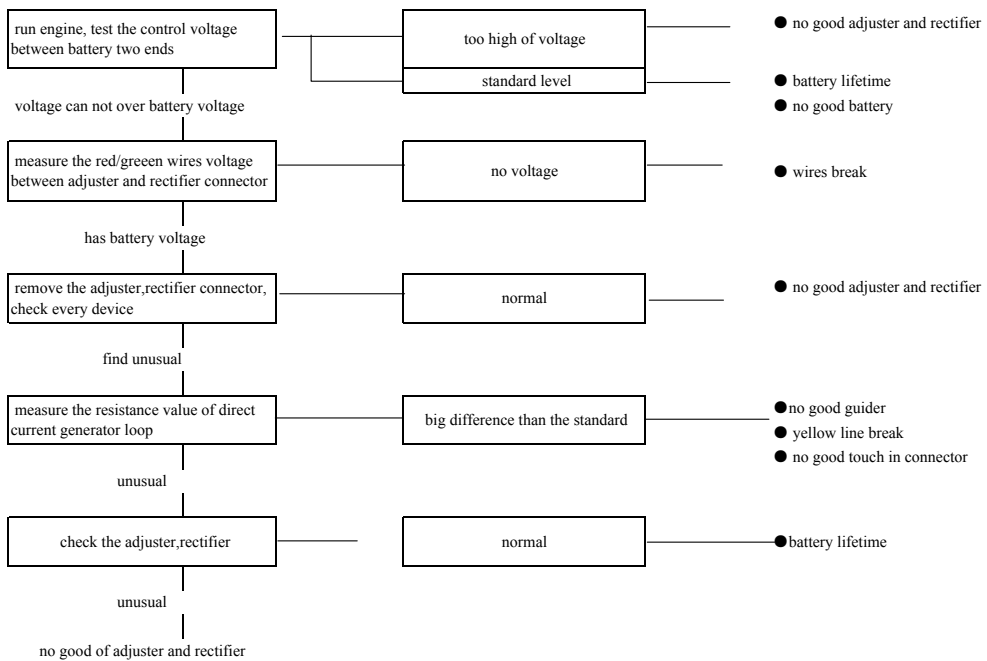

NAC12 Inspection & Adjustment

Methods of inspection & adjustment

Notice: 1. included detecting in high speed in inspections

2. “●”marks the executed time by requested, “○”marks the proposed time by manufactory

3.“☆”marks parts needs to be replaced in periodic time, the time points to motorcycles in common running not to some special cycles in special time

then it will be adjusted following the status of travelling changed

4. " high speed" and " in high speed" mark the speed reaches or over 80KM/ h

(inspection/adjustment/ item)			inspection/adjustment time				remark
			before start	first month	since new		
					every half year	Per year	
Steering							
steering device	handle bar	journey/ degree of tightness/ deflexion				●	
		operating rightness				●	
	F. wheel	steering angle in left or right				●	
	Steering fork.w	fork/brake piston status			●	●	
		damage			●	●	
Deflexion of the fork/piston bearing deflexion					●		
Brake Device	Braking pedal	Pedal measure & mechanical status	●				
		Brake setup status		○	●	●	
	Soft tube	leakage/damage/install status		○	●	●	
		replace brake soft tube					☆ every 4 years
	Brake cup/ flume	liquid capacity	●		●	●	liquid level : R-wheel: between max. and min. limited.
	Wheel & Brake Caliper	enginery/abrasion/damage					
		replace disc brake caliper , dustproof ring rubber parts					☆ every 2 years
	Disc brake and brake abrasion plate	gap between disc brake & brake attrition plate				●	
		brake attrition abrasion/harm			○	●	
		disc brake abrasion/damage				●	thickness standard F-wheel 4mm R-wheel 4mm usage limit F-wheel 3mm R-wheel 3mm
brake liquid	Replace brake liquid					per year	
electric set	Ignition device	spark plug status			●	●	electrode gap of spark plug: 0.6-0.7mm
		replacing spark plug					per 5000KM
	battery	joint status of touch pot				●	
	wiring	joint part in loose or harm				●	

(inspection/adjustment/ item)		inspection/adjustment time				remark													
		before start	first month	since new															
				every half year	Per year														
Wheel Device	wheel	air pressure of F-Wheel & R-wheel	●		●	●	(Unit: KPa) <table border="1" style="margin-left: auto; margin-right: auto;"> <tr> <td></td> <td>前轮</td> <td>后轮</td> </tr> <tr> <td>1人乘车</td> <td>225</td> <td>225</td> </tr> <tr> <td>2人乘车</td> <td>250</td> <td>250</td> </tr> <tr> <td>轮胎规格</td> <td>90/90-18</td> <td>130/90-15</td> </tr> </table>		前轮	后轮	1人乘车	225	225	2人乘车	250	250	轮胎规格	90/90-18	130/90-15
			前轮	后轮															
		1人乘车	225	225															
		2人乘车	250	250															
		轮胎规格	90/90-18	130/90-15															
		chap/damage of wheel	●		●	●													
		tire slot deep & unexpected wheel damage	●		●	●	remaining slot deep: F-W 0.8mm R-W 0.8mm												
		Check if metal /stone/others on wheels	●		●	●													
tightness of axle nut & wheel bolt			●	●	Keep F-w axle & R-w nut F-w axle: 55-65N.m R-w axle nut 55-65N.m														
rim、 section of rim damage	○			●	rim swing F-w landspace swing less 2.0mm, stand swing less 2.00mm R-w landspace swing less 2.0mm, stand swing less 2.00mm														
deflexion & loose of F-w axle				●															
deflexion & loose of R-w axle				●															
Cushion Device	shock absorber spring	damage			●														
	suspension pole	joint loose & pole damage			●														
	shock absorber	leakage & damage			●														
install part deflexion				●	●														
Transmission Device	clutch	handling distance			●	●	10-20mm from handle to end of handle												
		function		○	●	●													
	shifter	oil leak & oil capacity			●	●	oil capacity: between in max. & min. limit of oil measure guage												
		deflexion of control set				●													
	oiling	replacing gear-oil box					every two years												
	chain& chain sprocket	tightness of chain		○	●	●	In the middle of F/R-wheel chain sprocket, the largest swing is 15-25mm												
chain sprocket installation status & fixed & wear					●														
Engin e	noumenon	fix status & strange noise			●	●													
		low speed & accelerate status		○	●	●	idle speed: 1200±100r/min												
		exhaust status			●	●													
		filter parts status			●	●													
	lubricate device	oil smudge & oil capacity			●	●													
		oil leak			●	●													
		oil capacity	●																
		filter block status				●													
oil pump status		○		○															

(inspection/adjustment/ item)			inspection/adjustment time				remark
			before start	first month	since new		
					every half year	Per year	
E n g i n e	fuel device	fuel leak			●	●	
		link rod of carburetor status				●	
		throttle & air valve status				●	
		fuel filter block status				●	
		fuel capacity	●				
		replacing fuel soft tube					☆ every 4 years
	cooling device	water capacity	●		●	●	
		water leak	●			●	
		radiator enginery				●	
		replacing cooling fluid					every 2 years
Lighting device		function			●	●	
indicator		illume/dirty/damage	●				
lock device		function				●	
rearview mirror		reflect status	●				
reflector & chasis VIN no. license		dirty/damage	●				
Odometer		function				●	
Exhaust-pipe & muffler		fix loosen & damage status				●	
		muffler enginery				●	
Chasis		loose & damage				●	
other		inject lubricating grease of chassis status			●	●	
		clean out carbon in firebox and exhaust-pipe					○

Steering Device

Steering fork

Uplift the front wheel, check the fork flexible or deflexion by turning it up down and left-right sides

If deflexion up down side, check the bearing of the steering axle, replace it when problem

If deflexion left right side, check the handle bar and the fork to avoid by twisted by the cable, wires.



bearing of steering axle

Braking device

Braking pedal

Routing

please draw out the gas first when you find the gas mixed into the braking system after testing the braking handle , rear brake pedal.



pushing pole

locknut

Adjust the pedal height

Loosen the fixture nut of the rear brake pump, turn the pushing pole to adjust the height of the rear brake pedal. Double check the running of rear braking light please re adjust it if necessary.

Liquid cup

Liquid capacity

Check the braking liquid capacity

If you find it lower than the min. limit line,

pls take away the septum of the front brake pump cover, circle the rear brake pump cup cover, affux the liquid to max. line.



pump cover

Attention:

- . Do not mix the dust and water inside when filling in the liquid
- . Do not use the non-appointed liquid to avoid the chemical problem.
- . Watch the liquid NOT to erode the paint, plastic & rubber. Do not defile the part
- . When checking and supplement the liquid, please keep the level



liquid cup

Brake disc, brake plate

wear of the disc brake

Check the abrasion of the disc brake and brake plate

Right replace it when over limit



limit slot of abrasion

Attention

Should replace the brake plate in set.

Check the slippage wear or damaged

Replace the brake liquid

Should replace the brake liquid once per year



limit slot of abrasion

Wheel device

wheel

air pressure of the tires

Attention

Must test it after the tire turns cold

Specified air pressure

(unit: KPa)

	front	rear		
1 person	225	225		
2 persons	250	250		
Tire spec	90/90-1	130/90-15		

Loosen of the wheel nut and bolt

Should check the loosen status of the both wheels nut

Tighten them if necessary

Torque:

Front wheel nut: 55~65N.m

Rear wheel nut: 55~65N.m



wheel nut

Cushion device

Suspension

Leakage, damage

Hold the front wheel brake handle, Press hard the suspension fork repeatedly, check its function.

Check the oil leakage, loosen, damage instance



Press the rear suspension repeatedly, check its function

Check the oil leakage, loosen, damage instance

Gearing

Clutch

Distance of the clutch handle

Should check the distance of the end clutch handle

Distance: 10-20mm



Main methods-loosen the locknut of the controller location plank, adjust it by turning the nut.

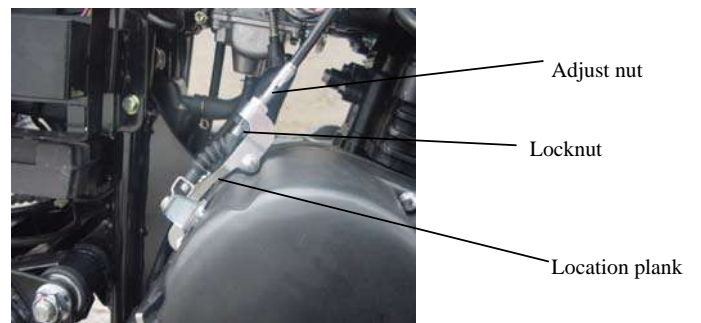

Adjust slightly close to the clutch handle.
pls refer to the right drawing.

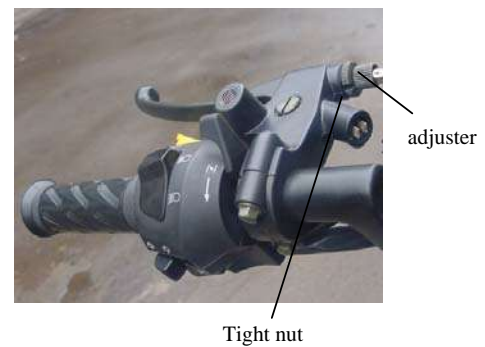

Lubrication Device

Oil leakage and measure oil capacity

Attention

- Uprightness the motorcycle when checking the oil measure
- Run the engine 2-3 minutes, then re-check it after cutoff

Do not insert the measure deeply to check the capacity
please fill the recommend oil until max. limit from the
sprue if oil is low.

Recommendation oil: SAE10W/40 API SG oil

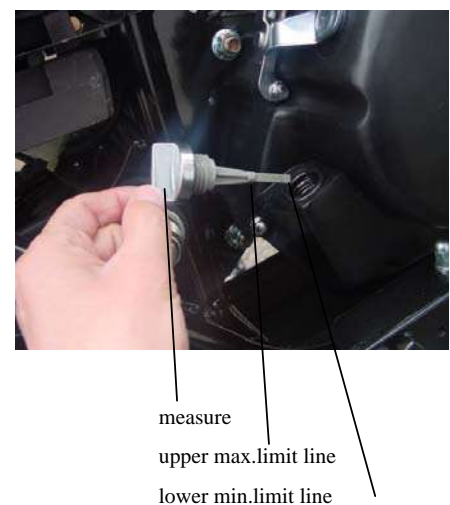

How to replace the oil

Should replace it until the engine is warm up.

release the oil by loosening the oil-exit bolt

please fill the recommended oil from the sprue

tighten the bolt by using the 3.0-4.0kg.m torque

oil capacity 1.9L

Suggest to replace once every two years



oil-exit bolt

Sprocket wheel and chain

Warning

cut-off the engine when checking

Should replace immediately when finding the chain abrasion, damaged chain roller, losing in lock track.

should cut off the engine, neutral it, and hold the motorcycle

Please check the tolerance of the distance between two chain sprockets.

Tolerance: L 15-25mm

Loosen the rear wheel axle nut, move the adjusting nut.

Please check the symmetry left and right sides after adjusted.

Tighten the rear wheel axle nut, torque: 55-65 N.m



Chain tolerance: 15-25mm

Engine

Low speed and accelerated status

Attention

Adjust the idle speed by warming up the engine

Please adjust the carburetor after disassembled and repaired

concurrent with the carburetor itself.

.Start the engine

.Make the engine in "neutral" shift, turn the throttle screw

to the stated data.

Idle speed: 1200 ± 100 r/min

If non-steady idle will cause the rotational creeping problem, so it needs to be adjusted as well.

1200 ± 100 r/min



Idle speed adjuster bolt

Air filter core status

Please disassemble the left side cover

loosen the bolt, take the core out.

Clean the core if found very dirty; replace it when damaged.

put the core back to the box of air filter, tighten

the bolt

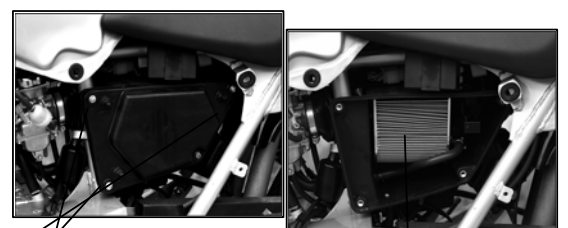

tighten bolt

Core

Fuel device

Status of the control fuel throttle cable

Check its sensitive of the fuel throttle cable
 Turn back the grip around 2-6mm space

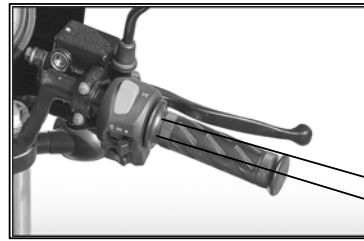

2-6mm

Adjust the distance on the carburator
 take off the cover of the carburator, adjust the
 nut to control the distance



Adjuster nut

Tighten nut

Adjust the distance on the control cable
 Loosen the fixture nut, adjust it by the adjuster



adjuster
 tighten nut

Check the damage or bent status of the handle tightwire
 Check its smoothly while opening or close



handle

Adjust it on carburator
 Loosen the clip, adjust the location of the tightwire



tightwire clip

fixture bolt

Jam in the fuel filter
 Open the fuel switch, check if it is jamed,
 replace the new one if necessary.
 Tighten the nut, torque 20~25N.m



filter screen

Engine knock down, installation

Knock down the parts according the following (1)(2)(3)steps
 Installation please make the orders conversed.

(6) accelerator and clutch wires

(10) clip hoop

Fixture bolt

(3) 2nd air supplement pipe(left & right)

(2)spark plug cable (left & right)

(4) thermostat in

Fixture bolt

(5) ex hose of radiator

(1)exhaust mufflers

carburat

(11) connection plug of right cover

(8)left side cover

(7) shifter

(9)untie the chain

Installation Engine front side: washer2, screw cap2
 Rear side: washer2, screw cap2

Fixing torque: 20~30N · m

Cylinder head, cylinder, piston, valve system

Maintain manual

checklist

Check item	request		List	
	DD244	DD247	DD244	DD247
Cylinder inner diameter	44~44.01mm		44.10mm	
Piston outer diameter				
Piston pin outer diameter	12.95-13.00			
Piston pin hole outer diameter				
Gap of piston ring side				
Gap of piston ring				
Thickness of piston ring 1				
Thickness of piston ring 2				
Free distance of inner valve spring				
Free distance of outer valve spring				
Outer diameter of valve in				
Outer diameter of valve ex				

Torque

torque on both bolt heads on cylinder head : 18~22N·m

— **Engine knock down, installation** —

1. carburetor

Loosen the clip bolt on carburetor, the carburetor can be taken off. When installation on carburetor, please make the intake towards the manifold, then tighten the clip bolt.



Clip hook

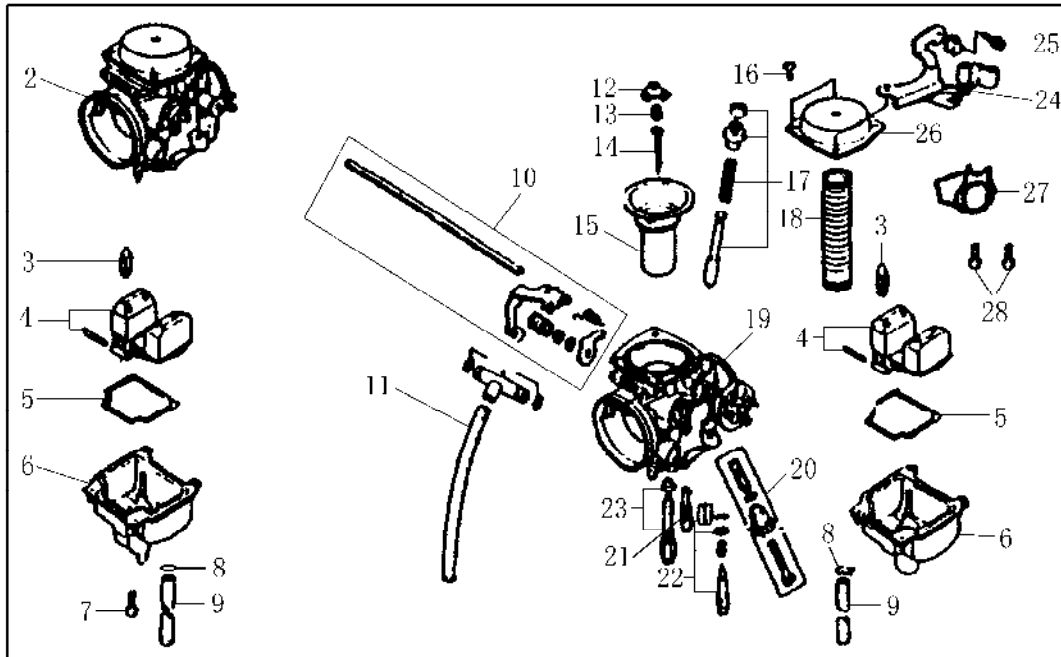

- 1.Carburetor, assy. 2. Left carburetor comp. 3. Float pin. 4. Float set. 5. Gasket, float chamber. 6. Chamber set, float. 7. Screw M4×14. 8. Clip, tube. 9. Over petrol tube. 10. Starter control rob comp. 11. Connecting petrol pipe comp. 12. Limited plate. 13. Spring. 14. Pin, petrol. 15. Vacuum piston valve. 16. Screw M4×8. 17. Starter thicken valve set. 18. Reset spring. 19. Right carburetor comp. 20. Screw set. 21. Jet, slow. 22. Jet, main. 23.screw set. 24. Frament. 25. Screw M4×10. 26. Vacuum piston valve cover. 27. Decorative cover, carburetor. 28. Bolt M4×6

Engine knock down, installation

2. Magneto knock down and installation

remove the left crankcase cover, take off the crank bolt, remove the flywheel(do not knock the flywheel while removing, when install the flywheel, follow the slot and the crankcase end). Please refer to drawing E2.

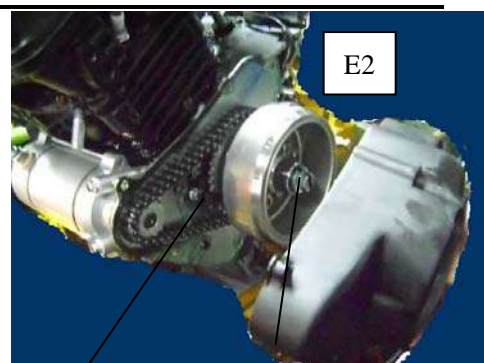

Crankcase bolt

Left crankcase cover

Note:

- Check if any dust inside
- do not knock by sinker
- Install torque for crankcase bolt is 60~65N·m

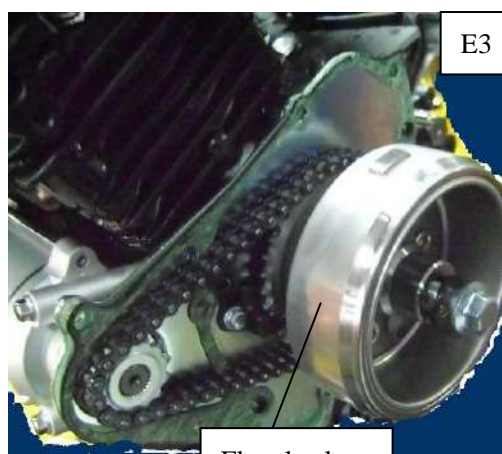

Fly wheel



By special tool to disassemble

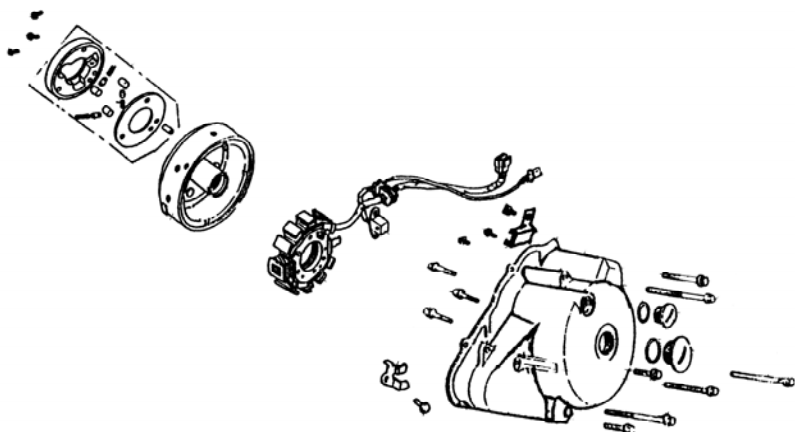

Engine knock down, installation

3、Rocker base

Take off the two impact bolt on cylinder head cover, remove The cylinder head cover.

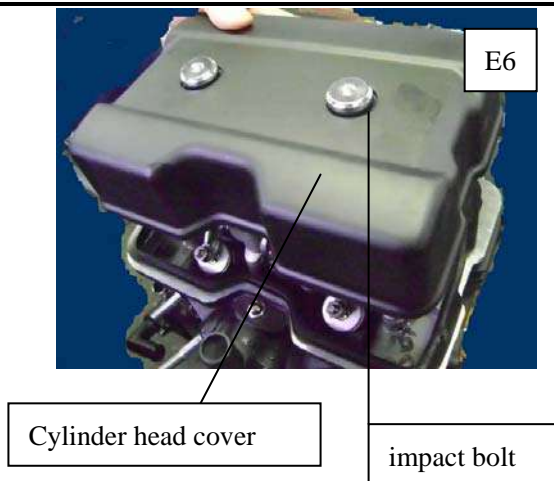

Remove the tensioner bolt, take down the tension

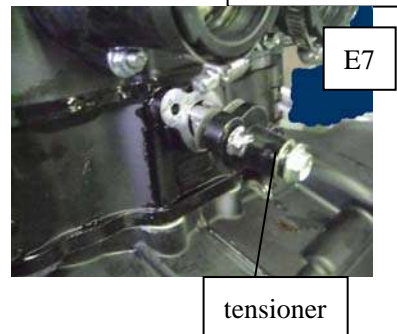

Remove the 8 nuts, take off the rocker base
Torque of the 7 nut is 18~22N·m
Gap between valve : (cold) in valve 0.05~0.07mm;
exhaust valve 0.06~0.08mm

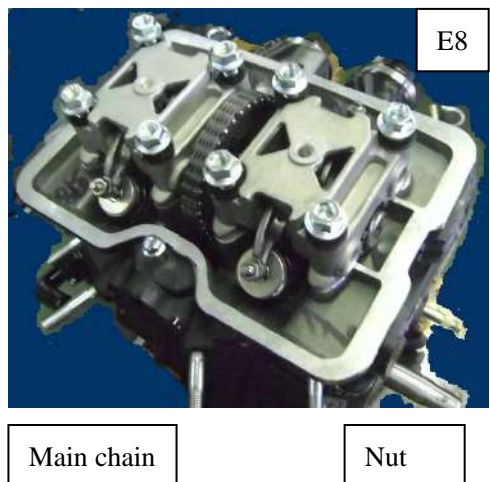

4、Camshaft installation and disassemble

remove the main chain and sprocket wheel,
take out the camshaft

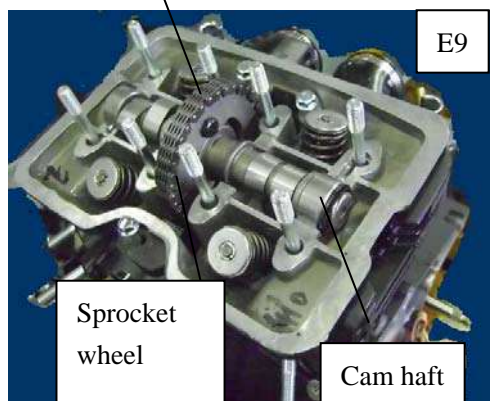

Engine knock down, installation

Note:

When install the sprocket wheel and camshaft; piston is located at the end of compression stroke , please refer to drawing E10 at right side, the reticle at positive time of sprocket wheel is flat aligned with the cam platform of cylinder head.

please refer to drawing E11, the reticle of flywheel should be alignment with the threaded slot of the left cylinder cover.

the pin of the shaft sleeve of camshaft should be set into the pin slot,



Shaft sleeve Flat align

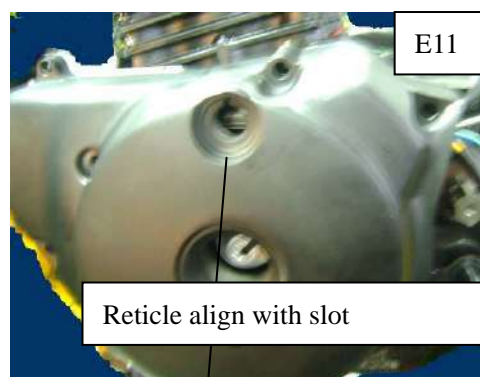

Reticle align with slot



bolts

5、Cylinder head remove and installation

Remove the cylinder head by taking out the camshaft,
Disassemble the bolt on cylinder body and cylinder head
When installation, do not forget to put the washer ,
Oriented pin and O ring



Upper washer of cylinder body

Cylinder head

Oriented plank

Cylinder body

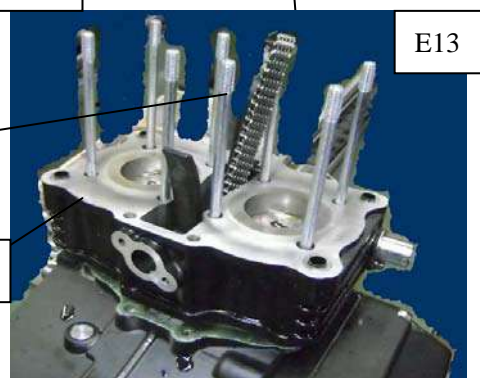

E13

Engine knock down and installation

6、cylinder body

Cylinder head can be removed by removing the cylinder head, take the oriented plank out.

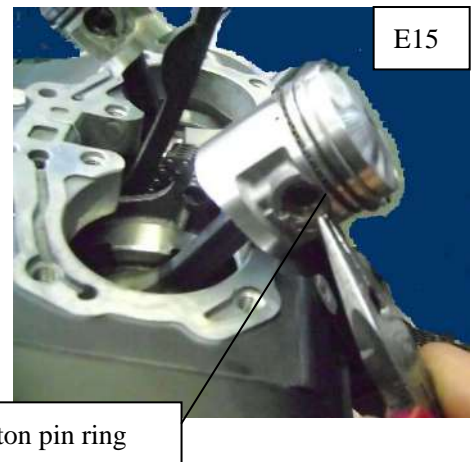
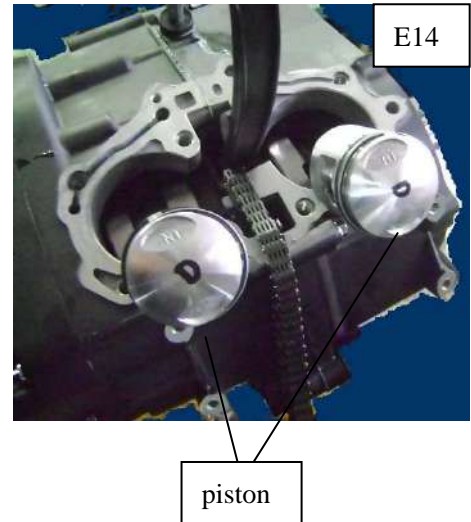
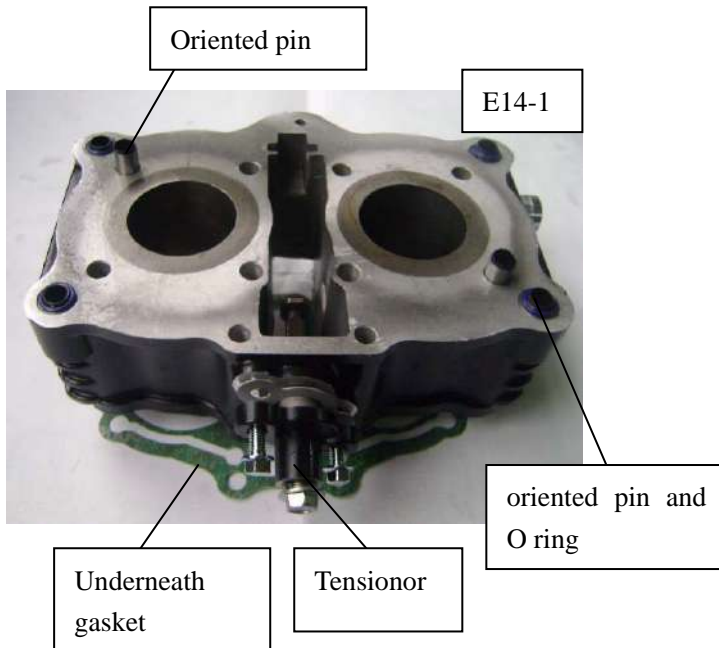

Remove the piston pin ring (E15) by pincer, push out the Piston pin, Remove the piston out.

When installation, please block the intake by clean cloth To avoid the ring falling down into the cylinder body. The "IN" mark means intake



7、

Clutch

First please exclude the oil in the crankcase, remove the right crankcase cover

When installation the right crankcase cover, pay attention To the same direction of the water pump spindle and the Oil pump spindle and do not fall down the ex-oil pipe (E16, E17, E18.)

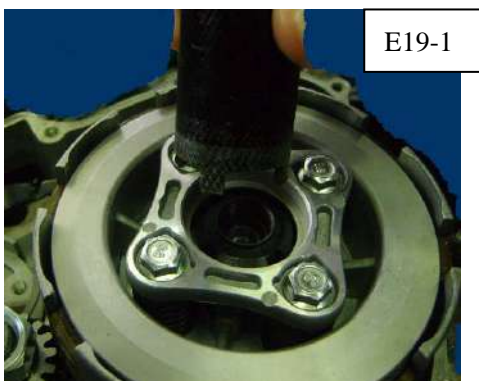

Engine installation and disassemble

Remove the hexagon nut, primary transmission gears, remove the clutch pusher tray, remove the clutch by special tool (E19-1, E20). Before installation, check the scar and color of clutch friction. Replace it when necessary. Please make sure that the smaller round nut end outwards by using the torque 50-56N.m

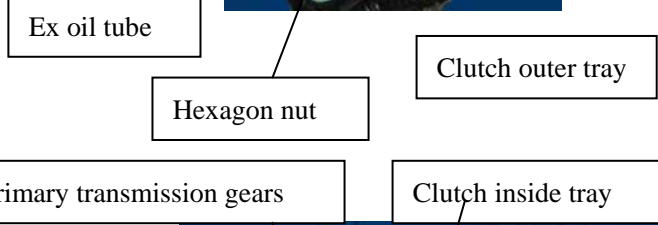
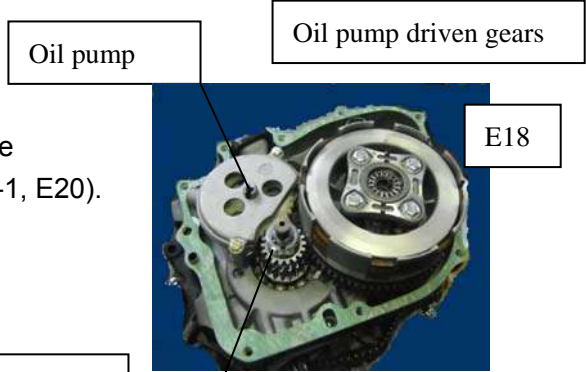

8. oil pump

Remove the oil pump(E18), pay attention to the O ring, please clean the Filter screen before installing the oil pump, and also the O ring

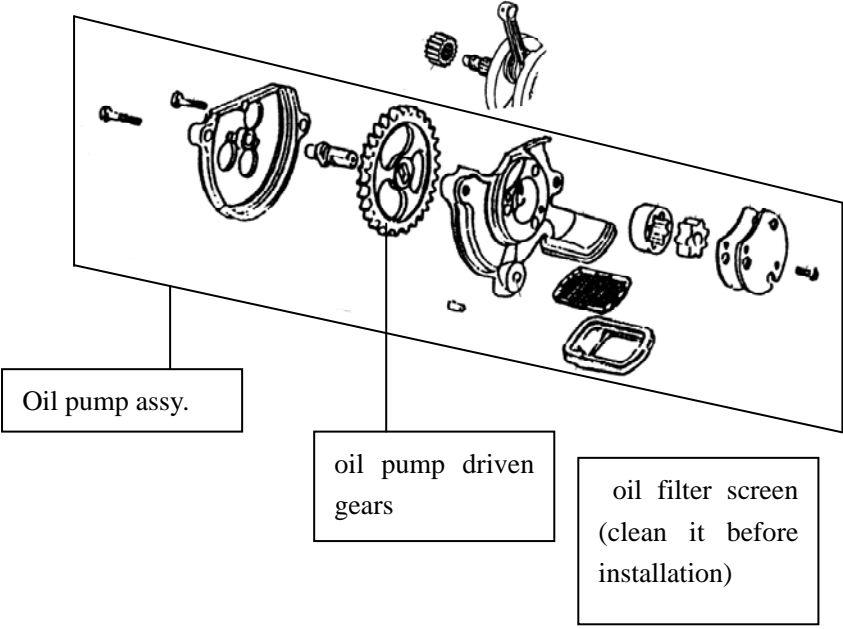
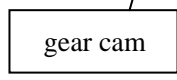

9、 shift gears installation and disassemble

Remove the gear supporting roller, gear cam in turn, take out Gear shank, loose the mounting bolt, remove the right crankcase

(drawing E21 , E22)

Note: turning spring of gear supporting roller should be in right place ; the gear cam pin should be aimed at when installing the gear cam.

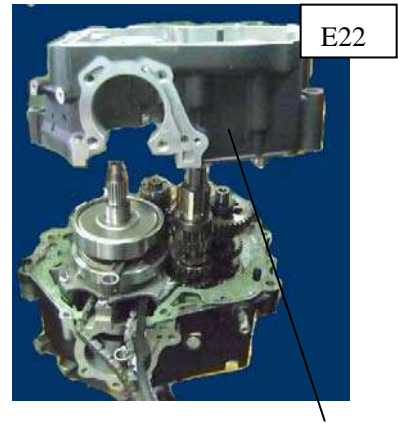

Right crankcase

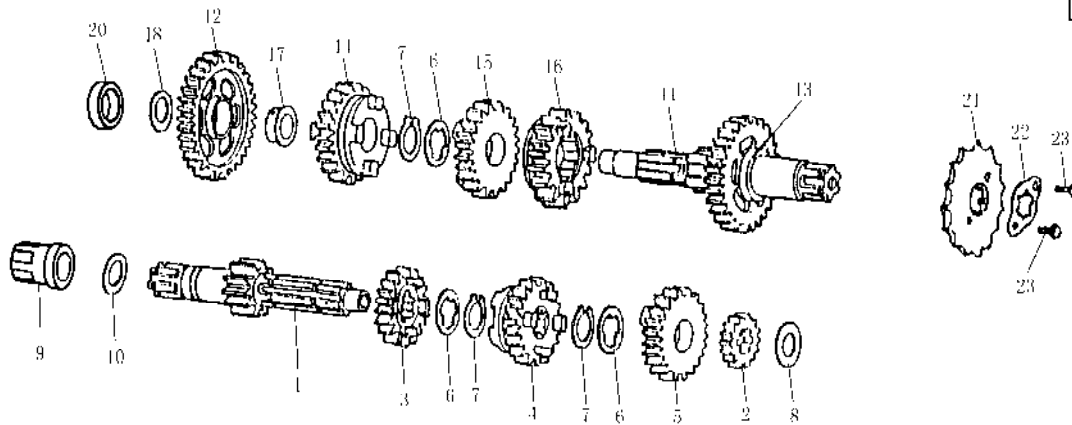

- 1. Mainshaft comp 2. Gear, mainshaft second 3. Gear, mainshaft third 4. Gear, mainshaft fourth 5. Gear, mainshaft fifth 6. Washer ,spline 7. Set ring 8. Washer 9. Shaft bush spline 10. Washer thrust 11. Countershaft comp 12. Gear, countershaft first 13. Gear, countershaft second 14. Gear, countershaft third 15. Gear, countershaft fourth 16. Gear, countershaft fifth 17. Bush 18. Washer 19. Collar (A) 20. Collar (B) 21. Sprocket, counter shaft 22. Plate, fixing 23. Bolt M6×10/ZnD

Mainshaft comp

Gear fork、 gear fork shaft

10、 crankshaft installation and remove

remove mainshaft set, side shaft set, gear fork, gear fork shaft and cam shift kettle, loose the crankshaft mounting bolt, then the crankshaft could be taken off.

Please clean the mainshaft and sideshaft before installation. Pay attention not forget to put the washer



Side shaft set

cam shift kettle

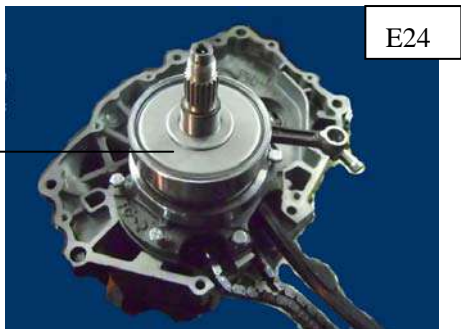

Crank shaft

11、 Engine lubrication system chart

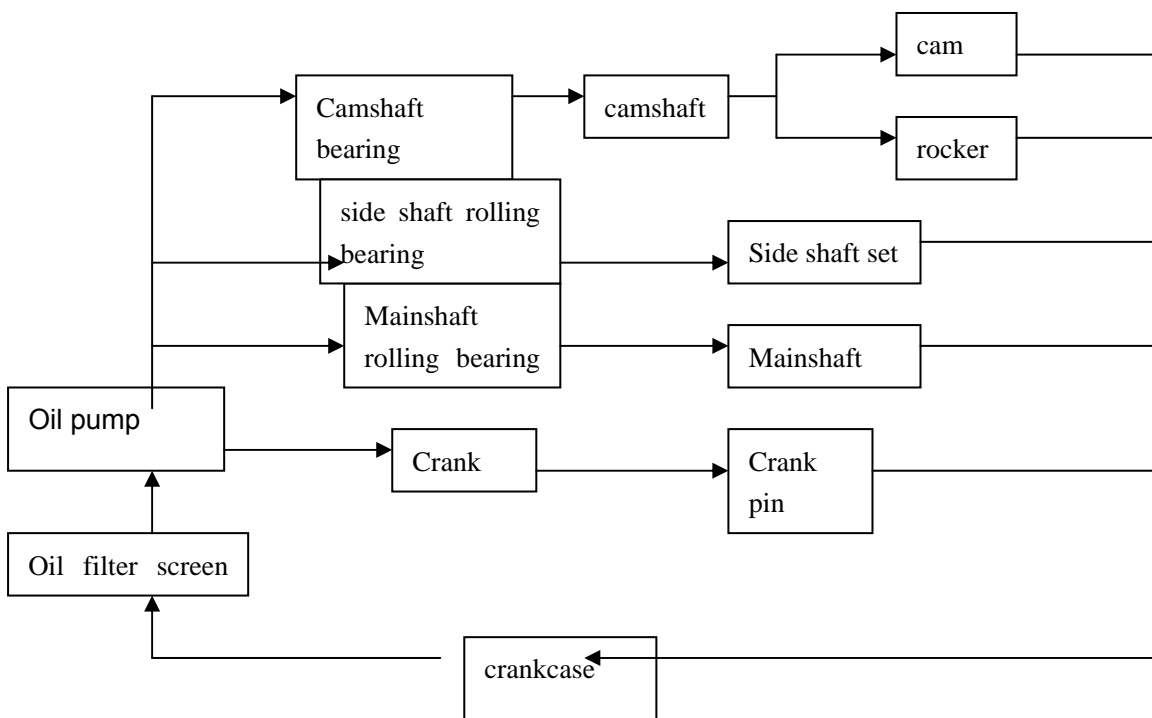
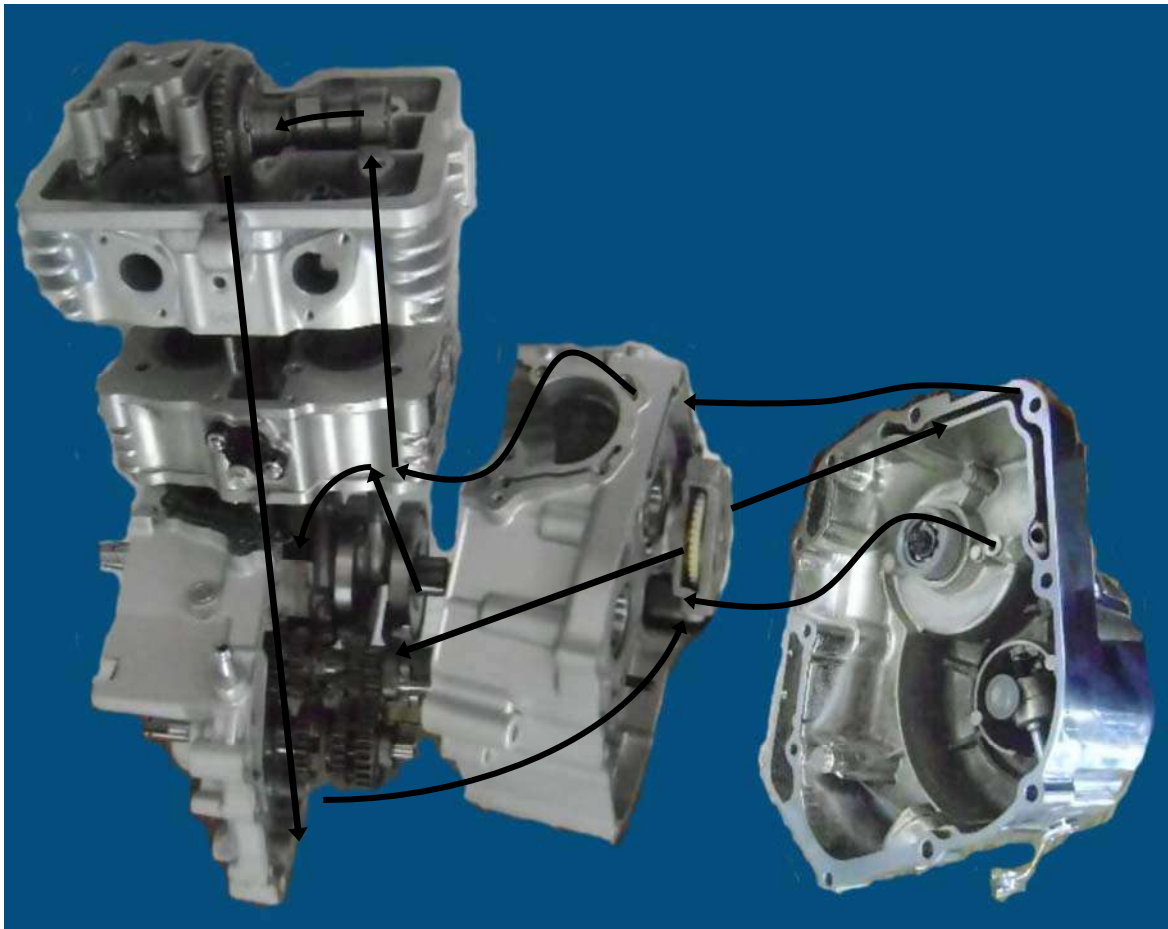

12、 engine cooling system chart

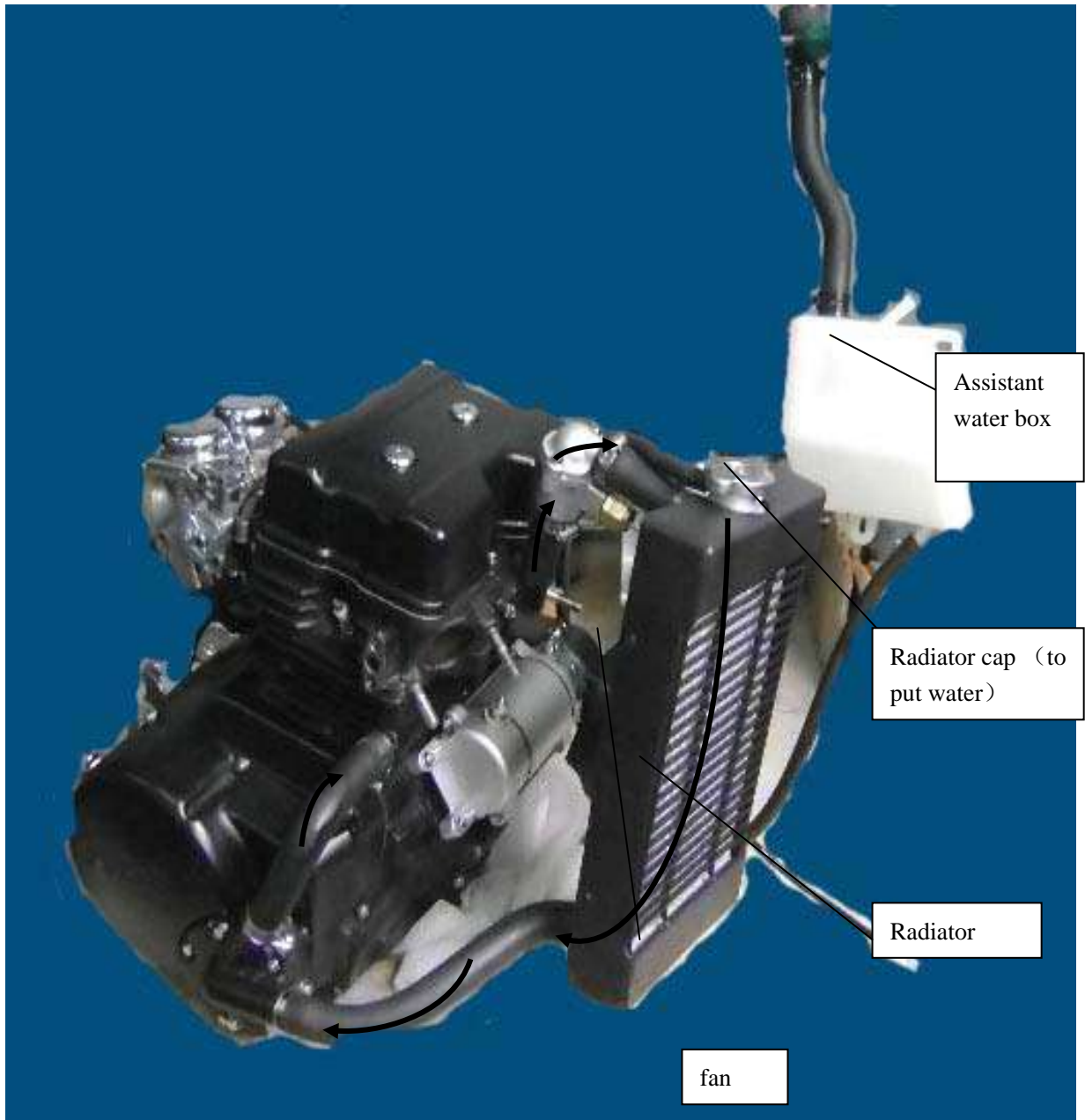

water pump breakdown chart:

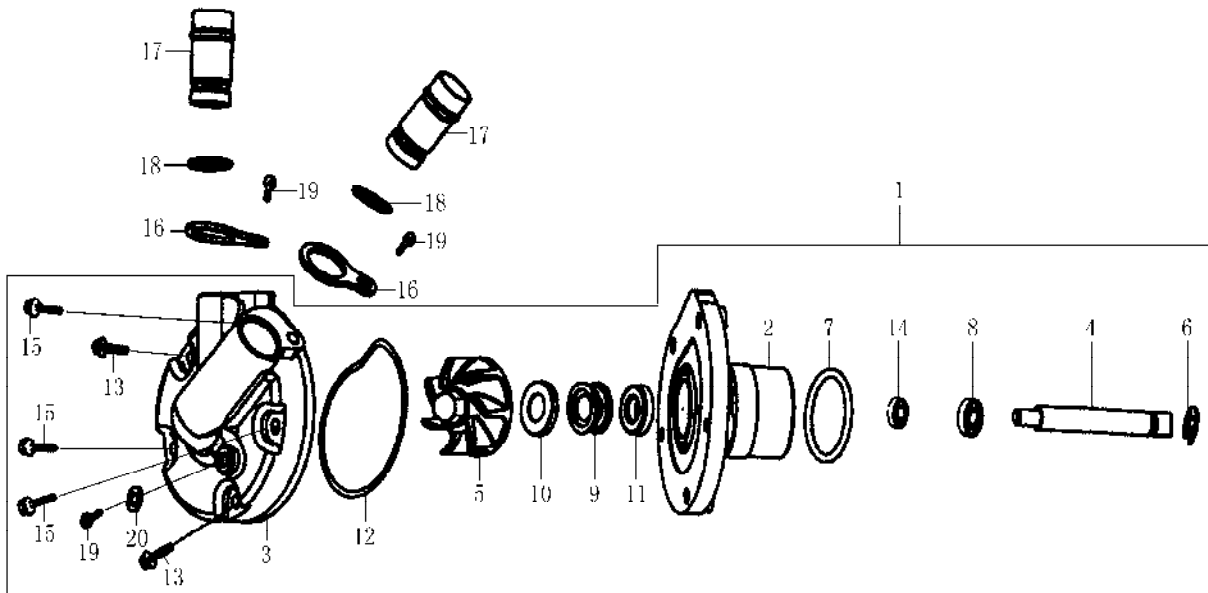

- 1 Water pump comp 2. Water pump hull 3. Water pump cover 4. Water pump shaft 5. Fan
6. Retaining ring 8 7. O-ring ϕ 36x2 8. Bearing 6200 9. Water seal A 10. Water seal B 11.
Oil seal 21x10x5 12. O-ring of pump cover 13. Bolt M6x30 14. Bearing 6000 15. Bolt
M6x40 16. Hose connector setting plate 17. Hose connector 18. O-ring ϕ 17x1.8 19. Bolt
M6x12 20. Washer 6

ENGINE MAINTAIN

Oil filter how to change

Remove the right crankcase cover, loose
The 3 oil pump bolt, remove the whole oil
pump,
Open the oil pump rubber , clean the oil filter

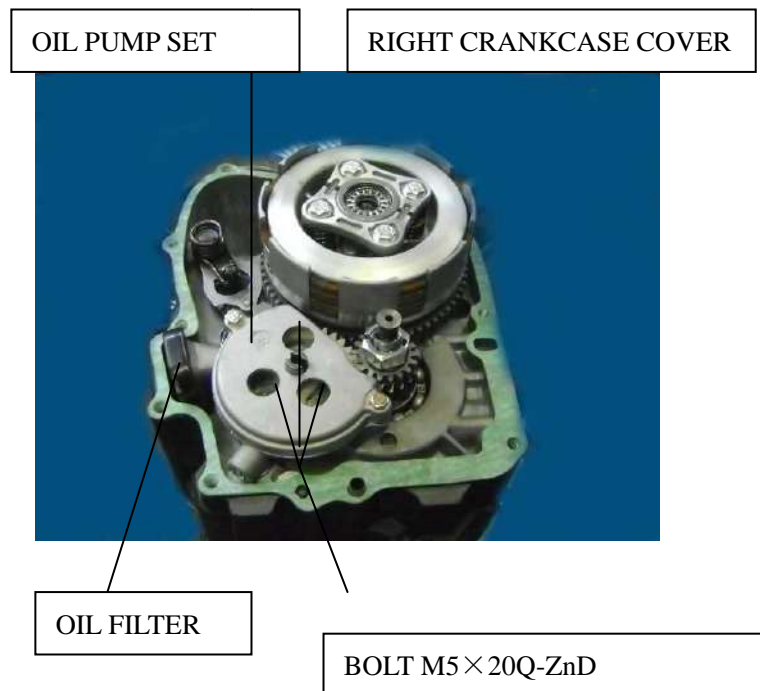
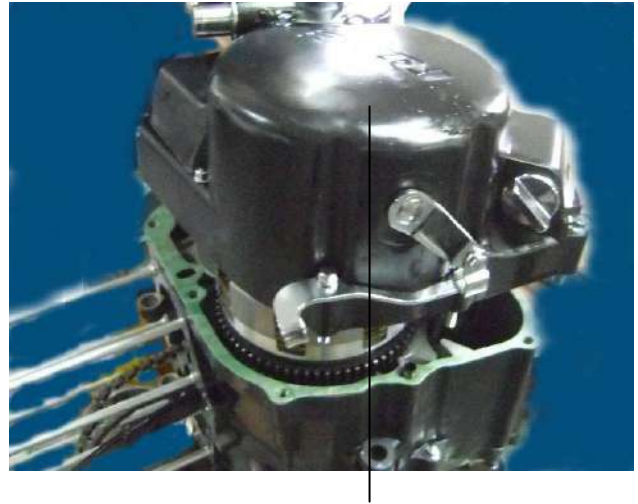

Electric device

Free maintain of battery , no need to check its liquid capability, and no need making up distilled water, Yusa battery need to be inspected and make up liquid

Take off the battery from the motorcycle and can be recharged even the liquid lid is closed.

No need urgent charge for battery unless emergency happened

please follow the requested time and electric current in the instruction when charging battery

No need to adjust the ignition time because of the CDI fire setting. In case the ignition is unnormal, please inspect CDI parts and battery, please replace the parts immediately if problem

Starter motor can be disassembled and installed during the engine is loading

Faults Diagnose

voltage low

lacks battery voltage

plugs connect is not sensitive

charging system poor work

voltage regulation and rectifier poor work

un steady electric current

poor connection of battery

poor connection of charging system

poor connection of ignition system or short circuit

poor connection of charging system

fuse open circuit

poor connection of insert plug, open circuit or short circuit

voltage regulation & rectifier work

generator poor work

start motor poor power

· less charged on battery

· poor connection of lead wire

· others in motor or gear wheel

Engine does not work while start motor is okay

· start pinion poor work

· start motor works in reverse

pointer of fuel gauge unsteady

· plug loosing

· combination parts in bad condition

· meter failure

fuel gauge pointer failure

· connect plug failure

· wiring harness breaks off

· bobber acts failure

· meter failure

· meter poor work

battery

Battery disassemblable and fixing

loose fixture bolt on left side cover, remove the left side cover

no spark by spark plug

· spark plug damage

· poor connection of circuit wire, open circuit or short circuit

· ignition switch poor work

· ignition wire poor work

· CDI damager

· generator poor work

start motor does not work

fuse turn off

· battery less charge

· ignition switch poor work

· F/R brake switch poor work

· start relay poor work

· poor connection of lead or short circuit

· start motor poor works

· start switch poor work

engine runs unnormaly

· ignition system stair loop

—— ignition loop poor work

—— poor connection of circuit

—— poor connection of main switch

ignition system second loop

—— ignition loop poor work

—— spark plug damage

—— ignition loop damage

—— high voltage cap creepages

Ignition time

—— generator poor work

—— guide system poor fixing

—— CDI poor work

light dim

· battery discharge

· over resistance of layout and switch

headlight can not be changed to high beam or dipped headlight

· switch poor



fixture bolt

remove parts in turn

- strap
- fixture bolt
- positive/negative wire
- battery

Note

Please disconnect the negative wire before the positive wire
When installation, do it coverseely

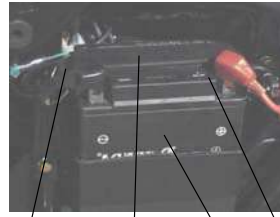

positive wire strap battery negative wire

charge

connection method : positive side of charger connects the positive of battery
negative side connects the negative of battery.
charging current: less 0.9A



Notice

Forbiden fire nearby battery
on and off of charging must be controlled by onoff of charger, to avoid ignition fire damageu
when disconnect and connects

Check on charger system

take off the terminal of battery, measure the voltage between of positive and negative terminal in battery
completeness charge: 13.0 to 13.2V
poor charge: less 12.3V

Regulating rectifier

system test

cut regulating rectifier

Check the plug parts loosed or corrosion

Test items as following

positive direction: connect

	pointer (positive)	pointer(negative)
1	yellow line	green line
2	red line	yellow line

negative direction: not connect

	pointer(negative)	pointer(negative)
1	green line	yellow line
2	yellow line	red line

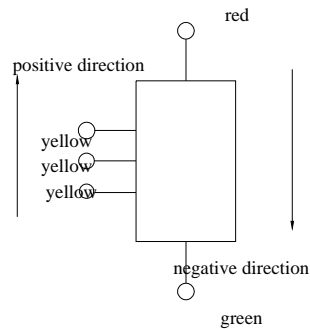

CDI Inspection

loop system inspection

remove fuel tank

romove plug from CDI assy., test it on wiring harness



original loop

item	test point	standard scale
ignition switch	black/white- green	on ignition switch, no connect
ignition loop		turn on light onoff, not guide
original loop	double ends	0.36~0.4 O
inferior loop	green- lead of high voltag	3~3.4 KO



inferior loop

check on fuel supplying system

remove fuel tank

let bobber move up and down fully, test the resistance in each ends

end parts

lead end	bobber location (upper)	bobber location (down)
green-yellow/white	6~10 O	94~108 O



location (down)



location(upper)

Check on ignition switch

remove the plat handle bar and the brackets for odometer

Remove plug of ignition switch , according to the drawing of electric layout to test if it is got through



belt on ignition switch

Replacement

Replace it when the ignition switch does not work

remove the brackets and remove the kickstand and inset parts

remove the fixture bolt ; remove fastness bolt and on/off of light fire installation way is the in opposition method of disassembly as fix



switch plug

Check on handle bar

(refer to the chapter 10)

remove the cable plug of the handlebar on/off, check if each ends are connected if any problem, please check them according to the right next drawing.

Function list of the left on/off

Function list of the right on/off

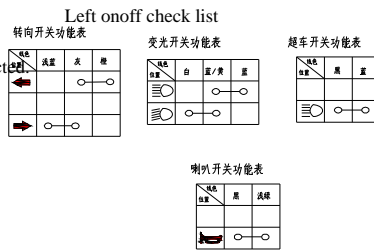

please check them according to the right next drawing.

right on/off check list

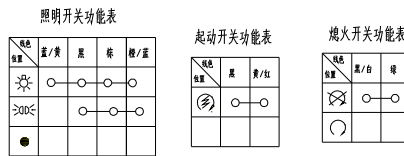

Neutral on/off

Remove the plug of the engine ex wire, test the connect between the light green

In neutral: connect
others: not connect



Engine ex wire neutral wire(light green/red)

clutch on/off

remove the connection loop of clutch on/off

Try the clutch bar, check the connection between in two end parts

hold hard of the clutch bar: connect
release clutch bar: no connect



clutch bar

clutch on/off ends

Rear brake light onoff

remove the right side cover, remove the plug of the braking onoff
Try the rear brake peg, check the connection between two leads
step on the rear brake peg: connect
release the rear brake peg: not connect



plug of rear brake onoff leads

Front brake light onoff

remove the connection loop of brake onoff
try the brake bar, check the connection between two leads
hold hard of the brake bar: connection
release the brake bar: no connection



Brake bar

brake onoff leads

Replace bulb

Headlight

remove the fixture bolt of the front light
take the front light from the lamp cover



fixture bolt

remove the bulb holder (remove lamp holder of headlamp)
replace the bulb if necesse replacing lamp if possible



bulb

bulb holder

Installation procedures is conversed than the removing procedures.

Note

Hold the bolt to the bolt slot in the front light
collect the wires after installation

Odometer light

remove the bearing nut
loosen the fork nut and the fixture bolt of handlebar
loosen the fixture bolt on flat handlebar
take out the handle bar
remove the flat hanldebar and odometer



bearing nut

fixture bolt of handle bar

fork nut

take out bulb holder, and replace new bulb

installation procedure is conversed as the removing procedures



bulb holder

Cooling system

● failure diagnose

● water temperatur rises too high

- (1) check if calculator or heat sensor problem
- (2) check if radiator cover problem
- (3) check if thermostat problem
- (4) check if not enough coolant
- (5) check if the water pipe or water pipe cover is blocked up.
- (6) check if the radiator slice is bent or out of shape
- (7) check if the water tank is blocked up.
- (8) check if the water pump is problem

● water temperature no up or difficulty in rising

- (1) check if temperature meter and related parts is not good
- (2) check if thermostat is not good

leakage

- (1) mechanism seal problem
- (2) the aging of O ring , seal not good
- (3) the aging of soft dome water pipe damaged.

● Maintain Notice

● Notes

The maintain on cooling system can be adjust on the motor. However, the water pump parts need to be removed.

The maintain must be under the cold engine. It is dangerous to open the radiator cover when it is hot then you must wait until the temperature goes down.

if the coolant touches the paint, it would corrot the painting. So you must wash it by water immeidately.

After inspection and maintainance, please check the connection and seals to avoid leakage.

● Maintain standard

Item	standard value
fan switch general temperature	88°C
sensor general temperature	125°C
cooling water content	full around 1.6L(water bottle around 0.4L)

Notice of usage coolant:

You must use the 3500 anti-rust & freeze liquid if suppling the coolant. Do not mix with the other coolant harmful of coolant, do not drink it.

do not open the radiator cover when the engine is in hot

● Radiator

● remove of the radiator

Remove the water release bolt, please eject to the clean content.
Loosen the clip hoop after the coolant is ejected
remove the water pipe



water release bolt clip hoop water pipe

remove the fan motor and inductor connection

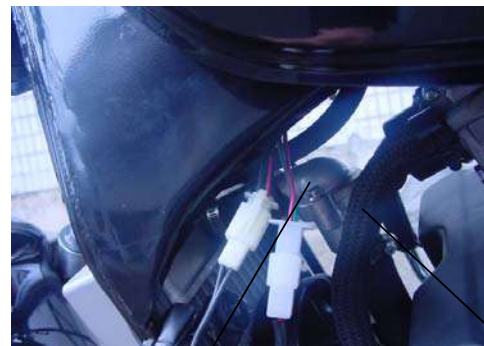

sensor plug fan motor plug

Remove the 4 fixture bolt
Dismove the radiator cover from the chasis



fixture bolt radiator cover

Loosen the clip hook of thermostat water pipe
loosen the clip hook of the water bottle hosing, and
depart from the radiator



water pipe hosing clip hoop of thermostat clip hoop

Remove the upper fixture bolt and lower fixture bolt
remove the radiator

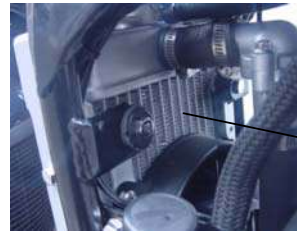

fixture bolt



do not damage the cooling fin

● radiator breakdown

remove the 2 bolts, take out the fan completely.

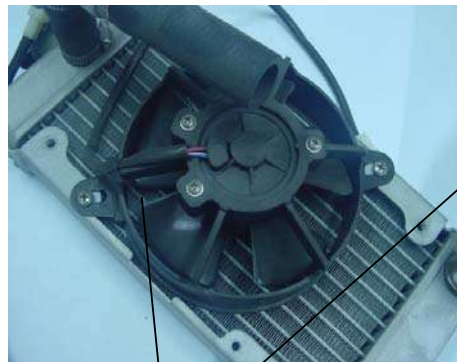

fixture bolt

please screw out the sensor, loosen the fan switch
sensor nut

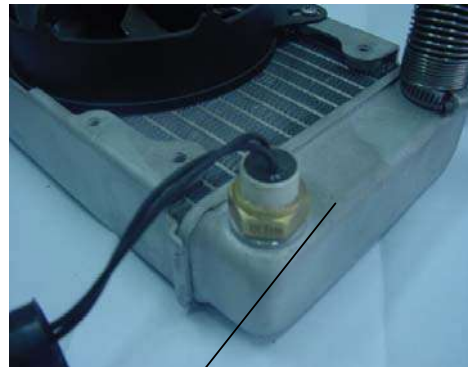

fan switch sensor

● check on fan switch

please put the fan switch sensor to a testing case,
heat it to 88°C, then measure the heat sensor resistance
at that time the fan switch heat sensor is connected.



fan switch heat sensor

● **Check on the radiator and soft pipes, etc.**

check the core of radiator blocked up or not, the cooling fin is bent or not
please adjust it by a screwdriver



if the block is 20% than the total cooling area,
please repair the radiator or replace it immediately.

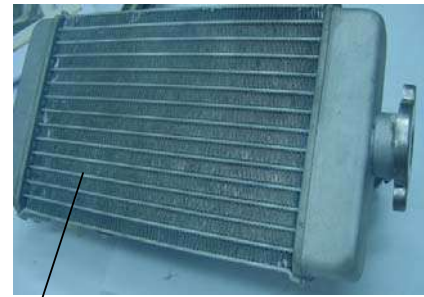

cooling fin

check if the soft pipe and its clip is aged and damaged

Installation of radiator

please install it conversed procedures as knock down
inject the coolant(refer to chapter 3)
check any leakage on the soft pipe, every connectors,
lower of water pump

● **thermostat**

remove the thermostat
eject the coolant(refer to the last chapter)
fold the senser wire



sensor wire

Loosen the clip hoop of the water pipe of thermostat
remove the thermostat



clip hoop

● **installation of thermostat**

please install it conversed procedures as knock down
inject the coolant(refer to chapter 3)

● **heat sensor knock down**

take off the heat sensor from the thermostat hull



heat sensor thermostat hull

● **check on the heat sensor**

please put the heat sensor to a testing case,
heat it to 125°C, then measure the heat sensor resistance
at that time the heat sensor is connected.

● **Installation of heat sensor**

wipe the screw antiloose and put it on the thermostat hull.
connect the down-lead

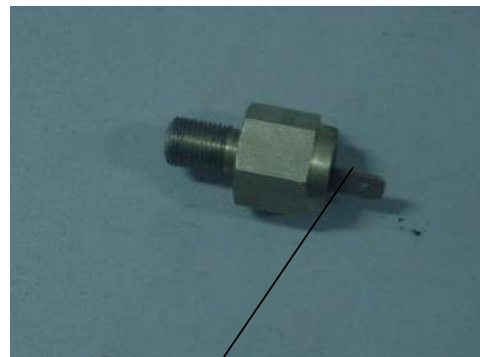

heat sensor connector

● **water pump**

● **check on mechanism seal**

check if any leakage on the testing hole underneath the
water pump. If yes, please replace the mechanism seal

● **Remove the water pump**

eject the coolant



bolt water pump clip hoop water pipe

loosen the clip hoop, remove the soft water pipe from the water pump
loosen the 5 bolts, remove the water pump



Thermostat



1、 open the thermostat cover



2、 take out the thermostat(see arrow)



3、 Pressure seal (remove this rubber seal ring, put it outside of the $\Phi 30 * \Phi 20 * 1$ flat washer)



4、 Please put the seal washer in the hull of thermostat, mount the thermostat cover.

Front wheel, front suspension device, steering device

Maintain information

Notes:

- 1、 Do not press over-load on the wheels and put anything on the wheel. Pay attention not to damage the wheel during maintaining.
- 2、 Pay attention not to damage the tire and rims due to no inner tube inside
- 3、 Please use the special "Off-tire pole" and rim protector when removing the tire out rim and avoid of damaged wheel.
- 4、 Please remove the disc when replacing the tire. Otherwise, please do not load any on the disc plate but hold the rim with the wood board.

Maintain standard

Item	standard	limit
Bent radius of front wheel		0.2mm
jumpiness of front wheel	vertical	2.0mm
	horizontal	2.0mm
Bent radius of fork leg		0.2mm
oil capacity of fork	standard	257ml

Fixture torque

Handlebar mounting bolt	24-30N.m	brake pump mounting bolt	24-30N.m
fork bushing bolt	15-25N.m	steering adjustment nut	23-27N.m
brake disc nut	14-16N.m	braking seat bolt	10-14N.m
fork leg bolt	15-30N.m	steering pole nut	90-120N.m
front axle nut	55-65N.m	clutch seat	7-11N.m

failure diagnose

hard in controlling the handlebar

over tighten on the steering adjustment nut

steering axle damaged

twist when steering by the cables and operating wires.

low tire pressure

Impossible to operate the handlebar

fork bent

front axle bent, tire damaged

rear fork bent

noise in the front suspension

touch on the fork leg and bottom

less oil capacity

loose on fixture parts for suspensions

front wheel shaking

rim out of shape

loose on front wheel axle

tire no good

related mounting parts no well tightened

related to the front wheel axle

balance of wheels no good

too soft of the front suspension

over work on the spring

a little leftover of oil capacity

air pressure of fork no good

no usage of stickness oil

too hard of front suspension

oil no good quality inside the fork leg

no good adjustment of air pressure

fork legs bent

block-up of the oil passageway

no usage of stickness proper oil

Handle bar

remove

dismove the following parts from right handle bar

1. brake pump
2. handle switch
3. fuel accelerater handle grip

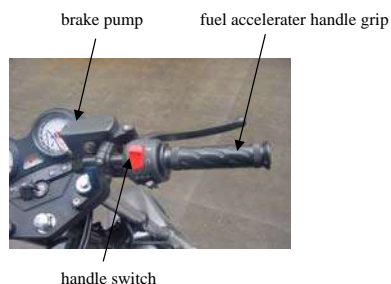

remove the following parts

1. clutch bar holder
2. handle switch

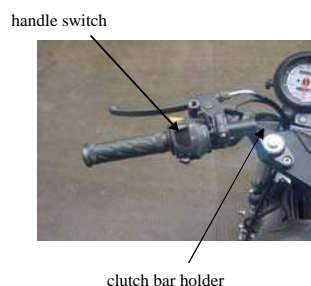

loosen the mounting bolt , remove the handle bar

Installation

install the handle bar on the fork
(make sure that the loop is in the slot of both fork)
mounting bolt fixed is aligned with faceplate

Note

check if the faceplate is well connected with handlebar, make sure the tightness of the loop from up to down side.
if any problem, loosen the steering bolt, move the fork down wards to make it well installed.

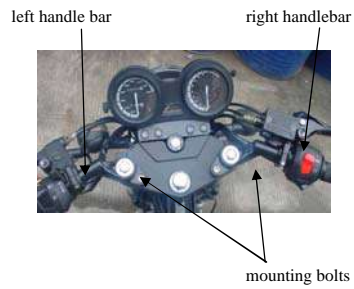

bolt of faceplate

tighten the faceplate bolt
torque : 9-13N.m
tighten the handlebar mounting bolt
torque : 24-30N.m

use the lubrication grease on the slipping side,
then install fuel accelerated grip

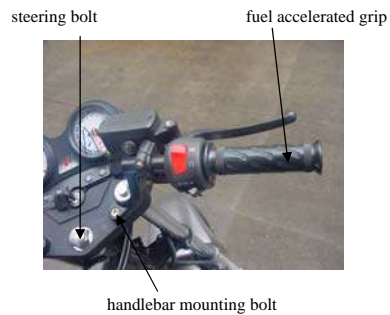

Please insert the fuel accelerated cable into the grip.
alignment the right handle switch convex into the handle bar,
tighten the switch by two small bolts

Note

first tighten the front small bolt, then the back one



fuel accelerated cable

mark the "UP" of the holder, install the brake pump on the handlebar
alignment the handlebar mark and the face of brake pump and holder
first tighten the upper bolt, then the under bolt
torque: 10-14N.m
connect the front brake light switch by wire
adjust the gap of the installed fuel accelerated grip



air valve switch on the handlebar
 clean the dirt or oil grease on the left grip and
 connect side of handlebar



left grip air valve pole

install the air valve operatin cable on the air valve pole
 align the bulgy of left bar switch with the hold on handlebar
 tighten the handle switch by the 2 small bolts

Note

First tighten the frontier bolt, then the back one

install the clutch bar, tighten it by bolt
 torque : 7-11N.m

Note

align the mark with handlebar and the face of bar holder
 "UP" mark face up
 First tighten the upper bolt, then the under one



small bolts UP (mark)

Front wheel

remove
 remove the soft axle bolt , remove the
 odometer soft axle



small bolt soft axle cable

remove the mounting bolt of brake pump
 Hold the front wheel up by holding the chasis
 loosen the front wheel axle nut
 pull the axle out , remove the front wheel



mounting bolt wheel axle nut

note

Do not damage the disc brake and brake plate

Turn the inner ring of the wheel bearing by finger,
 if any loosing gap or noise, replace it

Make sure that the outer loop of bearing is pressed into the rim ,
 replace it when any problem

Note

Replace the bearing left and right together



wheel bearing

Next
 remove the 6 bolt, remove the disc brake

Warning

pay attention to the oil grease. It will reduce
 the braking function
 make sure to remove the grease completely
 when find it.

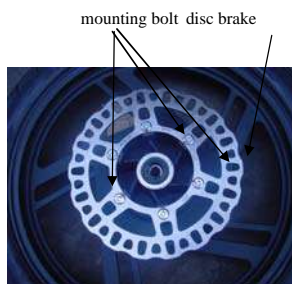

mounting bolt disc brake

Installation

attention

do not touch the brake disc

Install the wheel axle from left side
align the odometer gears with the right side of the left fork ends
put the bushing on the right side, put axle on the rim
tighten the wheel axle , tighten the mounting bolt from left side
torque: 15-20N.m



front wheel axle

Install the wheel axle nut, tighten it.
torque: 55-65N.m
Tighten the right mounting bolt of wheel axle
torque: 15-20N.m

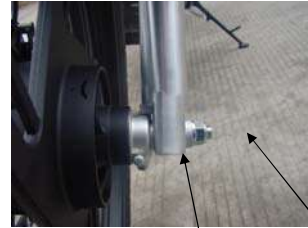

speed gears front axle nut

connect the soft axle of odometer to the speed gears, tighten it by the small screw.
install the brake pump

Note

Do not damage the disc brake plate

Try the brake bar several time in order to check each gap between the brake pum and disc brake

Note

The main reason is because the too small gap between the brake pump and disc brake

Front suspension

Remove
remove the front wheel
loose the brake pump mounting bolt, remove the brake pump

Note

Protect the brake pump by used cotton, put in on the working table.
Do not bend the brake soft pipe after taking out the brake pump, do not operate on the front brake bar

remove the mounting fender bolt, remove the front fender,
remove the brake soft pupe from the front suspension

Note

Do not bend or twist the brake soft pipe



front suspension brake pump mounting bolt front fen

Loose the face plate bolt



face plate bolt

Loose the steering bolt
down wards move the fork leg, remove the fork



steering clamp steering bolt

Note

lay down, caution, do not damage the surface of fork

Installation

Reversed procedure as the remove.

Tighten the face plate bolt
Torque 9-13N.m
tighten the steering bolt
torque : 45-55N.m

steering post

remove
remove the front suspension (see above steps)
remove the nut and washer from the steering post
loose the bolt of face plate, take the face plate off



steering post bolt

washer

loose the steering axle bearing nut
take out the steering post from the chasis stem

Note

Make sure to protect the nut screw threads of steering post
do not damage the steering post



Steering axle bearing nut

remove the dust proof ring
please put the new dust proof ring into the steering post
press the inner ring

Installation

lay on the lubrication grease completely in the chasis stem
replace the new steel ball
install the steering post into the head stem
install the upper bearing

Tighten the steering adjust nut
torque: 23-27N.m
Then tighten the steering adjust nut per specific torque

Note

Repeat turning to left and right 5-6 times after installation if no sensitive, please re adjust the steering axle bearing nut.	
---	--

Rear wheel. Rear fork. Rear shock absorber

● failure diagnose

● rear wheel swing

- (1) rim out of shape
- (2) loose of rear wheel bearing
- (3) poor tire
- (4) poor mounted parts related to the bearing
- (5) less pressure in the tire

rear shock absorber too hard
over oil fluid in the cushion

noise of rear shock absorber

- (1) problem on the rear shock absorber
- (2) loose in the mounting parts

too soft of the rear shock absorber

less oil fluid in the cushion

● Maintain notices

● Notes

pay attention not to damage the alloy rim

Do not damage the tire, rim because of the no tube tire.

to avoid damage the wheel, please use the special tommy bar and wheel protector to remove the tire.

● Maintain standard

		standard	limit (mm)
wheel axle bend radius		—	0.2
jump of rear wheel	axle direction	—	2.0
	radial	—	2.0

● Regualted torque

rear shock absorber (upside)	18-25N.m
(downside)	30-40N.m
rear wheel axle nut	80-100N.m
drive sprocket nut	60-70N.m

● remove rear wheel

hold the motor by jack, take the rear wheel out of ground
loose the rear braking pump mounting bolt, remove the rear brake pump.
remove the rear wheel axle nut.



rear wheel axle nut rear brake pump mounting bolt

loose the adjuster nut
push hard on the adjuster forwards
push hard on the wheel forward to remove the chain out of the chain sprocket



adjuster nut adjuster

Hold the rear wheel up
Remove the rear wheel axle, take the bushing and rear wheel out

Note Do not hang the brake caliper assy by the brake soft tube, you could hang it by tightware or lay down on the table

check on the bent of wheel bearing

wheel bearing bent data

limit: 0.2mm above, please replace asap.

check damage of the rear wheel bearing

turning the rear wheel, if found the bearing boose or noise, pleae replace the new one asap.

check the jump of rear wheel

limit axle direction jump: 2.0 above, please replace
 jump radial side: 2.0 above please replace

the whole style wheel can not be repaired

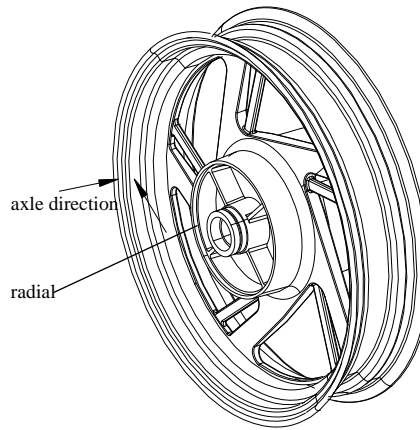

● check the driven sprocket

replace new if the driven sprocket abrasion, out of shaped

Note

meanwhile check the driven sprocket&main sprocket

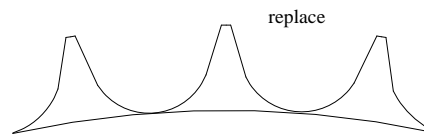
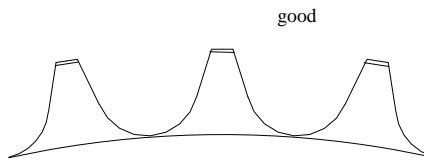

● check the cushion pad

replace the new one if the cushion pad is aged or damaged

● rear wheel installation

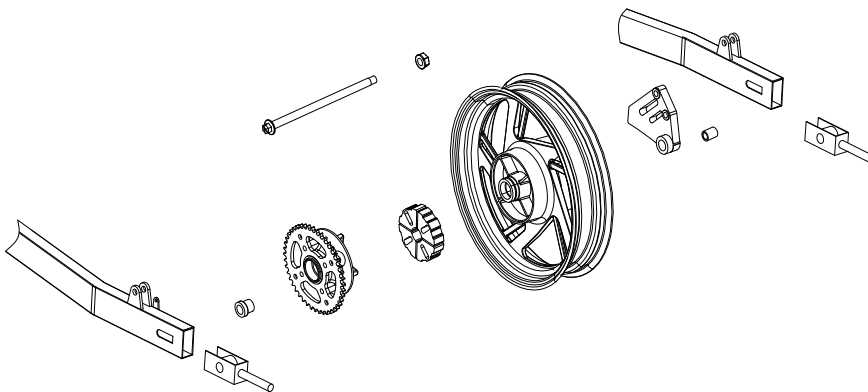

Please install the rear wheel on the rear wheel per above steps

cushion

Note

left side sleeve length is 26, right side is 12, do not mix them
 put lubrition oil on the oil seals and cushion before installation

Adjust the adjuster nut to make sure the proper chain length
(refer to the check and adjustment chapter)



adjuster nut

adjuster

Install the wheel axle nut
Mount the rear disc brake on the mounting plate by bolt

rear wheel axle nut torque: 80-100N.m
bolt torque: 18-25N.m



rear wheel axle nut

rear brake pump mounting bolt

● rear shock absorber

● rear shock absorber

remove the up and down mounting bolt
remove the rear shock absorber from the outside chasis



mounting bolt

Installation
conversed steps than the remove steps.

Note

put the lubrition oil on the rear absorber head sleeve before installation

● check rear fork

Check the rear fork damaged or chapped
check chain protector abrasion or damaged

● remove rear fork

remove the rear wheel and rear shock absorber
remove the rear fork axle nut, remove the rear fork axle



— 49 — rear fork axle nut

rear fork axle

● rear fork installation

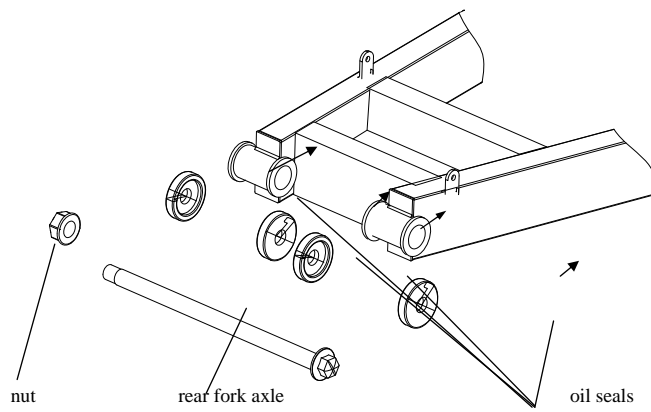

install the rear fork on the chasis , tighten the nuts according the above steps in drawing
tighten nut, regulated torque: 80-100N.m

Install the rear fork and rear shock absorber (see above steps)

Braking system

- 1、 Forbidden to mix dust or water when supplying the brake liquid
- 2、 Do not use the different brand brake liquid to avoid the chemical change.
- 3、 Please use the DOT3 brake liquid
- 4、 No use of the extracted brake liquid
- 5、 Please clean it by cotton material because the brake liquid will damage the paint, plastic, rubber, etc.
- 6、 please well connect the soft pipe end to avoid the brake liquid be outflowed
- 7、 Please clean the removed parts by brake liquid and check the aeration every interfaces by compressed air.
- 8、 Please tidy up the removed parts to avoid of dust and other things.
- 9、 Install the parts after making sure there is no dust on them.
- 10、 Must replace the necessary appointed parts
- 11、 Please disassemble them if you want to replace the brake soft pipes.
- 12、 Please take out the air before removing the brake soft pipe
- 13、 pay attention not to bend the brake.

Item	Standard	limit
thickness of disc brake (rear)	4	3
jump of disc brake	front	0.4
	rear	0.3
Inner diameter of front brake oil pump	12.7	
Inner diameter of rear brake oil pump	12.7	
inner diameter of caliper oil pump	34	
outer diameter of caliper oil pump	34	

poor function of brake

- 1、 mixed with air
- 2、 less brake liquid
- 3、 leakage of brake liquid
- 4、 abrasion of disc slice
- 5、 surface dirty of disc brake and brake slice

brake noise

- 1、 dirt or abrasion of brake slice
- 2、 disc brake swing, abrasion, and dirty
- 3、 poor installation of brake caliper
- 4、 difference between the disc brake and wheels
- 5、 less lubrication on the connection point of brake slice and hanger pin

brake shank difficulty in handling or low function of brake

- 1、 block in piston caliper
- 2、 block in brake system
- 3、 block in main piston

Low function of one brake

- 1、 dirt on brake slice
- 2、 difference between the disc brake and wheel
- 3、 block on the caliper slippage slice

lay down the brake oil pump flatly, check the level of liquid

Note:

- 1、 Do not mix the dust and water when filling in the liquid
- 2、 Do not use the different brand liquid to avoid chemical change
- 3、 Do not damage the paint ,plastic, and rubber
- 4、 Remove the right side cover first before removing the rear storage liquid lid
- 5、 Use DOT3 brake liquid on front wheel , use DOT3 or DOT4 on rear wheel

brake oil pump



remove the cover of extraction valve, lay the pump flatly

install the clear plastic pipe into the extraction valve

loose the brake pump extraction valve, handle the brake bar

repeatedly handling until all liquid has been out from the extraction valve



remove the cover of extraction valve, lay the pump flatly
 install the clear plastic pipe into the extraction valve
 loose the brake pump extraction valve, handle the brake bar
 repeatedly handling until all liquid has been out from the extraction valve

Note

do not make it dirty on the disc brake and brake plate
 replace the brake plate and clean the dirt on the disc brake if necessary

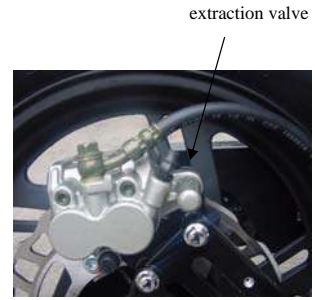

Note

1. please make sure the level of the brake liquid before action
2. if the level is close to the mini. Limit, first please fill in the brake liquid

close the extraction valve, fill in the brake liquid to max. limit.
 put the film



extracting air from the separator by handling the brake shank,
 until no air from the pump

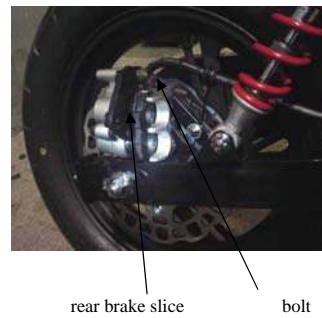

remove

Note

- 1、 Do not damage the paint, plastic, rubber by brake liquid
- 2、 Wrap the connection point of soft tube by cotton to avoid the brake liquid out.

brake oil pump



brake soft tube bolt bolt

- 1、 Extract the brake liquid
- 2、 Remove the brake soft tube bolt, remove the soft tube
- 3、 Remove the braking light wire
- 4、 Remove the soft tube of liquid box
- 5、 Take the liquid box out of the brake oil pump by removing the bolts.



braking light wire

Remove the braking light wires
remove the lid, ring loop, take out the soft tube heads from the pump

install the brake oil pump on the handle bar

note

- 1、 Face up the UP mark at the countermark on the handlebar
- 2、 First tighten the upper bolts

torque: 10-14N.m

connect the braking list wire to the switch
fill in the brake liquid, then extract the air

countermark



seal ring bolt UP mark

mounting bolts of brake pump

brake soft tube bolt

extract the brake liquid

Remove the brake pump mounting bolt
Loose the braking oil tube bolt
Take the pump out
Remove the braking soft tube bolt



Note

do not damage the paint, plastic rubber parts
by the brake liquid
wrap the soft tube heads by cotton to avoid the liquid flow out

check on the disc brake

same disc brake as front and rear
limit: below 3.0mm

Check the gap between disc brake
measure the jump of the disc brake

limit: front disc: below 0.4mm

rear disc brake: below 0.3mm