



**YM 50 GYS**

---

# **USER' S MANUAL**

# **FOREWORD**

Thanks for your purchasing this motorcycle.

With the help of this manual, you will learn the correct procedures of operation and basic knowledge of maintenance and trouble shooting of the motorcycle. It presents all the basic knowledge of maintenance and trouble shooting of the motorcycle. It presents all the details of the performance of this motorcycle to you and the vehicle will make your life more relaxed and happier.

In case any picture does not agree with the vehicle physically, the latter shall prevail.

# CONTENTS

I. Safe Drive .....	1	Adjustment of Throttle Cable .....	15
II. Main Data .....	3	Adjustment of Carburetor .....	15
III. Parts and Subassemblies .....	4	Check-up& Adjustment of Air Valve Gap···	16
IV. Operation .....	7	Brake Checking··········	16
Fuel Cock .....	7	Adjustment of Front Brake .....	17
Engine Starting··········	8	Adjustment of Rear Brake .....	18
Switches on Right Handlebar··········	9	Vehicle Washing .....	20
Switches on Left Handlebar··········	10	Instructions for Storage··········	21
Gear Shifting··········	11	Resumption of Service after storage··········	22
V. Checking, Adjustment and Maintenance··········	12	Table of Torque for fasteners··········	22
Machine Oil Checking··········	12	Resumption of Service··········	23
Renewal of Machine Oil··········	12	Table of Maintenance··········	24
Cleaning of Machine Oil Tank··········	13	VI. Electrical Diagram··········	25
Check-up of spark plug··········	13		
Check-up & Cleaning of Air Filter .....	14		

# I . SAFE DRIVE

## Rules for Safe Drive

Check must be conducted, before starting the engine, to prevent mishaps and damage to components.

Only the qualified person who has passed the drive examination with a drive license is permitted to drive the vehicle but not anybody else without a drive license.

Full preoccupation is required during drive, paying attention to the following points to avoid any possible hurt to you by other motorized vehicles:

Do not drive too close to other vehicles;

Never contend for lane.

Strictly observe the local traffic rules.

As driving at overspeed is the cause of many accidents. Do not drive at a speed that the actual situation does not permit.

Particular care should be exercised at the level crossing of roads, entrance and exit of parking lot or on the automobile lane.

During drive, grasp the left handlebar by the left hand and the throttle twist grip by the right hand, with feet on the footrests.

## Protective wear

1. Protective wear such as helmet with protective mask, dustproof glasses and gloves should be worn during drive for the sake of personal safety.

2. Loose clothes are not suitable for motorcycle drive or ride as they may get caught on the operating lever, kick, footrest or wheel, resulting in danger.

## Modification of the vehicle

### Caution:

Any unauthorized modification of the vehicle or replacement of the original parts can not ensure driving safety and is illicit. The user must observe the regulations of the traffic control authorities, We are not responsible for any vehicle with unauthorized modification.

## II . MAIN DATA

Item	50 type		Item	50 type	
Overall length	1910mm		Cylinder bore x stroke	39×41.4	
Overall width	760mm		Compression ratio	8.8:1	
Overall height	1140mm		Output,max	2.0kw/7000r/min	
Wheelbase	1260 mm		Torque,max	2.2N.m/62500r/min	
Dead weight	92kg		Idling speed	1500r/min ± 100r/min	
Payload	150kg		Displacement of cylinder	49ml	
Front wheel	3.25-18		Spark plug	A7TC	
Rear wheel	3.00-16		Spark plug gap	0.6~0.8mm	
Speed,max	45km/h		Gap of air valve	Inlake valve:0.05mm	
Braking distance	≤7m(30km/h)			Exhaust valve:0.08mm	
Climbability	≥18°		Ground clearance	200mm	
Capacity of gasoline	5.5L		Ignition means	CDI	
Transmission ratio					
1 st gear	3.273	2nd gear	1.937	3rd gear	1.611
4th gear	1.350	5th gear			
Final reduction	3.286				

### III.PARTS & SUBASSEMBLIES

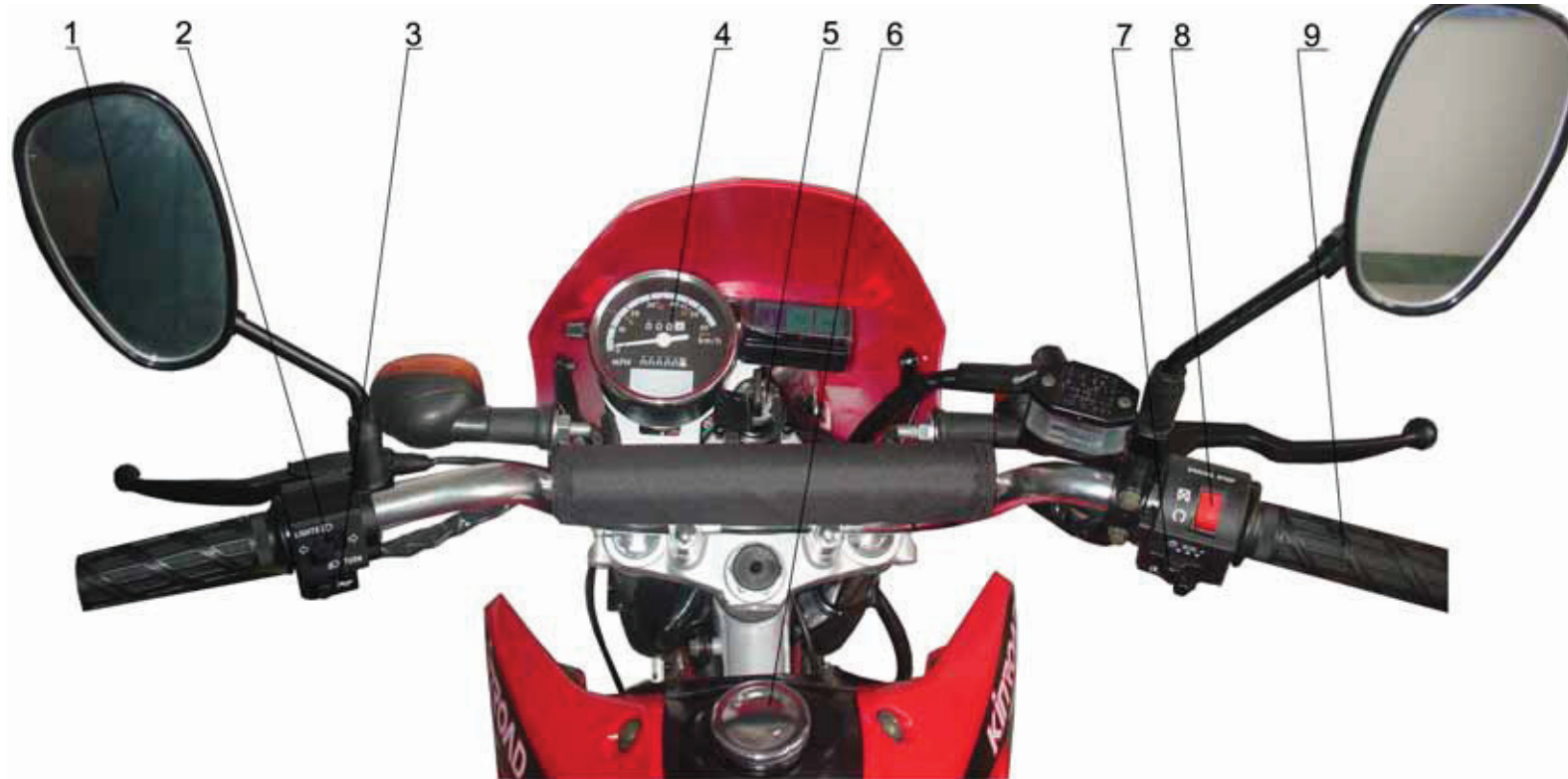

1.rear mirror 2.headlamp control and direction indicators button 3.audible warning devices  
4.meter 5.ignition lock 6.fuel tank cover 7.lighting switch 8.engine ignition or cut-off





1. front wheel 2. front shock absorber 3. fuel tank 4. gear shifting  
5. side stand 6. rear fork 7. rear wheel



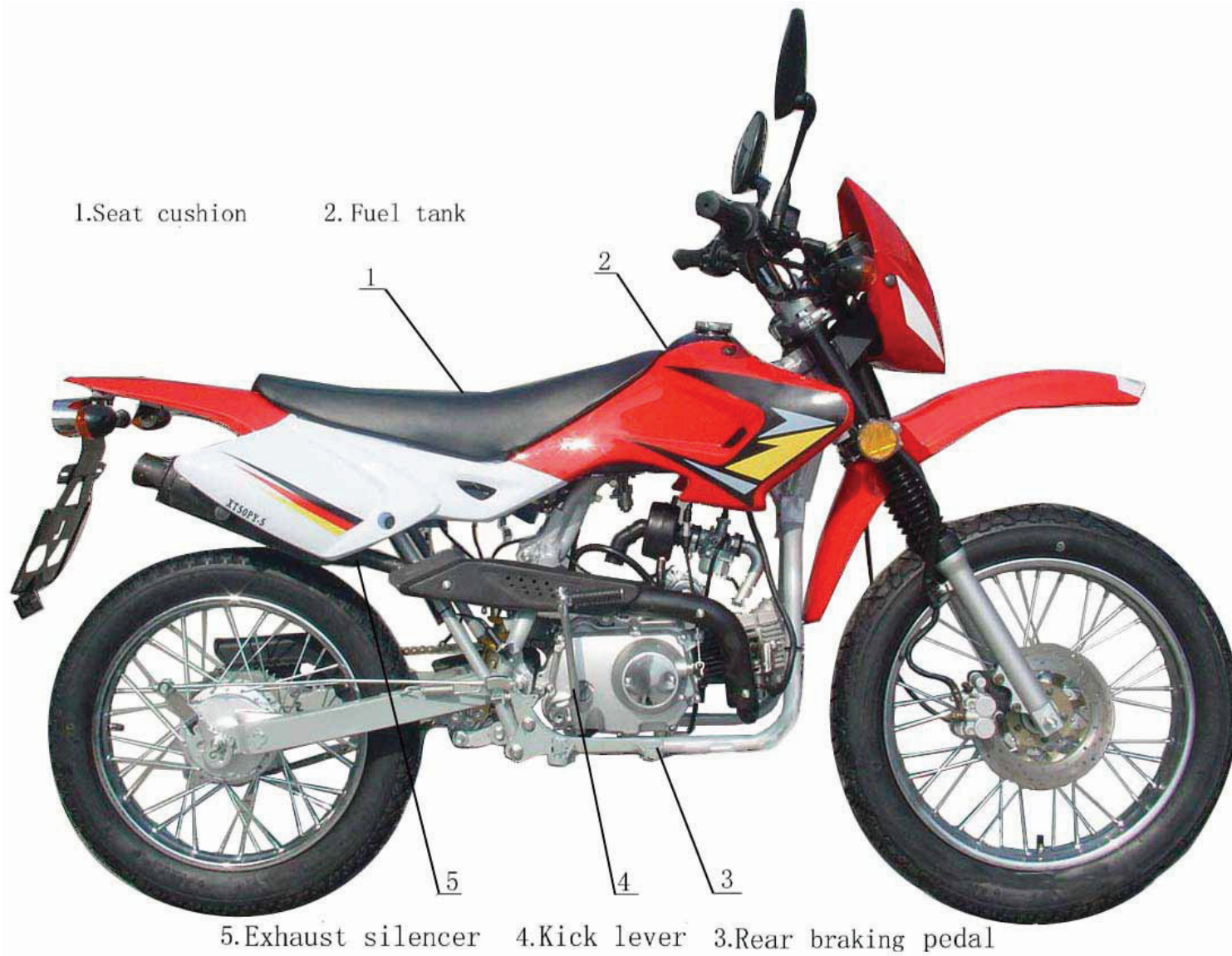

## IV.OPERATION

### Fuel Cock

#### 1.Fuel filling

The capacity of the fuel tank is 4.5L. Leadless gasoline of No.90 or above or low-lead gasoline is required for the motorcycle. To fuel the vehicle, support it by the main stand, open the lock cover of the fuel tank and fill fuel through the opening.

#### Operation of the fuel cock

ON: With the handle of the fuel cock to "ON" position, the fuel circuit is through for fuel supply.

OFF: With the handle of the fuel cock to "OFF" position, the fuel circuit is cut off without supply.

RES: With the handle of the fuel cock to "RES" position, the fuel is supplied from the reserve. (Note: The reserved fuel can

only be used when the normal supply is run out.) In this case, refueling should be carried out as soon as possible; for there is only some 1.0L of fuel reserve for use.

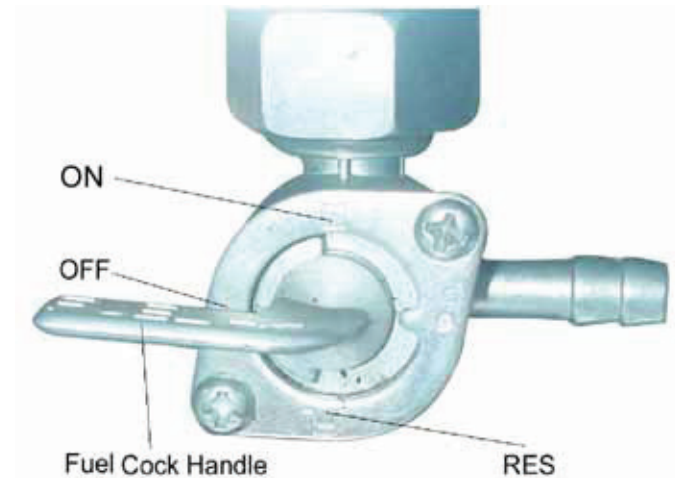

# Engine Starting

Warning: Never start the engine in a closed place or warehouse or warehouse as the exhausted gas from the vehicle contains toxic carbon monoxide.

1. Set the key of the ignition switch to “ON” position.

2. Ascertain the neutral position, where it should be displayed.

3. Ascertain the amount of fuel in the tank,

4. Set the fuel cock handle to “ON” position.

★ To start a cold engine;

1. Pull up the choke bar of the carburetor (to close the choke).

2. Rotate the throttle twist grip by 1/8 to 1/4 turn.

3. Start the engine by the electric or the kick starting system.

4. Slightly turn the throttle twist grip to increase the speed of the engine so as to warm up the engine.

5. Turn the carburetor choke bar downward to fully open the choke when the engine is sufficiently warmed up.

★ Caution:

The engine can only be started after the neutral position is ascertained. Otherwise accident will happen.

Unnecessary idle running (especially at a high speed) is harmful to the engine.

★ Procedures for stopping the engine:

1. Release the throttle twist grip to slow down the engine.

2. Turn to the neutral position.

3. Set the ignition switch key to “OFF” position.

4. Set the fuel cock handle to “OFF” position.

# Switches on Right Handle bar

## Electric start button

The electric start button is located below the right handlebar. When the ignition switch is set in “ON” position and the engine is in the neutral position, push the button to start the engine

## Light switch

The front light switch has three positions,

  And “●”(a white point).

 When the switch is in this position, the front head light button, tail and meter lights are all lit up.

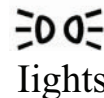
 When the switch is in this position, the tail, betraying and meter lights are lit up.

“●” When it is in this position. The front illuminator, tail, betraying and meter lights are all off.



## Switches on Left Handle bar

### 1. Headlights dimmer button

☰☐ Position, Headlight is in high beam.

☷☐ Position, Headlight is in low beam.

### 2. turning light switch

←☐ position, Left

→☐ position, Right

### 3. Horn button

press this button for horn



## Gear Shifting

A non-cycling mode of gear shifting is employed of this motorcycle

- The throttle must be closed before the gear shifting every time, Shifting the gear before closing the condition of backing it for four times.
- The speed shifting pedal must be operated suitably.
- Stepping on the gear shifting pedal is forbidden when driving to prevent damaging the clutch when changing the gear abruptly.

NOTE (N) Neutral gear      (1) 1<sup>th</sup> gear  
(2) 2<sup>nd</sup> gear                (3) 3<sup>rd</sup> gear  
(4) 4<sup>th</sup> gear                (5) 5<sup>th</sup> gear

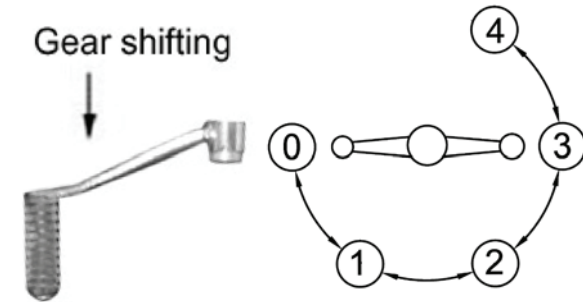

## Points for Attention during Drive

1. Avoid unnecessary idling of the engine and it is not allowed. In particular, to have it idling at a high speed. Other wise it will damage components seriously.
2. Shift to the low speed gear when feeling that the power is not strong enough on climbing.
3. It is forbidden to use the front brake only or to coast by the neutral gear especially when descending or driving at high speed.
4. On braking. Narrow the throttle. and then apply the brake



# V. Checking, Adjustment and Maintenance

## Machine Oil Checking

★The vehicle should be checked for machine oil before drive by supporting it with the

Main stand on a flat ground. The oil level should be between the upper and lower

Lines of the oil gauge. Which is not screwed into the filling orifice.

★High quality 4-stroke machine oil. Class SE or SD in API classification. of SAE15W-40 in viscosity will help maintain a long service life of the engine. In case those are not available, a substitute suitable for the ambient temperature of application should be selected according to the table on the right side.

Lubricating oil	petrol engine	20W 50							
		5W 40 15W 50							
		10W 40 10W 50							
		10W 30							
		-30	-20	-10	0	10	20	30	40
		22	-4	14	32	50	68	88	104



Machine oil gauge

## Renewal of Machine Oil

Machine oil plays a very important role in the normal operation of the engine and for this reason, it is necessary to check the motorcycle for machine oil periodically and renew the oil once every 800-1,000km of driving by the following procedures.

Remove the screw plug from the bottom of the hot engine to drain off all old oil.

Wash the oil filter screen clean and remount it really to position. Then fill in 0.8L fresh machine oil and start the engine for idle running 2-3 minutes.

Let the engine stop for 1-2 minutes and check to see whether the oil level is in between the upper and lower lines of the oil gauge.

Do not use any machine oil of a different grade than the specified one to avoid machinery failure.

## Cleaning of machine oil tank

1. Drain off all the run –in machine oil from the oil tank.
2. Dismount the related parts.
3. Wash clean all the related parts.
4. Fill in the required oil.

\* This job should not be done by untrained persons but shall be done at an authorized service center.



## Check-up of Spark Plug.

1. Remove the cap of spark plug and screw off the spark plug by the plug wrench.
2. Clean the spark plug all around or replace it if it is corroded or there is too much deposit on it.
3. Regulate the gap of the spark plug to 0.6-0.7mm.
4. The spark plug of the designated type should be used. The applicable type of spark plug: NHSP LD D8TC made in China.



## Check-up & Cleaning of Air Filter

Take out the air filter and check if it is contaminated.

Dismounting:

Remove the right side cover,take out the screw and disassemble the air filter.

Cleaning:

Wash the filter in clean washing oil and wipe it dry with dry cloth.

Soak it in clean machine oil,squeeze it dry and fit it back to position.

Recommended oil:15W/40QE

Caution:

The air filter element for use must be intact or

the engine will suck in dust and dirt, resulting in a shorter service life of the engine.

Water should be prevented from entering into the filter in washing the vehicle.

The filter shall never be cleaned with gasoline or any other agent of a low ignition point.

## Adjustment of Throttle Cable

Make sure that the adjusting nut of the throttle cable and locking nut work normally.

Check to see if the throttle twist grip is with the required free operating movement.

The required free operating movement:2-6mm.

If the grip can not be so moved freely,turn the adjusting nut to ensure it.

After adjustment, start the engine and check for the free operating movement again,Repeat the adjustment if necessary until it is as required.

## Adjustment of Carburetor

Caution:

The adjusting procedures of idling speed:

- 1.Support the vehicle by a stand.
- 2.Adjust the idling speed by the throttle stop screw(1) to  $1500 \pm 150$ rpm.

**Caution:**

Do not try to cover up any trouble of other parts of the carburetor by adjusting the idling speed. In case of any abnormality with the carburetor,it has to

removed by your dealer.

Adjustment of idling speed shall be made only when the cold engine is warmed up or 10 minutes after the motorcycle is stopped from driving.

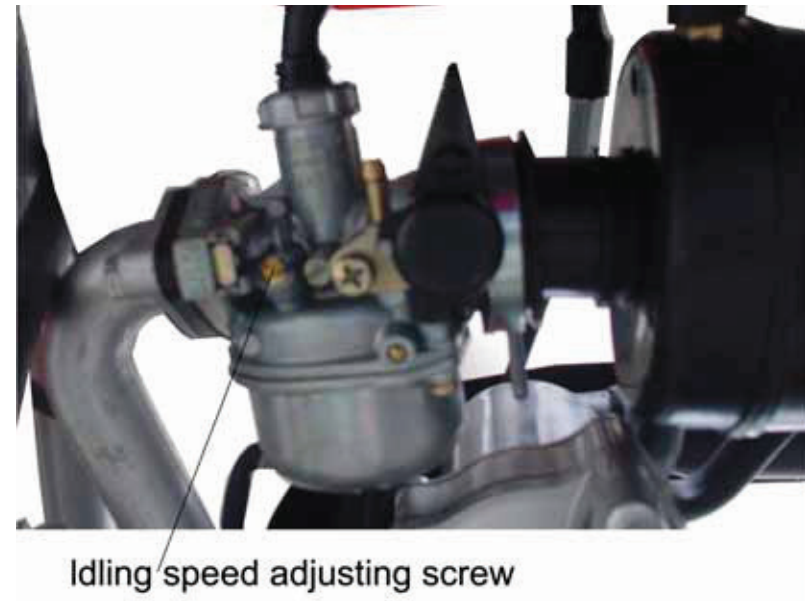

## Check-up & Adjustment of Air Valve Gap

Noise will stem from too big gap of the air valve. However if there is too small gap or even no gap at all, closing of the valve will be hindered, which will cause burn of the valve and output drop. Therefore, the air valve gap must be checked periodically.

The gap of the air valve should be inspected and adjusted with a cold engine by the following procedures:

1. Remove the caps of the central hole and the top hole (the ignition timing observation hole) in the left crankcase cover.

2. Remove the caps of the two air valves on the cylinder head.

3. Insert the “T” key into the central hole of the crankcase cover, jam it against the nut of the flying wheel and then turn the flying wheel clockwise until the engraved “T” mark on the flying wheel aligns with the engraved line on the top of the crankcase cover. Swing the rocking arm slightly. A loose rocking arm (which indicates the existence of clearance) shows that the piston is in the upper stop position of the compressing stroke, where the valve can be adjusted. A tight rocking arm means that the piston is in the lower stop position of the compressing stroke. In this case, continuously turn the “T” key clockwise for 360 degrees until the alignment of those engraved marks, where the valve can be adjusted. Afterwards, check the valve gap by inserting a feeler in between the valve adjusting screw and the end of the valve.

The specified air valve gap :0.05mm for the intake and exhaust valves respectively.

## Brake Checking

(1) pull up the front and rear brakes respectively and check for wear of the brake shoes. If the mark “△” on the brake drum cover aligns with that “△” on the brake cam, it means that the brake shoes are already worn to the limit and have to be replaced.

(2) Replacement should be carried out at a designated service center and it is recommended that the parts made by our company are used therein.

## Adjustment of Front Brake

(1) The front brake has a free operating movement of 10-20mm as shown in the figure on the right side.

(2) inspect the reservoir capacity and refill if necessary in order to maintain proper level in the reservoir. This should be the major project of your regular inspection

(3) check the front brake lining for its worn depth. if its worn depth is up to the limited mark, replace the brake lining. if the lining doesn't have limited mark but a concave slot as the figure, replace the lining while its worn depth up to the bottom of concave slot. replacement of a pair of linings shall be conducted simultaneously despite only one of them is worn.





## Adjustment of Rear Brake

★The vehicle should be supported by the main stand for check.

(1) The rear brake pedal has a free operating movement of 20-30mm as shown in the figure on the right side.

(2) To make adjustment, turn the rear brake adjusting nut clockwise to reduce and counter clockwise to increase the free operating movement of the brake pedal.

### Adjustment of Chain

1. When regulation is needed. Loosen the rear axle nut

2. Turn the chain adjusting nuts

on the left and right sides to adjust the tension of the chain and to align the marking of the chain adjuster with the engraved lines in the similar position, on both sides.

3. Tighten the lock nut and rear axle nut by a torque of 35-50Nm.

4. Repetitively check the tension of the chain.

5. When the rear wheel is changed in position and the chain adjusted, the free operating movement of the rear brake pedal will be affected, which, therefore, should be checked thereafter and also regulated if necessary

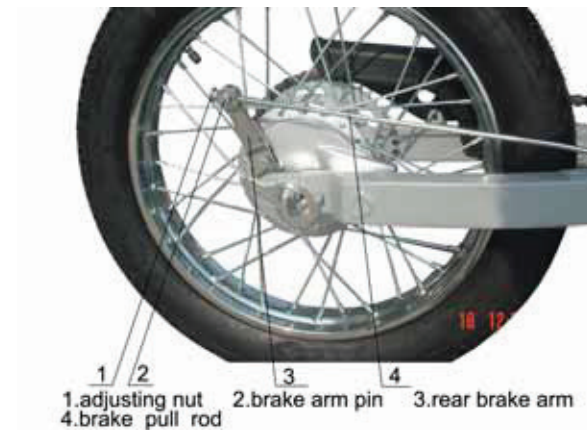

## [Greasing procedures to the driving chain]

1. Shut off the engine.
2. Add some machine oil or chain grease to the driving chain.

Attention:

When the rear wheel axil has moved to the back adjusting limit, if excess loose be cause of wearing to the driving chain, please change with a new one.

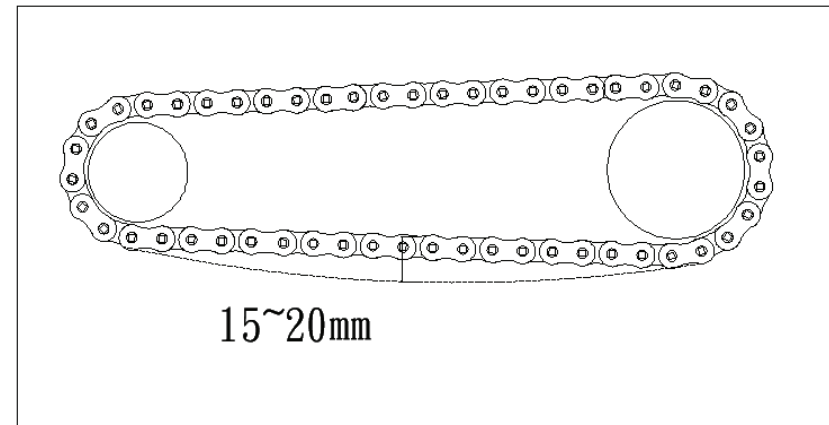

# Vehicle Washing

Cleaning the vehicle regularly can slow down the color fading of its body and make it easier to check if there is any damage and oil leakage with it.

Caution:

Washing the motorcycle with over-pressurized water may cause damage to some of its components. Therefore, do not jet over-pressurized water directly on to the following parts:

- Wheel hub
- Exhaust pipe
- Fuel tank and lower portion of cushion
- Carburetor
- Head lock and ignition switch
- Meters

(1) After pre-wiping, the vehicle should be washed with clean water to remove dirty residues so as to prevent corrosion. Plastic subassemblies should be cleaned by wiping with cloth or foam soaked in neutral detergent solution, followed by washing with clean water.

(2) After the cleaned vehicle is air dried, grease the chain and run the engine at idling speed for a few minutes.

(3) Prior to driving, carefully check the braking system repeatedly and repair or adjust it if necessary.

## Instructions for Storage

For the motorcycle not to be used for a long period of time, for example, in wintertime, some steps should be taken to prevent malfunction of and damage to its components which might be caused by long storage. Besides, before the long storage, proper maintenance has to be carried out for fear that it might be forgotten when the vehicle is put back into use after storage.

1. Change engine oil and oil filter.
2. Drain off fuel from the fuel tank and carburetor, spray atomized anti-rust oil onto the inside wall of the tank and then close the tank.

### **Attention:**

If the storage will last for more than one month, fuel in the carburetor must be fully drained off, which is very important because it will help ensure that the carburetor maintains its normal performance after the storage.

### **Warning:**

Gasoline is inflammable and may cause fire and even explosion under certain conditions. Therefore, do not smoke, make fire or have any fire left behind on

draining off fuel.

3. Take out the spark plug, pour about 15-20ml of clean engine oil into the cylinder, step down the kick lever repeatedly for several times, step down the kick lever repeatedly for several times so as to have machine oil distributed all over the engine and finally fit the spark plug back on.

### **Attention:**

The ignition switch must be set to “O”(off) position before stepping down the kick lever. To protect the ignition system from damage, the spark plug should be inserted in its cap and earthed.

4. Wash the vehicle clean, wipe it dry and apply an even coat of wax to the painted surface and a coat of anti-rust oil to the chrome-plated surface.

5. Inflate the tyre as required and pad the vehicle up by wooden blocks with the two wheels clear of the ground.

6. Put the vehicle in a shady and cool place free from humidity and direct sunshine and cover it properly (but not with plastic or other painted materials). If there is a garage, store it therein.

## Resumption of Service after storage

1. Remove the covering and clean the vehicle. Change the lubricating oil if the vehicle has been off service for over 4 months.

2. Drain off the remaining atomized antirust oil from the fuel tank, followed by filling it with fresh gasoline therein.

3. Prior to driving, all the required check-ups must be made. It is better to drive it at a low speed in a place of traffic safety to test its performance before normal drive.

### Table of Torque for Fasteners

Ser. No.	Fastener	Torque (N.m)
1	Front wheel axle nut	35-45
2	Rear wheel axle nut	50-60
3	Nut for tightening upper joining plate of front fork with vertical tube	40-50
4	Nut for fixing engine	20-25
5	Rear arm nut	35-50
6	Exhaust silencer nut	20-25
7	Bolt for tightening upper joining plate of front fork with shock	15-20
8	Bolt for fixing footrest	20-25

## Resumption of Service

1. Remove the covering and clean the vehicle. Change the lubricating oil if the vehicle has been off service for over 4 months.
2. Charge the battery and remount it.
3. Drain off the antirust solution from the fuel tank, followed by filling fuel therein to the required level.
4. Prior to driving, test the vehicle at low speed in a safe place.

### Maintenance Routine Diagram

The vehicle should be under good maintenance as specified in the following table, where:

“I” means: Check, cleaning, adjustment, lubrication and /or replacement are needed.

“C” means: Cleaning is needed.

“R” means: Replacement is needed.

“A” means: Adjustment is needed.

“L” means: Lubrication is needed.

“ \* ” means: This item of maintenance should be carried out at a service centre. It may be also done by the user himself with reference to this manual provided he has special tools, spare parts and is capable of this job.

“ \* \* ” means: This item can only be carried out by the serviceman at professional service center in order to ensure safety.

Notes: 1. Maintenance should be conducted more frequently when the motorcyclist drives in dusty areas.

2. When the read-out of the odometer exceeds the maximum figures specified in the table, maintenance should be still cycled according to the interval of mileage stated herein.

## Table of Maintenance



Frequency Items of Maintenance		Item /frequency	Odometer km (Note2)				
			1000km	4000km	8000km	12000km	remak
*	Circuit of fuel system			I	I		
*	Fuel filter		C	C	C	C	
*	Throttle operating system				I		
*	Choke of carburetor		I		I		
	Air filter element		Note1		C	C	C
	Spark plug				I		
*	Air valve gap				I		
	Air valve gap				I		
	Engine lubricating oil	R -yearly	One replacement every 300km, 600km, 1000km, 2000km.				
	Lubricating oil screen	R -yearly				C	
*	Tension of chain		A	A	A	A	
*	Idle speed of carburetor		I	I	I	I	
	Driving chain		I.L	I.L	I.L	I.L	
	Baliery	Monthly	I		I	I	
	Wear of brake shoes		I	I	I	I	Also for disc style
	Rear braking systems		I	I	I	I	
**	Brake liquid hose	R -4year	I	I	I	I	
**	Cup of braking liquid		I	I	I	I	
**	Braking liquid	R -2year	One replacement every two year				
**	Front braking system		I	I	I	I	
*	Rear braking light switch		I	I	I	I	
*	Light changing of front illuminator	I	I	I	I	I	
	Clutch		I	I	I	I	
*	Side stand		I		I	I	
*	Suspension		I		I	I	
**	Nuts ,bolts & other fasteners		I		I	I	
**	Bearing of steering handle		I			I	

