

# RAZKULL 125



# OWNER'S MANUAL

# Preface

Thank you for purchasing the SSR Motorsports Razkull 125.

Some features for this model include: large power, high speed, low fuel consumption, low noise, advanced structural design, and an attractive appearance. This owner's manual will introduce the general operation and maintenance procedures, please read it carefully for correct operation, maintenance / repair, and thus minimize the likelihood of failure of your motorcycle and maintain optimum performance.

Any SSR Motorsports dealer can provide you and your new motorcycle with any needed service you may require. You can find your closest dealer by following this internet link: [http://www.ssrmotorsports.com/store/dealer\\_locator.php](http://www.ssrmotorsports.com/store/dealer_locator.php) . The content of this owner's manual covers all existing configurations of this model.

The information, images, and specifications in the manual are based on the most recent product data information available at the time of publication. Since changes may have occurred or improvements, there may be differences between vehicles and this manual. SSR Motorsports reserves the right to make changes any time, without having to make notification.

# TABLE OF CONTENTS

Safe-driving of the motorcycle.....	3	Check and Adjustment of the Front Brake System.....	27
The protective device.....	4	Removing the Rear Wheel.....	27
Notice of Parts Replacement.....	4	Brake Fluid.....	28
Load and Accessories.....	4	Battery Maintenance.....	30
Tires.....	6	Fuse Location and Replacement.....	31
VIN and Engine Number Locations.....	7	Adjustment of the Rear Brake Light Switch.....	32
Component Names and Locations.....	8	Cleaning your Motorcycle.....	32
Meters and Indicators.....	11	Periodic Maintenance Table.....	33
Fuel and Lubricant.....	14	Storage of your Motorcycle.....	35
Operation Guidelines.....	16	Main Technical Data.....	36
Starting the Engine.....	17	Electrical Diagram.....	37
Engine Break-in.....	18	Emissions Control Device.....	38
Operation of the Motorcycle.....	19		
Brake Operation.....	20		
Maintenance and Service.....	21		
Selection and Replacement of the Spark Plug.....	22		
Cleaning and Assembly of the Air Filter.....	23		
Valve Clearance Adjustment.....	24		
Adjustment of the Carburetor.....	25		
Check and Adjustment of the Drive Chain.....	26		

# Safe Operation of your Motorcycle

## Operation:

Be sure to use the utmost caution when riding a motorcycle. Do not drive until all of the safety requirements outlined here are fully understood

### Safety Driving Operations:

1. Check the motorcycle before every ride to avoid accidents from damaged or worn out parts.
2. An operator with little riding experience may cause an accident. According to national laws, a driver must have passed the DMV motorcycle test and have been granted a motorcycle drivers license to be allowed to drive the motorcycle. It is not permitted to lend your motorcycle to anyone without a license.
3. The collision between a vehicle and a motorcycle is always caused by the vehicle driver not seeing the motorcycle. Bright colored riding gear and reflective tape can increase your visibility to be seen by other drivers and to avoid accidents.

Dress in bright and reflective clothing (such as yellow and red, etc.)

Do not ride close to other vehicles or ride in the blind spot of another vehicle's view.

4. Observe the local and national laws and regulations: Driving the motorcycle over the speed limit can lead to an accident. Observe the speed limit signs and do not drive the motorcycle exceeding the top speed regulation.

When making a turn or changing lanes be sure to turn on the turn signal light and check your mirrors.

5. Special care should be taken when driving near cross walks and the entrances of parking lots.
6. When riding, hold the handle bar naturally and loosely within your hands, step on the footrests firmly with your feet. Your passenger should hold onto the driver or hold the armrest with hands and step on the footrests with their feet.

## **Protective Gear**

1. Always wear a helmet, riding pants, a riding jacket, glasses and gloves when riding to ensure your safety.
2. The exhaust system will be very hot while riding, the rider should wear clothing which covers the leg and wear riding boots to avoid being burned.
3. Avoid oversized clothing as it can present a hazard if it gets caught on the levers, footrests or handlebars, this will help you avoid an accident.

## **Aftermarket Parts Use**

Warning:

If the motorcycle is refitted and the original parts are removed, it may not conform to traffic regulations or endanger safe riding. The national and local traffic regulations should be observed.

## **Load and attachment**

Warning:

To avoid accidents, special care shall be taken when picking up luggage and adding accessories to the motorcycle. The adding of accessories and luggage will be detrimental to the good performance and stability of the motorcycle and can effect the safe operation.

## Load

1. Keep the center of gravity of cargo at a low position near the center of motorcycle. Loads carried on the motorcycle should be distributed onto the two sides equally to reduce unbalancing of the motorcycle. If the center of gravity of the load is far away from the center of gravity of the motorcycle, the riding balance will be affected.
2. Conduct proper adjustment of the tire pressures (refer to the tire chapter) and rear shock absorber spring adjustment according to the carried load and driving conditions.
3. The load and accessories must be firmly fixed to ensure the balance of the motorcycle and the stability of the load should always be checked.
4. Do not over-load your motorcycle with heavy cargo on the handlebars, or front fork and fender, otherwise it may unbalance your motorcycle which could result in slow steering operation.

## Accessories

The original accessories of our motorcycle are specially designed and tested in our motorcycle. We cannot test every possible combination of after-market products from any other factories. You will held responsible for the proper selection, installation and usage of accessories produced by other factories and installed on your motorcycle. Observe the above mentioned "load" requirement and don't over load.

## When Installing Accessories:

1. Carefully check any accessories. Does it obstruct your view, reduce the ground clearance and the tilling angle, limit the moving of suspension and steering mechanism or hinder the controlling operation?
2. Do not install any accessories such as a windshield which could effect riding operation by increasing the wind resistance which could cause unsteady driving. Do not install any drag reducing devices which would effect the airflow cooling the engine.
3. Do not install any electrical equipment which may overload the power consumption of the motorcycle, blow fuses and even cause dangers such as blowing of the lighting fuse of the motorcycle lamps and signal indication lamps.
4. The design of this motorcycle is not suitable for hanging a sidecar or trailer. If a side car or trailer is installed, the motorcycle could be heavily damaged.

The recommendations made above should help you in knowing how to equip your motorcycle and load it safely.

## Tires

The proper tire pressures help keep the best stable and comfortable riding and increase the life span of the tire.

Items	Data	
Tire Size	Front: 120/70-12	Rear: 120/70-12
Tire Pressures	Front: 33 psi $\pm$ 1.5	Rear: 33 psi $\pm$ 1.5

If you find any damage, please contact your local dealer or repair station.

### Warning:

- Improper tire pressures may cause abnormal tire thread wear and can cause an accident. Insufficient tire pressure may cause slippage of the tire or unbeading of the tire to the rim.
- Riding on excessively worn tires is very dangerous.
- The minimum depth limits of the tire thread may be inspected by looking for the TWI or (Tread Wear Indicator) replace the tire immediately when the tire thread in the center of tire is worn down to the TWI or reaches the below limits:

Warning:

Front Tire: 1.60mm

Rear Tire: 1.60mm

Conduct proper balancing of wheels after performing a tire replacement to ensure the steady and safety driving.

## VIN

The motorcycle's VIN number is punched into the right side of the steering stem of the motorcycle frame.



## PRODUCTION LABEL

The production label is riveted on the left of the frame.



## ENGINE NUMBER

The engine number is punched into the right side of the engine crankcase cover.





## Device and Operation Description

- 1.) Rear View Mirror
- 2.) Left Handlebar Switch
- 3.) Speedometer
- 4.) Front Brake Lever
- 5.) Ignition Switch Assy.
- 6.) Throttle
- 7.) Right Handlebar Switch

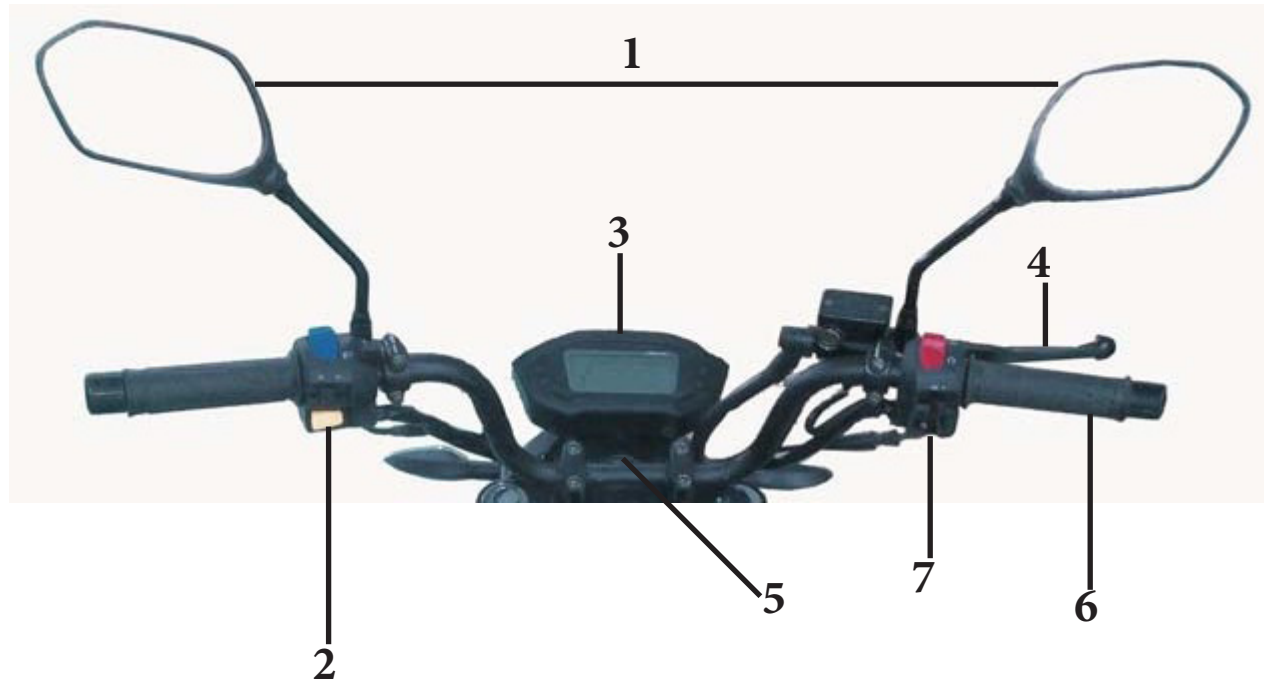



- 1.) VIN Number
- 2.) Engine Number
- 3.) Gear Shift Pedal

- 4.) Front Left Footrest
- 5.) Main Support
- 6.) Rear Left Footrest



- 1.) Rear Right Footrest
- 2.) Front Right Footrest
- 3.) Rear Brake Pedal

## Meter and Indicator Lights

The meter is located in between the handlebars in front of the handlebar clamp.

- 1.) Left Turn Signal Indicator Light: this light is on when the left turn signal light is turned on.
- 2.) Headlight High Beam Indicator: when the high beam is on this lamp will light.
- 3.) Fuel Level Indicator: "F" indicates full, "E" indicates empty, the gauge will turn red when it reaches "E."
- 4.) RPM Meter: Indicates the engine crankshaft rotation speed.
- 5.) Speedometer: Indicates the driving speed of the motorcycle.
- 6.) Odometer: Records the total accumulated mileage of the motorcycle; pressing "TRIP" will indicate the resetable driving mileage total; long press: will return the total trip mileage to 0.
- 7.) Right Turn Signal Indicator Light: this light is on when the right turn signal light is turned on.
- 8.) Clock Adjustment Button: press this button to adjust local time on the meter.
- 9.) Clock: displays the local time.
- 10.) Gear Position Indicator: displays the current transmission gear.
- 11.) Mileage Reset/ Adjustment Button: when "TOTAL" is displayed, long pressing the button changes between miles or kilometers.
- 12.) Neutral Position Indicator: this lamp is on when the transmission is in the Neutral position.

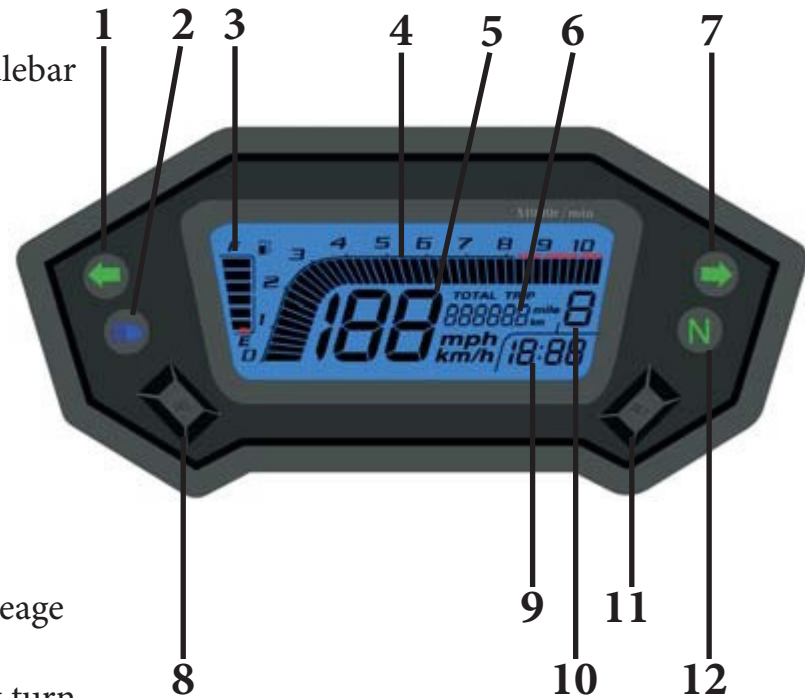

## Ignition Switch

The ignition switch (1) is located at the middle bottom of the gauge cluster.

**OFF:** All circuits are off, the speedometer cluster is off. The engine cannot be started. The key can be removed.

**ON:** All the circuits are on, the speedometer cluster is on. The engine can be started. The key cannot be removed.

## Steering Head Lock

Turn the handlebars to the left until they stop, then turn the key to the OFF position, push the ignition switch downward and turn it counter clockwise to the LOCK position, then pull the key out. To unlock, just turn it clockwise.

**CAUTION:** When parking or leaving the motorcycle for a long time, switch to the OFF or LOCK position to ensure the safety of the motorcycle and prevent the battery from discharging.

## Fuel Gauge

The fuel gauge indicates the instantaneous quantity of fuel in the fuel tank, which has a capacity of 2.9 gallons. When the fuel gauge reads empty and changes to a RED INDICATOR, please refuel immediately.



## REDLINE OF THE RPM METER

### NOTES:

Do not allow the engine RPM to stay in the redline area of the meter (1), even if the engine has been broken in.

It is easy to rev the engine to the redline if the engine is revved while in neutral, take care not to do so. The redline zone indicates the maximum rotational speed of the engine. If the engine is allowed to run in the redline for prolonged periods of time the total service life of the motorcycle could be affected.



(2) Turn Signal Switch (3) Horn Button (4) Headlight High/Low Switch (4) Passing Switch

The turn signal switch has three positions. Turn the switch to “←” position for left turn signal, and the front and rear left turn signal lights will turn on; Turn the switch to “→” position for right turn signal, and the right front and rear turn signal lights will turn on. When the turn or lane change has been completed, press the switch in the middle position to turn off the light.

Headlight High/Low Beam Switch

Turn the headlight high/low beam switch to the upper position for high beam; turn the switch to the lower position for low beam.

Horn Button

Press down the horn button and the horn will sound.

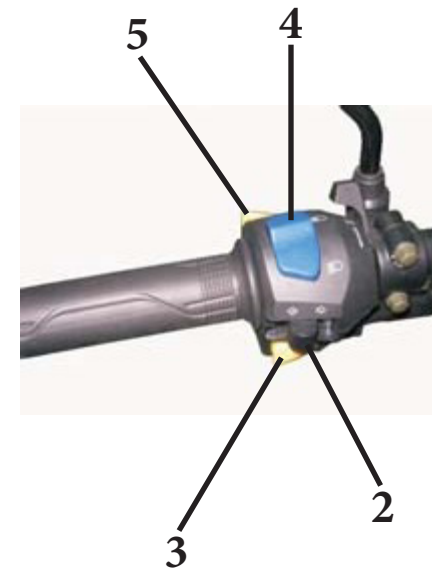

## Fuel Tank and Fuel

The capacity of the fuel tank is 2.9 gallons.

Use only unleaded gasoline whose octane rating is 91 or above.

To open the fuel tank cap:

1. Fuel Tank Cap (1),
2. Insert the ignition switch key into the fuel tank cap (2),
3. Turn the key clockwise 90°,
4. Open the cap and fill the fuel tank, when filled with fuel close the cap and press along the top edge until you hear an audible “click.”

### Notes:

- Use only unleaded gasoline whose octane rating is 91 or above.
  - Do not overfill the fuel tank (don't fill the tank with fuel past the filler neck).
- For your safety, always close the fuel tank cap and lock the seat after fueling.
- Gasoline is flammable and may cause explosions under certain conditions, first check if the engine is completely stopped when opening the fuel tank cap. Always fuel your motorcycle in a well ventilated area free of open flames or sparks.

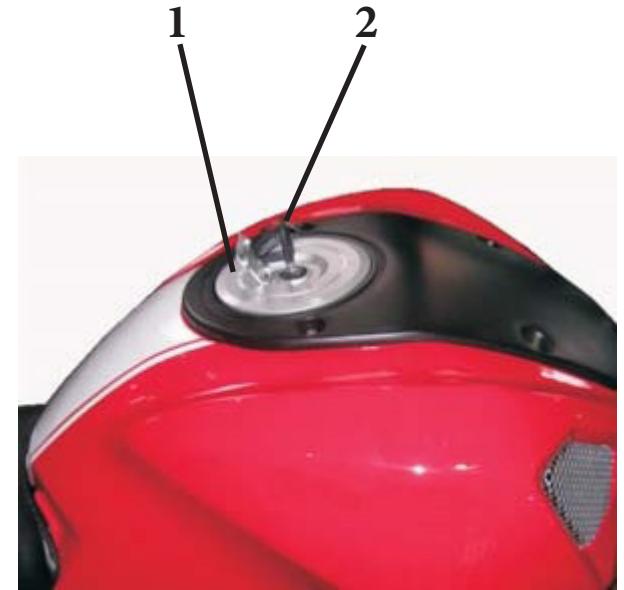

## Fuel Petcock

The fuel petcock (1) is located under the left side of the fuel tank cover, just below the fuel filter that is attached to the carburetor. The petcock has three positions: turn the petcock switch handle to the “•” position, the fuel will be shut off. When you do not use your motorcycle, set the lever to this position.

When you need to use the motorcycle, turn the lever to the lower position“



1



## Engine Oil

The engine lubrication oil is an important factor effecting the performance and service life of the engine. Select as per the specified requirement while replacing. Normal engine oil, gear oil, plant oil isn't allowed to be used.

The engine should be filled with SG Grade 15W/40 engine oil.

If you are replacing the oil with another lubrication oil, the quality degree should be QE, and the viscosity should be selected according to temperature of the varying areas of operation (refer to the attached table).

When replacing the lubrication oil, drain all the existing lubrication oil in the crankcase. Then refill with new lubrication oil as per the specified requirement.

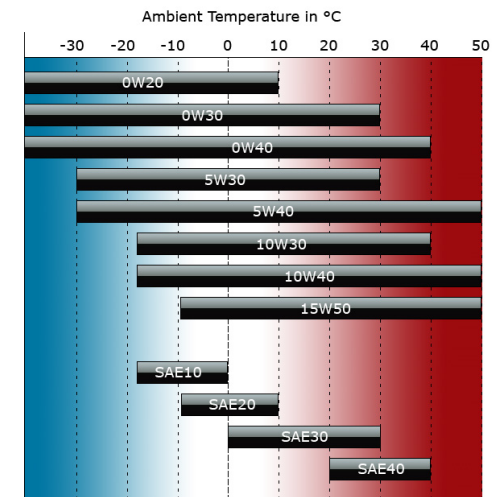



## Operation Guide

Check prior to operation:

Conduct an overall check before using the motorcycle, especially the following items:

Check the lubrication oil level - add lubrication oil if necessary and check if any oil leakage has occurred.

Check the fuel level - fill the fuel tank if necessary and check if any fuel leakage is occurred.

Check the front and rear brakes - check the function of the front and rear brakes. Adjust if the free travel is too long or short.

Check the tires - check the tire pressures for the front and rear tires, also inspect for wear or damage to the tires.

Check throttle grip operation - check the operation of the throttle grip, make sure the free play is not excessive and adjust it if necessary.

Check the battery condition - check the batteries charge level, recharge the battery if below 12.2 Volts.

Check the lighting and signals - check the function of the headlight, tail light, turn signal lights and horn are all good.

Check the drive chain - check the tension of the chain and lubrication condition and adjust if needed. Replace it if serious wear or damage has occurred.

Check the steering mechanism - check the flexibility and stability of operation. Check the front and rear wheel axle nut, front fork, for stability.

Note:

Check the fuel circuit and fuel lines. Tighten any hose clamps and replace and hoses that appear to be cracked or damaged.

The electric parts between the ignition coil and spark plug should be firmly connected to avoid accidental electrocutions.

## Starting the Engine (1)

1. Turn the fuel petcock to the “ON” position.
2. Insert the key into the ignition switch and turn it to the “ON” position.
3. Make sure the transmission is in the neutral position, neutral indication lamp is on, or if the transmission is located in any gear, pull in the clutch lever.
4. Turn on the choke lever (1), pull it toward you (don't use the choke if the engine is warm).

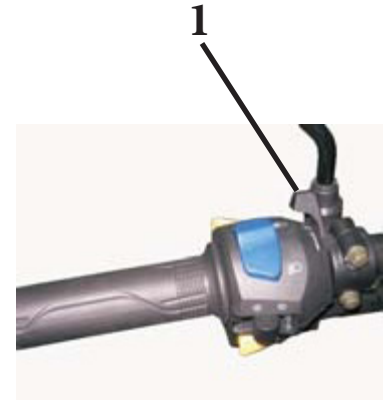

## Electric Starter

Press down the start button, and release once you hear the engine begin to run. Return the choke to the closed position after starting.

Caution:

- Do not press the electric start button for longer than 3 seconds at a time, otherwise you can over-discharge of the battery.
- If the engine cannot be started by the starter three times in a row, then diagnosis will be necessary to correct the starting problem or use the kickstarter lever instead.
- Immediately release the starter button after the engine has successfully started.
- DO NOT press the starter button once the engine has started and is running.
- DO NOT start the engine with the electric starter when the voltage of the battery is too low. Instead use the backup kickstarter.

Caution: The exhaust produces carbon monoxide gas when running. Do not start the engine in a closed garage or unventilated space.

## **Engine Break-In Procedures**

In order to make sure your new motorcycle will run for years to come you must break-in the engine.

The break-in mileage of a newly purchased motorcycle is 600 miles. The primary 600 mile break-in is very important for the performance and service life of the engine.

Avoid completely opening the throttle during the break-in period and selection of gears must be chosen in order to the engine RPM below 6,500. (see the speedometer)

### 1.) 0 miles to 100 miles

While riding, DO NOT open the throttle more than 1/4 turn. After running the engine for 30 minutes to 1 hour, stop the engine for 10 minutes to allow it to cool. Vary your speed and gear frequently. Don't ride the motorcycle in a fixed throttle position or gear.

### 2.) 100 miles to 300 miles

During riding, DO NOT open the throttle more than 1/2 turn. DO NOT completely open the throttle; change your speed and gear frequently and do not drive in a fixed throttle position or gear. Low gear running is forbidden.

### 3.) 300 to 600 miles

During driving, DO NOT open the throttle more than 3/4 turn, change your speed and gear frequently, fast-speeds and wide open throttle should be avoided.

Note: After running 600 miles, change the engine oil and clean the air filter. Check all other systems specified in the periodic maintenance table at the 600 mile interval. This will keep the motorcycle in good working order and will prolong the service life of the engine notably. If any trouble is found during run-in, please ask the agent or service station for repairing immediately.

## **Driving the Motorcycle:**

- 1.) Turn on the ignition switch, pull in the clutch lever firmly and start the motorcycle (if the engine is cold, use the choke lever)
- 2.) Accelerate the engine gradually and release the clutch lever slowly, match these two operations to ensure stable starting.
- 3.) Control your driving speed by using the throttle.
- 4.) After the motorcycle is driving steady, decelerate the engine speed, pull in the clutch lever firmly and step down on the shift pedal into 2nd gear. Shift into the other gears using the same method.
- 5.) When you need to stop the motorcycle, please release the accelerator and reduce your driving speed gradually with the brake pedal and brake lever.

## **Note:**

Only shift gears when the clutch is disengaged and the throttle is decreased otherwise the engine, drive chain and other parts could be damaged. Operate the front and rear brakes in unison, do not brake violently to lower the braking effectiveness, and the controls of the motorcycle would become difficult.

## Maintenance and Service

Check and change the engine oil, clean the oil-filter mesh screen

Check the engine oil level before driving every day.

The engine oil level gauge (1) is located on the rear of the right crankcase cover, which is used to measure the engine oil level. The level must be within the upper (2) and lower (3) oil level marks on the dipstick.

1.) Place the motorcycle on a rear stand (sitting vertically), remove the engine oil dipstick and clean it. Insert the engine oil dipstick into the crankcase and take out to check the result.

2.) Fill with engine oil until it reaches the upper dipstick mark. DO NOT overfill it.

3.) Reinstall the engine oil level dipstick, checking whether its leaking.

Note: When the engine is running, insufficient engine oil would damage the engine; it will increase oil consumption and cause the engine to overheat causing engine seizure.

Changing the engine oil, clean the oil-filter mesh screen, drain the engine oil when the engine is still warm.

1.) Remove the engine oil dipstick.

2.) Place an empty container under the engine, remove the oil drain bolt (4) which is under the engine, take out the oil-filter mesh and spring.

3.) Make sure the ignition is off and kick the kickstarter lever several times to help drain the oil.

4.) Clean the oil drain bolt, oil filter mesh and spring with contact cleaner.

5.) Reinstall the oil drain bolt, using a new crush gasket and making sure it is tight.

oil-filter mesh and spring with detergent. oil-filter mesh and spring and make sure

6.) Fill the engine with the recommended lubrication oil (1 liter), reinstall the engine oil dipstick, and start the engine. Allow it to run for several minutes then turn it off, wait another few minutes then remove the dipstick and check the engine oil level, add oil if necessary.

### Note:

If operating in a dusty area perform these services more often.

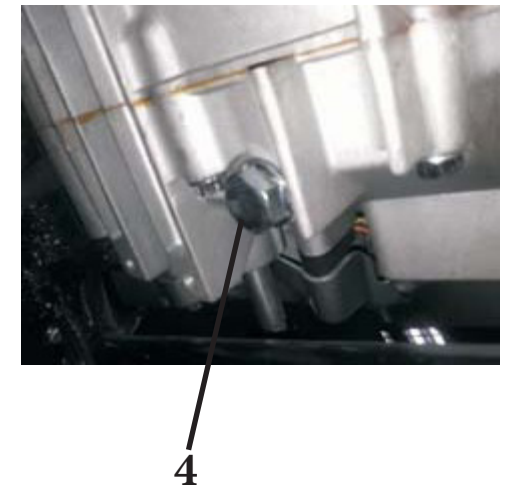

## Spark Plug and Replacement

Spark plug specification: CPR8EA-9

- 1.) Remove the spark plug cap, remove the spark plug with the wrench in the tool kit. Clean any carbon deposits and dirt from the spark plug with a steel wire brush.
- 2.) Check whether the electrode of spark plug is damaged or not and the side electrode is eroded.

Replace the spark plug if required.

- 3.) Check the spark plug electrode gap with a thickness gauge and adjust it to (0.6-0.7)mm. Check the gasket seal of the spark plug is ok or not.
- 4.) When installing the spark plug, in order to prevent cross threading, screw in the spark plug by hand and then tighten it with the wrench.

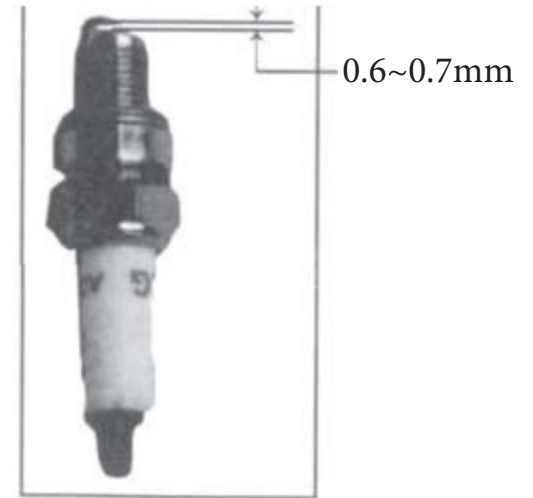

## Cleaning and Assembly of the Air Filter

Clean the air filter after driving the first 600 miles. You should clean your air filter more often if driving in a dusty area. The air filter is a foam filter core.

- 1.) Remove the bracket (1) and then remove the fuel tank decoration cover (2).
- 2.) In order to remove the air filter upper cover, please remove the 8 screws (3), then take out the air filter element.
- 3.) Clean the air filter element (4) with foam filter cleaner and allow it to dry out under the sun.
- 4.) Add air filter oil to the air filter element. Squeeze out the remaining oil.
- 5.) Assembly is in reverse order of disassembly.

### Warning:

- If the air-filter is covered by dust or overfilled engine oil, the fuel consumption will be largely increased, and the performance of motorcycle will be effected.
- Gasoline is flammable, DO NOT clean your air filter element with it.

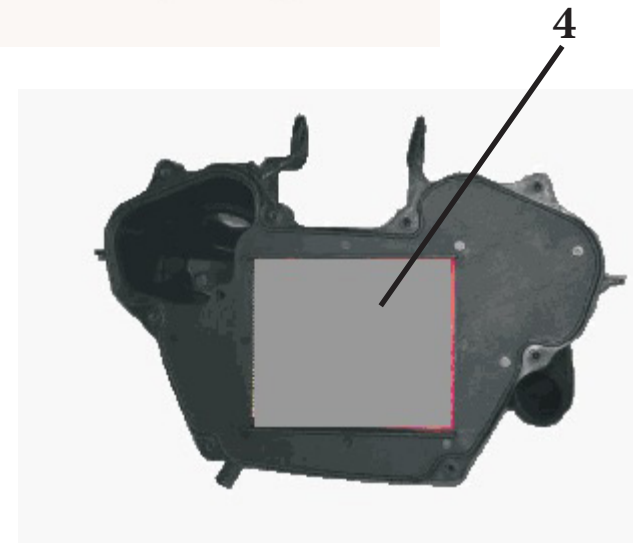

## Check and Adjustment of Valve Clearance

- 1.) Remove the ignition timing hole cover, the small cover in the left crankcase cover and the two valve tappet covers.
- 2.) Turn the rotor of the engine counterclockwise and align the “T” mark with the ignition timing hole cover in the same position. Touch the rocker arm with your finger to check if the piston is at the TDC point of compression stroke. If the rocker arm is firmly tightened, turn the rotor of engine counterclockwise by 360 degrees, and align with the “T” mark again.
- 3.) Insert a thickness gauge between the adjusting screw of the rocker arm and the top end of valve shaft, check the gap between the valve and the adjuster screw. The standard valve gap is: Intake 0.05mm, Exhaust 0.05mm.
- 4.) Loosen the locking nut (2) and rotate the screw (1) when you want to adjust. Check the valve gap again, after tightening the locking nut. Finally, install the ignition timing hole cover, and the center hole cover in the left crankcase cover.

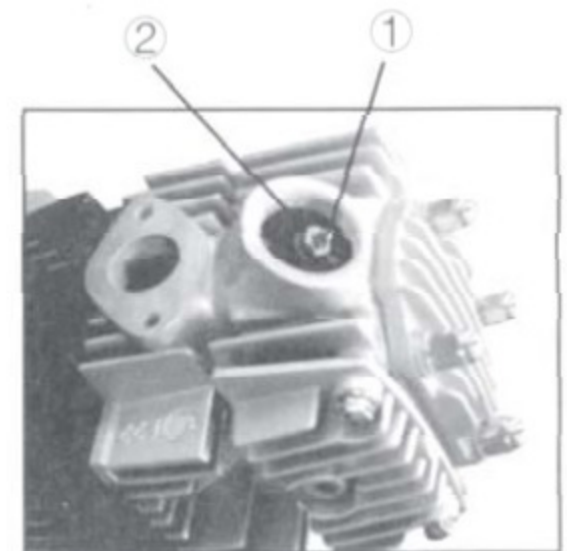



## Adjustment of the Throttle

- 1.) Check the throttle grip. Make sure that the throttle can be easily rotated from open to close without binding or catching.
- 2.) Check the throttle cable to carburetor, make sure it is routed properly and is not binding or sticking. Rearrange the cable as needed if routed the wrong way.
- 3.) Check the throttle free-play at the grip. The standard free-play travel is 2mm to 6mm.

Adjusting the Throttle:

Loosen the lock nut (1) and turn the adjuster (2).

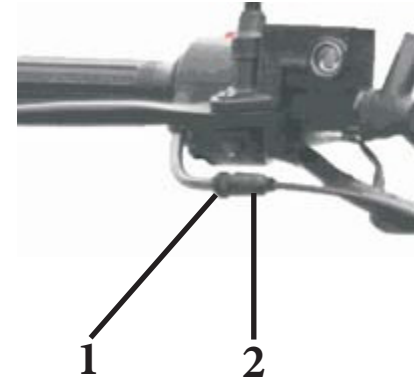

## Carburetor Adjustment

- 1.) Start the engine and warm it up, bring it to the normal operation temperature.
- 2.) Adjust the idle speed to  $(1500 \pm 50)$  r/min by adjusting the idle adjuster screw (3). Turn the idle screw clockwise to increase the idle speed and turn it counterclockwise to decrease the idle speed.
- 3.) Adjust the screw clockwise till the engine has no idle or decelerates, then adjust it counterclockwise until the engine is in the condition of showing no idle speed or decelerating again. Place the screw between the above mentioned two limit positions (the position of the two ends) to adjust fuel and air mixture. Make a mark before adjusting the air mixture screw, so that it will be convenient to return to the stock setting if/when you make mistake.
- 4.) If the idle speed is to be changed after preparing, readjust the idle speed screw to readjust the idle speed.

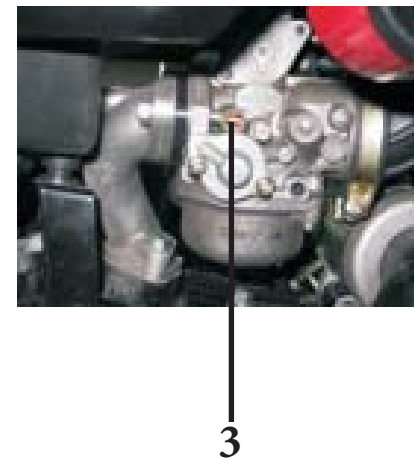

## Adjustment and Lubrication of the Drive Chain

Check the tension of the drive chain. Apply chain lubricant if the chain is dry.

- 1.) Using your finger move the chain up and down, a moving range of 10-20mm is allowed.
- 2.) Check the chain function by turning the rear wheel. Apply chain lubricant if it is not rotating freely until it no longer binds or is dry.
- 3.) Check the chain wear, if the chain or sprockets are found to have serious wear, it should be replaced as a full set immediately. DO NOT use a new chain and old sprockets together which are seriously worn, it will accelerate the wear of the chain. Loosen the rear wheel axle and adjust the chain when it is needed.

Make sure the chain adjuster on the left and right (1) are adjusted evenly (2). Adjust until the chain has the proper tension and then tighten the axle nut of the rear wheel axle. You must also adjust the rear brake when making a drive chain adjustment to allow of the best rear brake performance.

## Drive Chain Lubrication

Lubricate the drive chain with a motorcycle specific drive chain lubricant. If it is necessary to clean and then lubricate the drive chain then follow the steps below:

- 1.) Remove the countershaft sprocket cover, chain guard and remove the clip from the removable chain link. Remove the drive chain.
- 2.) Clean the chain using a motorcycle chain cleaner to remove all of the soil and dirt, then dry it.
- 3.) Reinstall the chain after you have lubricated the chain, and assemble the removable chain link again (making sure the clip is facing the direction of travel - see picture to the right).
- 4.) Adjust the chain's tension and rear brake, reinstall the countershaft sprocket cover and the chain guard.

**Note:** Ensure the chain link is installed in the correct position.

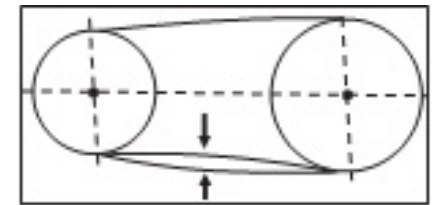
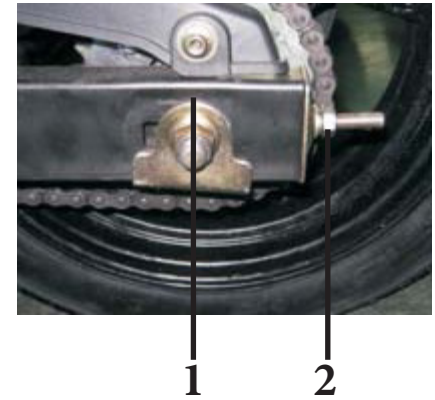

10~20 mm

Chain Tension Diagram

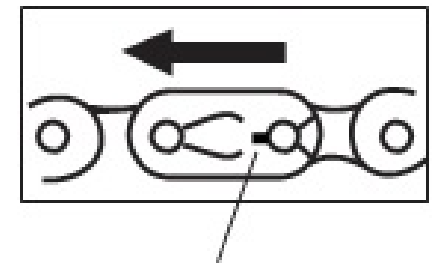

Drive Chain Link Clip

## Hydraulic Disc Brake Inspection

- 1.) The front brake lever should have a firm feeling when operated.
- 2.) Check the brake fluid level within the master cylinder (1) : keep the bike upright on a flat surface, turn the handlebars to the right, and check the level mark, the fluid level in the master cylinder should be at the upper mark on the window.
- 3.) Visually inspect the front and rear master cylinder for brake fluid leaks. (No cracks in brake lines (2) or leaks from the master cylinder cap).
- 4.) Check the brake rotor wear (3). When the thickness of the brake rotor reaches the minimum thickness, then the brake rotor should be replaced. The minimum thickness for both the front and rear brake rotors is 3mm.

### Notes:

- 1.) Hydraulic disc brakes operate under high pressure, to ensure the safe and reliable operation the suggested replacement time of brake fluid hoses, brake pistons and brake fluid should not exceed the time specified in the manual.
- 2.) This product uses a dual hydraulic front disc brake system. For additional maintenance or repair, and to ensure your safety brake system service should only be performed by an authorized dealer or repair station personnel.
- 3.) If the brake lever or handle feels spongy, there is air in the brake system. Any air trapped in the front or rear brake system must first be bled out of the system before the motorcycle can be operated. Otherwise the air will observably reduce the braking performance, and can also lead to failure and/or accidents. Adjustment and bleeding should be done by professional dealership personnel.
- 4.) When replacing the brake rotors, you should not ride immediately. The brake discs should be scrubbed into the new brake pads before the motorcycle is ridden normally. This can be done while the unit is on a service rack and while the unit is being test ridden by the mechanic who performed the repairs.

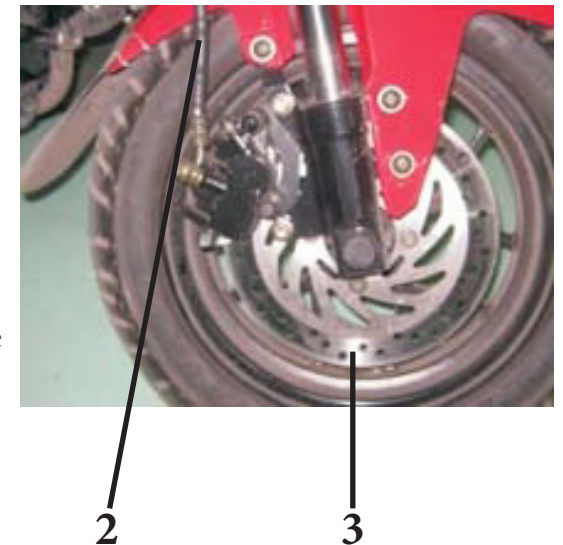
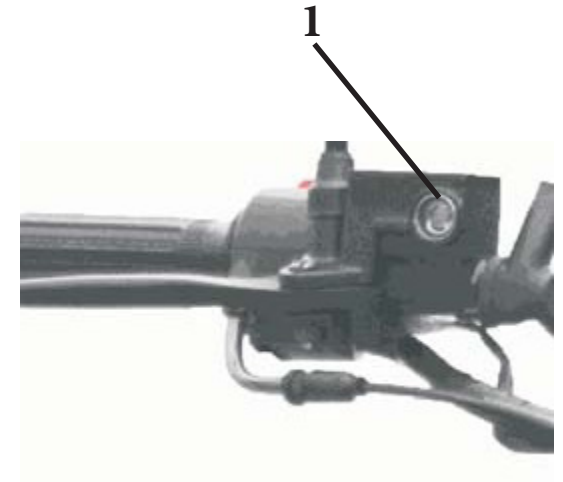

## Brake Fluid

1.) Front brake hydraulic brake oil grade is DOT 3/4. Do NOT use any other type of brake fluid, such as silicon or petroleum based brake fluid, otherwise it will damage the brake system seriously.

2.) Never use brake fluid from expired or open containers; also do not use brake oil left in the last maintenance or brake oil in long time storage, because these brake fluid has absorbed moisture the air contained.

3.) Brake fluid is a strong corrosive, do not let any brake fluid spilled on painted surfaces or plastic surfaces sit without cleanup, otherwise it will lead to paint or plastic discoloring or peeling.

If brake fluid gets on the skin, rinse immediately with plenty of water. If ingested please call your local poison control center for instructions.



REAR BRAKE PEDAL FREE PLAY  
20 ~ 30 mm

## Rear Tire Assembly & Disassembly

- 1.) Support the motorcycle via a rear swingarm stand or tied down to a motorcycle lift with the wheels off of the ground and balanced.
- 2.) Loosen the chain adjuster nuts (2) on both sides so that the chain can be lifted off of the rear sprocket and set gently on the swingarm end. Remove the rear axle nut (3).
- 3.) Push the rear wheel forward in the chain adjusters and lift the chain off of the rear sprocket.
- 4.) Slide out the rear axle (1) (make sure you hang onto the rear brake caliper carrier and swing it over the swingarm) then remove the rear wheel.

Reinstall the rear wheel using the reverse procedure of above. The rear axle nut torque: [60 ft. lb. or 80N.m]

Adjustment of the rear brake and drive chain is covered in the previous chapters. Pump the rear brake pedal several times after the rear wheel is reinstalled in order to build up brake pressure again. The rear wheel should rotate freely after releasing the brake.

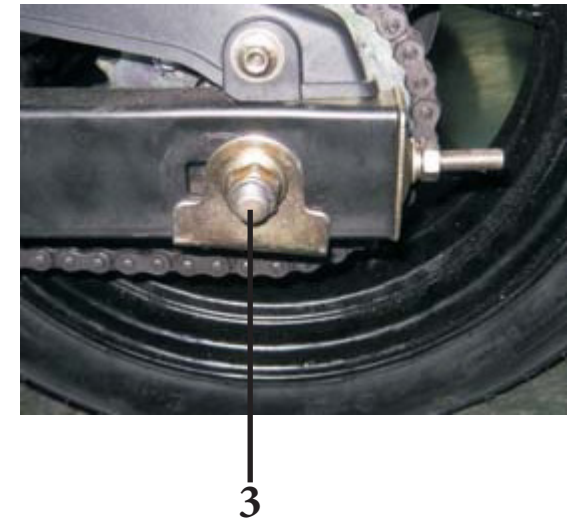
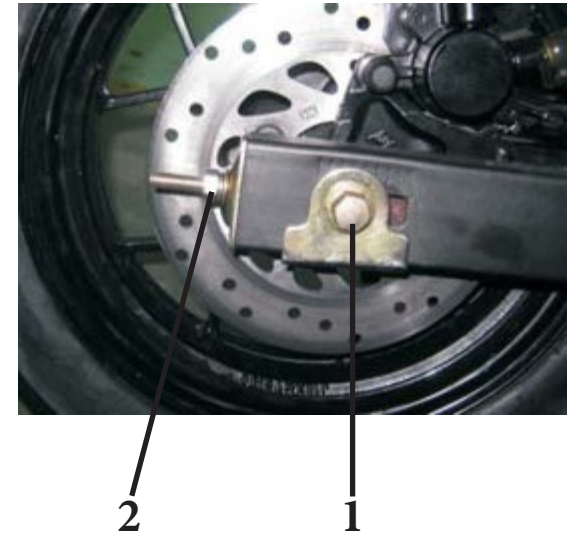

## Battery Maintenance

The battery is located under the seat.

This motorcycle uses a 12V4A.h. battery. Check the battery according to the periodic maintenance table and the driving distance listed on said table prior to driving. Please follow the safety instructions for batteries strictly when installing a new battery. It will be used for the starting and lighting of the motorcycle. The battery should not be used to operate the headlight or taillight when the engine is not running, this could cause discharge of the battery which could lead to a dead battery and no electric starts.

Only remove the battery when the motorcycle is not in use. First remove the negative terminal when removing the battery from the motorcycle. Store your battery in a well ventilated and sheltered area after charging. If storing your motorcycle, remove the negative terminal from the battery, and check it regularly. Please store the battery indoors at temperature of 68°F or higher.

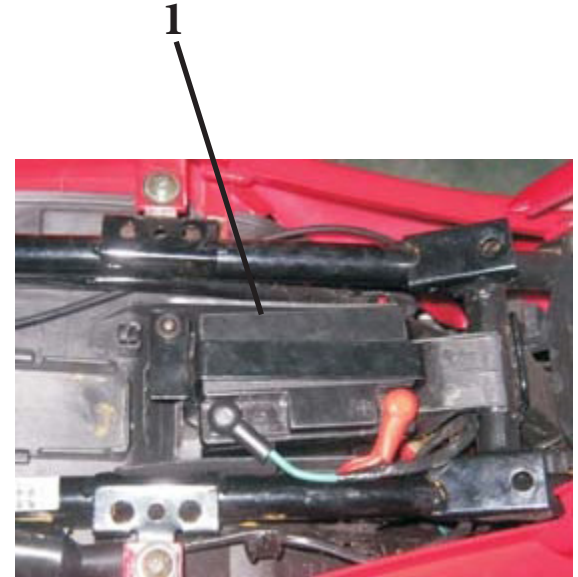

## Fuse Replacement

The fuse is located near the battery. The rated current of the fuse is 10A. If the fuse blows often, which indicates a short circuit, please take your motorcycle to an authorized SSR Dealership for repair. If the fuse blows, **DO NOT** use anything other than a fuse to replace a blown fuse. **DO NOT** simply attach the two ends of the fuse holder together, this could lead to serious damage or fire.

When replacing the fuse, make sure the ignition switch is in the off position, open the fuse outer cover, remove the blown fuse. Use pliers to ensure both ends of the fuse are securely connected to each end of the wire harness then close the fuse cover.

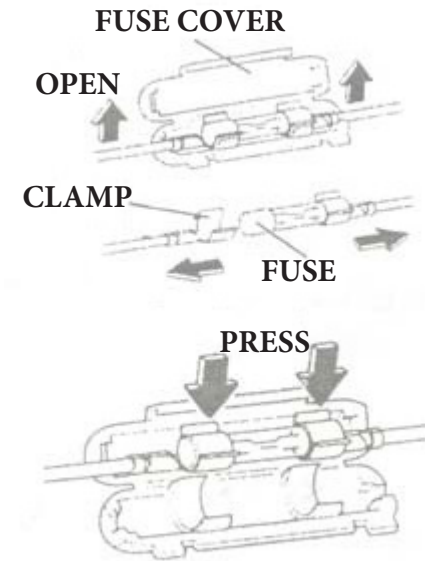

## Rear Brake Light Switch Adjustment

Adjusting method: If the rear brake lamp does not light up immediately, turn the adjustment nut (2) clockwise. If the brake lamp lights up too early, turn the adjustment nut (2) in a counter clockwise direction. The rear brake light switch (1) is located at the rear of engine on the right side at the top of the rear brake master cylinder.

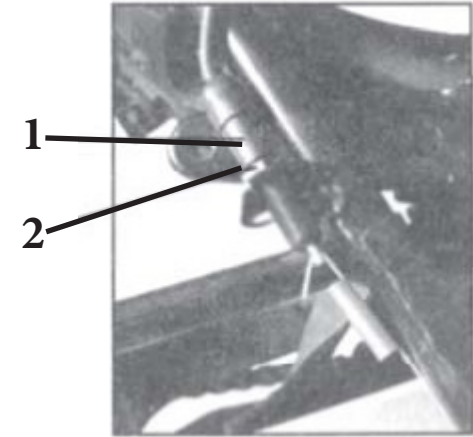

## Cleaning Your Motorcycle

To keep your motorcycle looking like new cleaning it periodically will help to maintain it's beauty and will assist in noticing damage, worn parts or leakage.

### Note:

When cleaning your motorcycle, DO NOT spray water on any of the following parts: wheels, ignition switch, handlebar switches, meter, hubs, muffler outlet, and the bottom of the fuel tank.

Plenty of clean water is needed, to wash the motorcycle thoroughly.

Wipe dry your motorcycle, start the engine and let it run for several minutes.

Lube the drive chain.

Braking performance may decline temporarily after cleaning your motorcycle.



## Periodic maintenance table

I: Inspection, cleaning, adjustment, lubricate or change C: Clean; R: Replace; A: Adjustment; L: Lubricate

Items	Times	Item Period	MILAGE (Note2)				Remarks
			600 mi	2,500 mi	5,000 mi	7,500 mi	
*	Fuel circuit			I	I	I	
*	Fuel filter		C	C	C	C	
*	Accelerator		I	I	I	I	
*	Carburetor choke valve			I	I	I	
	Air filter element	Note 1	C	C	R	C	
	Spark plug		I	I	I	I	
*	Valve clearance		I	I	I	I	
	<b>Engine Oil</b>	R each year	First 200mi R, 400 mi R, 600 mi R, every 1,250 miR				
	Engine oil filter mesh	R each year				C	
*	Carburetor adjustment		I	I	I	I	
**	Brake oil hose	R every 4 years		I	I	I	
**	Brake oil cup		I	I	I	I	
**	Brake oil	R every 2 years	Change every 2 years				

Items	Times	Item Period	MILAGE				Remarks
			600 mi	2,500 mi	5,000 mi	7,500 mi	
	Chain drive		I, L every 300 mi drive				
	Accumulator	Monthly	I	I	I	I	
	Brake system		I	I	I	I	
*	Rear brake lights switch		I	I	I	I	
*	Front lights beam selector	Monthly	I	I	I	I	
	Clutch		I	I	I	I	
	Side kick stand			I	I	I	
*	Front & rear damper		I	I	I	I	
*	Nut, bolt, fastener	Monthly	I	I	I	I	
**	Wheel/Tyre	Quarterly	I	I	I	I	
**	Steering handle bearing	6 months	I			I	

\*These repairs can be performed by the vehicle owner if they are familiar with the repair or adjustment outlined in this owner's manual. If not, have these repairs performed by an authorized SSR Motorsports dealer.

\*\* These repairs should be performed by a licensed and trained motorcycle mechanic.

Notes: 1.) Clean more frequently when the motorcycle is used in a dusty area.

2.) Recheck as per the indicated period in the table if the odometer is above 7,500 miles.

## **Storage of your motorcycle**

If your motorcycle needs to be stored for a long time (60 days or longer), necessary maintenance work shall be done to maintain the performance of the motorcycle and prolong service life. After a thorough cleaning, store it as follows:

- 1.) Remove all fuel from the fuel tank, fuel circuit and carburetor float bowl chamber.
- 2.) Change the engine oil and clean the engine oil filter mesh.
- 3.) Remove the empty fuel tank, fill it with a cup (about 80mL) of engine oil, shake the fuel tank to evenly cover the inner surface, then remove the residual engine oil and reinstall fuel tank.
- 4.) Remove the spark plug and pour about 1 spoon (15~20mL) of engine oil into the spark plug hole and reinstall the spark plug. Reinstall the spark plug then turn the engine over several times with the spark plug cap removed to coat the cylinder walls.  
Warning: When starting the engine with the starter, remove the high voltage wire of the spark plug, to prevent from sparking and ground it to the frame.
- 5.) Remove the drive chain, clean it with cleanser and lubricate it, reinstall the chain or preserve it in plastic bag (we recommend connecting the bag to the frame to keep it from being lost).
- 6.) Lubricate all control cables.
- 7.) Lift frame until both tires are elevated off of the floor. (This can be done with a front and rear wheel stand)
- 8.) Cap off the crankcase breather vent tube to prevent humidity from entering the crankcase.
- 9.) If the motorcycle is to be stored in a humid or salty location, paint a thin layer of engine oil onto the exposed metal surfaces. Do not paint any engine oil onto any rubber parts or the seat pad.
- 10.) Clean painted surfaces of the motorcycle, wax it and paint it with a layer of rust proof oil.
- 11.) Remove the battery and recharge it. Store it in a dry area and charge it once every month. Do not store it in a too hot or too cold location (below 32°F or above 90°F).
- 12.) Cover the motorcycle with a protective cover (no material with plastic cloth or other material coated with plastic), store it in a dry area with small temperature variation and little sunlight.

Note: Give thorough maintenance to your motorcycle before storage.

To use your motorcycle after long storage:

- 1.) Remove motorcycle cover and wipe the motorcycle clean, if the storage period is over 4 months, change the engine oil.
- 2.) Check the battery. Recharge and reinstall it, replace it if it will not take a charge or doesn't meet a load test.
- 3.) Completely clean the rust proof oil inside of the fuel tank and fill with fresh gasoline.
- 4.) Carry out a pre-ride inspection (refers to inspection before ride) and test drive the motorcycle on a non-crowded road for some time, to guarantee your safety.

ITEM	DATA
	125-21A
LXWXH WHEEL BASE MIN. GROUND CLEARANCE	1780mmX1033mmX775mm 1210mm 165mm
NET WEIGHT MAX LOAD	234 lbs. 331 lbs.
FRONT TIRE REAR TIRE	120/70-12 120/70-12
WHEEL HUB TYPE	Front and Rear Aluminum
BRAKE SYSTEM ENGINE OIL CAPACITY FUEL TANK CAPACITY	Front and Rear Disc Brakes 1.0 L 2.9 Gallons
MAX. SPEED MAX. POWER MAX. TORQUE FUEL ECONOMY	50 MPH 8.3 HP @ 7,500 RPM 6.9 ft. pounds of torque 2.4L/100km
RECOMMENDED FUEL RATING	91 Octane
RECOMMENDED ENGINE OIL	10W-40

ENGINE TYPE	1P52FMI-F
BORE X STROKE	52.4mmX 57.8mm
CYLINDER WORKING CAPACITY	125ML
COMPRESSION RATIO	9.7:1
SPARK PLUG CLEARANCE	0.6-0.7mm
VALVE CLEARANCE	INTAKE 0.05mm EXHAUST 0.05mm
BATTERY	12V4H
SPARK PLUG TYPE	D&RTC
IGNITION TYPE	DCDI
FUSE	10 AMP
RM AXLE WEIGHT	FRONT: 74KG REAR: 107 KG

**Note:** The above data was measured under specific test conditions, which may vary with different climates, road conditions and motorcycle maintenance during practical drive.



## **Exhaust Gas Purifying Apparatus**

This motorcycle adopts our newly developed exhaust gas purifying apparatus control which has reached the emission limit stipulated in GB14622- 2002 (Measurement Method For Pollutant Emission Limits of the Motorcycle).

Exhaust gas purifying apparatus control belongs to specific components. The muffler, carburetor and air-filter installed in this motorcycle has been matched by our company. Please contact your local dealer or appointed service station for repair or replacement parts if the motorcycle is damaged or any quality problems emerge. Please note that if the emission system components are replaced with any non-oem parts or if any modifications are made to these systems SSR Motorsports will not be responsible for warranty related repairs or replacements.