



Lazer5 Owner's Manual

Preface

Thank You for purchasing the Lazer5 50cc Moped, it will bring you years of pleasurable riding in a safe to operate package.

Riding a moped is one of the most exciting past times. For your safety, you should read this owner's manual carefully and follow these instructions before you ride.

This manual introduces regular maintenance and service, please follow these instructions, it will help you to keep your moped in good running order and functioning for years to come.

Our company never stops improving our quality and performance, this may lead to color or structural changes not outlined in this manual. We apologize if this brings you any inconvenience.

SSR Motorsports

Important Notice

1. Driver and passenger

This moped is designed for one driver and one passenger only.

2. Road condition for driving

This moped is only suitable for driving on roads.

3. Please read this manual carefully. Following the instructions outlined here will make your moped more durable and stable.

Please note the following words:

Warning: Means if you DO NOT follow the instructions, it could lead to serious damage for driver and passenger.

Caution: Means if you DO NOT follow the instructions, it may cause the person/s to be injured or damage to the moped.

Notice: Provide useful information

This user manual is proprietary to this moped. If this vehicle is sold, you should pass this manual on to the new owner together with the vehicle.

Do not copy or translate any part of this manual without the expressed written permission of SSR Motorsports.

This vehicle uses motorcycle grade engine oil.

---The special lubrication oil for motorcycles.

Special Notice

Warning: This moped must use the correct spec fuse, DO NOT use other spec fuses or operate without a fuse. Incorrect fuses may cause damage to the vehicle or fire.

Fuse position: next to the battery.

Fuse spec: Main Fuse 10 Amp.

If you blow the main fuse, before you replace the fuse you should perform a simple check of the vehicle for electrical shorts. If after replacing the fuse it blows again, send the vehicle to an authorized SSR dealership for inspection.

Notice:

* When changing the battery for the first time be aware of the positive and negative terminals. If you connect the battery to the wrong terminals check the main fuse immediately. Even if the main fuse is not blown you should take your motorcycle to a SSR dealership for inspection. An incorrect connection could lead to electrical system damage.

* Before replacing the fuse, turn off the ignition switch and remove the key.

* When replacing the fuse, use caution not to damage the bottom of the fuse, otherwise it may cause failure or other electrical system damage.

Forbidden Modifications:

Please do not change the original parts position, otherwise it will seriously effect vehicle performance and safety and may even cause the vehicle to operate improperly.

Modification examples include: electronic, emissions and/or fuel system, these changes may also be illegal. Our company will not take any responsibility for any of these changes made.

Table of Contents

Preface	
Important Notice	
Special Notice	
Safety Information.....	6
Safe Riding.....	6
Riding Gear.....	6
Helmet.....	6
Riding in Rain.....	6
Moped VIN Number.....	7
Part Description.....	8
Speedometer.....	9
Parts Operation.....	10
Key.....	10
Ignition Switch.....	10
Left Switch.....	10
Right Switch.....	11
Fuel Tank.....	12
Transmission Shifter Lever.....	12
Side Stand.....	13
Tool Kit.....	13
Rear Shock Absorbers.....	13
Mirrors.....	13
Gasoline and Engine Oil Information.....	14
Engine Break-In.....	14
Pre-riding Inspection.....	15
Riding your Moped.....	16
Starting the Engine.....	16
Starting.....	16
Riding Up Slopes.....	16
Using the Brakes and Stopping.....	16
Inspections and Maintenance.....	17
Maintenance Schedule.....	17/18
Engine Oil Change.....	19
Spark Plug.....	20
Throttle Cable Adjustment.....	20
Idle Adjustment.....	20
Carburetor.....	20
Drive Chain.....	21
Brakes.....	22
Tires.....	23
Air Filter Maintenance.....	23
Parts Lubrication.....	24
Battery.....	24
Fuse.....	25
Headlight.....	26
Bulb Replacement.....	26
Storage Information.....	27
Specification.....	28
Electrical Diagram.....	29

Safety information

Safety Regulations:

1. Before riding perform a pre-ride inspection of your vehicle to prevent accidents.
2. Rider must possess a legal driving license, and do not allow those without a driving license to use your moped.
3. To avoid accidents with other drivers the rider should:
 - Wear bright colored clothing.
 - DO NOT ride close to other vehicles.
4. Strictly obey traffic regulations, do not cut in and out of traffic rapidly.
5. Most accidents are caused by speeding, you should follow the speed limit at all times.
6. When making turns, use the turn signal indicators.
7. Use caution when riding in parking lots, the fast lane, and at intersections.
8. DO NOT modify your moped or remove parts, it may affect its function or void your warranty.
9. DO NOT add accessories that will affect riding your moped, DO NOT overload electronic parts.

Clothing:

1. For safety reasons, the rider must wear a helmet, eye protection, boots, gloves and a riding jacket/pants. A passenger should also wear the same gear listed above.
2. While riding, the exhaust system will be hot, DO NOT touch the exhaust system while riding or after riding until it has cooled completely.
3. DO NOT wear loose fitting clothing while riding, it could become caught on the motorcycle leading to an accident.

Helmet:

It is extremely important to wear a good quality helmet and glasses/goggles if not a full face helmet.

Riding in the rain:

Take special care when riding in the rain, the braking distances are twice as long when compared to dry riding.

Moped VIN Number

Vehicle Identification Number (VIN) and the engine number are used for registration of your moped. Please record your numbers for future use.

VIN Number is stamped into the vehicle frame on the right side of the steering stem (1). Engine Number is stamped on the lower engine crankcase on the left side (2). Product information label is on the vehicle frame on the right side below the seat (3).

VIN Number: _____

Engine Number: _____



Parts Description



- | | | |
|----------------------|-----------------------|------------------------|
| (1) Left Mirror | (2) Rear Brake Lever | (3) Left Side Switch |
| (4) Ignition Switch | (5) Speedometer | (6) Right Side Switch |
| (7) Right Mirror | (8) Front Brake Lever | (9) Throttle Grip |
| (10) Fuel Tank | (11) Oil Filler Cap | (13) Rider Pedals |
| (14) Rear Footrest | (15) Rear Drum | (16) Front Brake Lever |
| (17) Side Stand | Brake | (18) Center Stand |
| (19) Neutral / Drive | | |
| Switch | | |



Speedometer

(1) Turn Signal Indicators

When the left turn signal is switched on, the left indicator will flash.

When the right turn signal is switched on, the right indicator will flash.

(2) High Beam Indicator

When the high beam headlight is switched on, the high beam indicator will also turn on.

(3) Tachometer

When the engine is running the tachometer will display the current engine revolutions per minute displayed as 1X1,000 r/min.

(4) Ignition Switch

The ignition switch has two positions “ON” displayed as \odot and “OFF” displayed as \otimes . Turn the ignition switch to the “ON” position in order to start the engine using the start button.

(5) Trip Meter

This records the total driving distance but unlike the odometer it can be reset to track trip distance or distance until fueling is necessary. Rotate the knob on the left side to return it to zero.

(6) Odometer

This records the total driving distance.

(7) Speedometer

This indicates the driving speed in kph and mph.



Parts Operation

• Key

This vehicle comes with two keys, both can be use to start the moped and open all the locks. Please keep one key in a safe place. If you loose your key or need another one, please contact your closest dealer.



• Ignition Switch

Warning:

DO NOT turn off the key or remove it while riding, otherwise you could loose control of the vehicle.

“⊗” logo.....when the key is on “⊗” position, there is no power and cannot start engine, the key can be removed from the switch.

“○” logo.....when the key is on “○” position, it has electrical power and the engine can be started, the key cannot be removed.



• Steering Lock

To prevent theft, when you park please use this handlebar lock function. Turn the handlebars to the left, insert the key into the steering lock and turn the key to the right, it will lock the handlebars. Then you can remove the key from the steering lock.

Notice:

When parking your moped please lock the handlebars and remove the key to prevent theft. Always park your moped in an appropriate place.

• Left Switch Group

(1) Rear Brake Lever

When starting the engine pull in either brake lever to prevent the vehicle from lurching forward.

(2) Horn Button

When you press the horn button, the horn will sound.



(3) Hi / Low Beam Switch

when the switch is in “” position, the high beam is on, and the speedo high beam indicator light will be on as well.



When the switch is in “” position, the low beam is on.

(4) Turn Signal Switch

Press the left side turn signal “” the left side turn signal light will flash. Press right side turn signal “” the right side turn signal light will flash. To turn off the turn signal, return the switch to the middle position.

Warning:

When changing lanes or turning, always use the turn signal indicator. Shut off the turn signal as soon as you have completed your turn.

• **Right Switch Group**

(1) Hazard Light Switch

When this switch is in the “” position, the front and rear turn signals will blink in unison.

When the switch is in the “•” position, the front and rear turn signals will be off.

Warning:

Only use the Hazard Light Switch for emergency situations. Don't use this switch for any other reason other than an emergency.

(2) Start Button

When you press this “” button, the engine will start.

(3) Throttle Grip

The throttle grip controls the speed of the engine. When you want to accelerate, turn the grip toward the rear of the motorcycle.

(4) Front Brake Lever

When braking, please grip the right side lever gradually.

(5) Headlight Switch

Use this switch to turn off or on the headlight.



DO NOT turn off the headlight while the engine is running and the moped is in use.

• Fuel Tank

Your moped is not equipped with a fuel gauge, make sure to refuel your moped before you run out of fuel.

First open the dust cover and then insert the key and turn it counterclockwise to unlock. Turn the cap counterclockwise to remove it. After filling with gasoline reinstall the fuel tank cap by turning it clockwise. Then turn the key clockwise to lock the cap.



Your moped is also equipped with a fuel petcock valve. This valve has three positions, On, Off, and Reserve. If left on the On position when it runs out of gas it can be switched to Reserve for a small amount of additional fuel.

ON = Upper Symbol

OFF = “ • ” Symbol

Reserve = Lower Symbol

Warning:

Please **DO NOT** overfill the fuel tank. **DO NOT** splash gasoline on the engine while hot, it is very dangerous.

• Gear Shift Lever

This vehicle is equipped with a neutral / drive switch to enable pedaling of your moped. The transmission is in the neutral position when the lever is pressed toward the front of the moped, drive is engaged when the lever is pressed toward the rear of the moped.

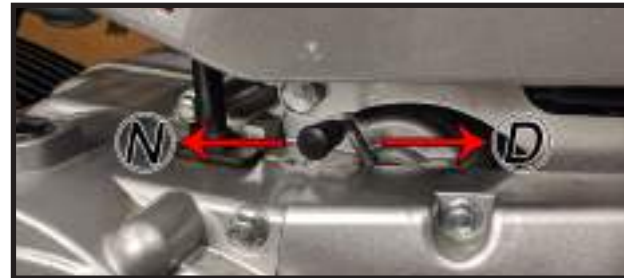

Caution:

DO NOT switch the transmission position when the vehicle is moving. Only move the lever when the moped is stationary. When the engine is in neutral, there is no neutral indicator lamp.

- **Side Stand**

The side stand is on the left side of the moped, be sure to use the stand when parking the vehicle.

Caution:

Don't park your moped on a slope, otherwise your moped may fall over.

- **Center Stand**

The center stand is on the left side of the moped behind the side stand. Use the center stand when servicing the moped or if more secure footing is needed.

- **Tool Kit**

Your moped includes a tool kit. The tool kit includes a screw-driver, screwdriver handle, a 14/12 wrench, a 10/8 wrench, an Allen wrench, and a spark plug socket.

- **Rear Shock Absorbers**

This vehicles rear shock absorbers include a spring and liquid dampening. The shock absorber can be adjusted according to different road conditions. To adjust, use a spanner wrench to rotate the collar at the bottom of the spring on the rear shock. Use the diagram below for reference.



- **Adjustable Mirrors**

To adjust the mirrors, loosen the bottom nut if needed to move the mirror in closer. Otherwise adjust the head of the mirror into a position where you can see clearly behind you.

Gasoline and Oil Information

• Gasoline

Please use unleaded gasoline. Please use octane of #91 or above.

Caution:

Use only unleaded gasoline as this will prolong the life of the spark plug.

• Oil

Please use SJ or above SJ grade engine oil. Use the viscosity chart below to determine the best viscosity for your region.

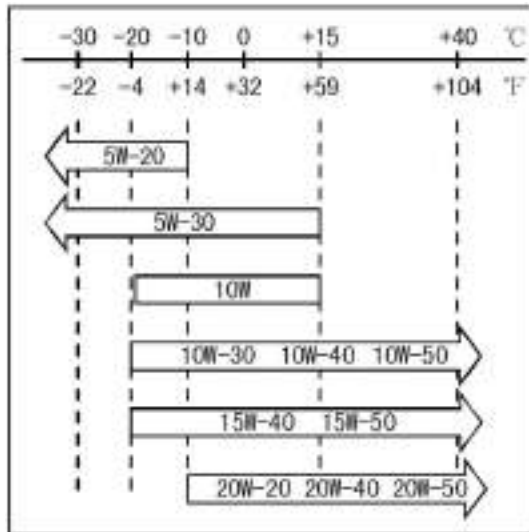

Engine Break-In

• Top Speed

During the first 1,000 miles of operation, do not run the engine at high speed or accelerate too quickly. RPM's should not exceed 80% of the maximum RPM.

• Engine Speed Change

Speed should always be variable, it should change frequently, it helps the engine parts to break-in smoothly.

• Avoid Long Distances at Low Speeds

To help prevent damage and to assist the engine break-in period long distance travel at low speeds should be avoided until the engine is past the first 1,000 miles of use.

The chart below shows the recommended maximum RPM's during the break-in period.

First 500 miles	Under 5,000 RPM
First 1,000 miles	Under 6,000 RPM
Over 1,000 miles	Under 7,500 RPM

• **Before Riding**

Check the engine oil level before operating your moped every time.

• **First Service Maintenance**

The first 600 mile maintenance is the most important service to have performed. Please tighten all hardware and change the oil.

Caution:

600 mile maintenance should be performed according to this manual. Please pay special attention to the “Caution” and “Warning” notes.

• **Special Notice**

Once your moped has 200 miles on it return the dealership for an oil change. Then after 600 miles return to the dealership for an oil change and air filter cleaning. After the 600 mile service the next oil change will be done at 1,500 miles or one year, whichever comes first.

Check engine oil level frequently.

• **Before Riding**

Before riding check the items in the chart to the right.

Item Check	Points
Handlebar	1) Stable 2) Turning Flexibility 3) Not Loose
Brakes	1) Brakes feel firm 2) No fluid leaks
Tires	1) Correct Air Pressure 2) Check Tire Wear 3) No Cracks or Damage
Fuel	Enough for planned travel
Lights	Check function of all lights
Indicators	Check high-beam, neutral light, and turn signal indicators
Horn	Check Function
Oil	Check for correct level
Throttle	1) Rotates Freely 2) Engine Accelerates
Drive Chain	1) Correct Adjustment 2) Lubrication

Riding your Moped

• Starting the Engine

Turn the key to the “⊙” position, the engine can be started in both drive and neutral.

• Start

Apply the front brake by pulling in the lever, then press the start button marked “⊕” until the engine starts and runs, you will want to use the choke if the engine is cold.

• Riding on Inclines

When riding up and incline, your mopeds speed will decrease and it may stall. When this happens you will want to also pedal your moped to assist your hill climb.

• Using the Brakes and Parking

You should completely close the throttle and gradually apply the front and rear brakes evenly when bringing your moped to a stop.

Caution:

New riders tend to use only the front or rear brake, this will cause either system used to wear out the brake pads/shoes more quickly. Using only the front or rear brake will also increase braking distances.

Warning:

Only using the front or rear brakes is dangerous, especially in wet conditions. This can cause loss of control. Always apply both brakes evenly. **DO NOT** brake suddenly as this may cause wheel lock up and vehicle skidding.

Your moped should be parked on flat ground whenever possible. If your moped must be parked on an incline, please lock the handlebars and angle the front wheel into the curb to keep it from rolling. You can also use the center stand when parking on an incline but you will need to face the front of your moped up the hill, not down.

Maintenance

The following chart shows the maintenance schedule. When each service interval is reached you must perform the services outlined below. Suspension, Engine, Electronic System, Carburetor and Tires are key components. These items may require a professional technician to perform.

Maintenance Symbols: I: Inspect/Adjust C: Clean R: Replace A: Adjust L: Lubricate T: Torque

Maintenance period Maintenance content	Odometer (Mi)																	
	200	600	1200	2000	2600	3200	4000	4400	5000	5600	6200	7000	7600	8200	8800	9400	Everyday check before riding	
Oil for crankcase	Running-in period every 200 R		Every 1,200 R														I	
Air filter	Every 2,600 clean filter if necessary please change																	
Spark plug		I			I				I									
Valve clearance		I			I				I									
Gasoline filter					C				C									
Brake Fluid																		I
Drive Chain	Every 600 I, A																	
Nuts, Bolts, Fasteners	T						T						T					T

Maintenance period Maintenance content	Odometer (MI)																
	200	600	1200	2000	2600	3200	4000	4400	5000	5600	6200	7000	7600	8200	8800	9400	Everyday check before riding
Drive Chain	Every 600 mi = I. L. A																
Friction disk					I				I				I				
Brake system		I. A			I. A				I. A				I. A				
Brake					I				I				I				
Front headlight beam adjustment					I				I				I				
Clutch		I			I				I				I				
Stand					I				I				I				
Suspension					I				I				I				
Screw		I							I								
Wheel		I			I				I				I				
Turning system		I											I				

- * When the mileage exceeds the highest mileage on the table, please restart the table at the 600 mile interval
- * If riding in a dusty environment clean/lube/oil the air filter and chain more frequently.

• Oil Change and Oil Level Check

Check the engine oil level before you start the engine. When checking the oil level, make sure the vehicle is on flat ground. Remove the dipstick and wipe it clean with a rag. Reinsert the dipstick without screwing it in. Remove the dipstick and observe the oil level, it should be at the upper area of the XXXXX pattern.



Caution:

The best time to change the oil is when the engine is warm. The moped should be supported vertically on the center stand so the warm oil will exit the engine quickly.

The engine oil capacity is 700cc.

When draining the oil, place an oil pan under the drain plug, then remove the drain plug. (1). When completely drained reinstall the oil drain bolt.



Torque the bolt to 20-25Nm.

- (2.) Fill the engine with 700cc's of fresh oil.
- (3.) Use a clean, dry rag to clean the oil filler cap/dipstick and engine cover surface.
- (4.) Check the oil level with the dipstick and verify it is at the upper portion of the XXXXX.
- (5.) Apply a small amount of oil to the dipstick o-ring then screw it into place and tighten by hand.

Caution:

Replace the oil dipstick o-ring and the oil drain bolt crush washer every time you change the oil to avoid leakage.

- (6.) Start the engine and allow the engine to idle for a few minutes then turn off the engine.
- (7.) Remove the dipstick and clean it with a rag. Reinsert the dipstick without screwing it in and then remove it to observe the oil level.
- (8.) If the oil level is sufficient, reinstall the dipstick, if not repeat step 5 and 7 until the oil level is correct.

- **Spark Plug**

Use a small wire brush or a spark plug cleaner to clean the carbon deposits from the plug in the first 600 miles of use and after every 2,600 miles of riding. Every 5,000 miles, the spark plug should be replaced.



Spark Plug Type: NGK C7HSA

Caution:

DO NOT over torque the spark plug. Over torque could lead to cylinder head thread damage.

- **Throttle Cable Adjustment**

1. Turn the throttle grip to check if it reacts quickly or not.
2. Check the throttle cable freeplay, it should have 10° to 15° of freeplay at the handlebar grip.



Please follow these steps to adjust the throttle grip travel distance.

1. Pull back the throttle cable cover.
2. Loosen the nut (1).
3. Adjust the screw (2) until 10°~15° of travel is achieved.
4. Tighten the nut (1).



- **Engine Idle / Fuel Screw Adjustment**

Use the idle adjustment screw to raise or lower the idle as needed.



• Drive Chain

The service life of the drive chain depends on your maintenance frequency. Improper or lack of maintenance will cause a shorter life span.

• Adjusting the Drive Chain

Every 600 mi, adjust the drive chain to make the chain sag 10 - 20mm. Based on your riding habits you may need to adjust the chain more frequently.

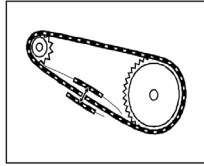

Warning:

The drive chain should be inspected before every ride. The above adjustment interval is just a suggestion. A loose chain may cause engine damage or fall off.

Follow these steps to adjust the drive chain:

1. Use the center stand.
2. Loosen the axle nut (1).
3. Loosen the adjuster nut (2).
4. Turn the adjuster nut (3) left or right to adjust the chain to proper slack.

When adjusting the chain, be sure to make the adjustment evenly from side to side.



To help you make the adjustment, the swing-arm is marked with notches you can use for reference from side to side. The chain should have 10-20mm of slack. When you have completed the adjustment tighten the axle.

Caution:

When replacing the chain, inspect the sprockets also, if worn replace them.

Drive chain inspection check list:

1. Chain rollers are seized.
 2. Excessive sprocket wear.
 3. Is the chain rusty or dry.
 4. Is the chain damaged.
 5. Uneven chain stretch (tight spots).
 6. Still loose at maximum adjustment.
- If the chain has one of the above problems, it may be caused by the sprockets. If so check the following items:

1. Sprockets may have excessive wear.
2. Broken or missing sprocket teeth.
3. Sprocket bolts may be loose.

• Lubrication of the Drive Chain

Only use motorcycle drive chain lube to lubricate the chain, DO NOT use motor oil or WD-40.

- **Brake**

This vehicle uses a front disc and rear drum brake system. Correct operation of the brakes is very important for safe riding. The brake system should be regularly inspected to ensure the utmost safety.

- **Rear Brake Adjustment**

Rear brake lever freeplay is 10-20mm.



Turn the cable adjuster nut to make the adjustment at the rear drum brake cable adjuster shown above.

- **Brake Pads / Shoes**

Inspect the front brake pads and rear brake shoes. Once they have reached the minimum thickness, replace them.

- **Brake Fluid Level**

As the brake pads wear, the brake fluid will decrease as the fluid fills the brake piston. The front brake master cylinder



is on the right side of the handlebars. If the fluid level is below the minimum mark add fluid to the reservoir. Make sure the fluid level is above the lower mark. If the fluid is below the lower mark, please add brake fluid. Check the brake fluid level regularly.

Caution:

This vehicle uses DOT 4 brake fluid. **DO NOT** use fluid from an open container or of a different type. Please **DO NOT** get brake fluid on painted surfaces as it will damage them.

- **Brake System**

Please inspect the brake system daily.

1. Check for brake fluid leaks.
2. Check levers for proper brake pressure/adjustment.

3. Check brake pad wear.

Warning:

If the brake system or brake pads/shoes require replacement take your vehicle to an authorized dealer. Once replaced be sure to pump up the brake system.

• **Tires**

Correct air pressure in the tires will provide a stable and comfortable ride.

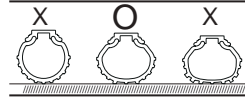

Front Tire Pressure	26 psi
Rear Tire Pressure	28 psi

Caution:

Please check the tire pressures when the tires are “cold.”

When the middle pattern of the tires reach the last 2mm of tread replace the tires. See the chart below for the minimum tread wear depths.

Minimum Tread Depth	
Front Tire	2mm
Rear Tire	2mm

Warning:

DO NOT repair damaged tires. Underinflated or overinflated tires will lead to abnormal or premature wear. These conditions could lead to instability or accidents.

• **Air Filter Maintenance**

The air filter should be cleaned regularly. If operating your moped in dusty environments clean the air filter more frequently.

1. Remove the airbox from the back of the carburetor.
2. Remove the 2 screws securing the two halves of the airbox and remove the filter.



Caution:

DO NOT use gasoline or other flammable liquids to clean the air filter element.

• Parts Lubrication

Proper lubrication will keep your moped and every single part running smoothly and increase durability. After long rides or rain, we suggest you do lubrication maintenance. The main points are as follows:



Grease the items below:

- (1) Brake Lever Pivots
- (2) Side Stand
- (3) Center Stand
- (4) Throttle Cable
- (5) Speedometer Drive

• Battery

The battery is under the left side cover and is a non-servicable type. Once the battery has been filled with electrolyte you cannot add any more. To remove the battery please follow these steps:



- A. Turn off the ignition switch
- B. Remove the left side cover.
- C. Remove the battery bracket.
- D. Remove the negative pole (-) first, then the positive pole (+).

Caution:

When installing the battery be sure to connect the correct terminals to the correct posts. The red cable must connect to the positive pole (+) and the black cable to the negative pole (-). Turn off the power any time you install or remove the battery.

• **When changing the battery note the following:**

Be sure the battery matches the one removed from the motorcycle. If an incorrect battery is used it could cause damage to the vehicle or electrical system.

Warning:

The battery and electrolyte contains poisonous chemicals and materials. Use gloves when handling batteries and keep them out of the reach of children. The battery can cause sparks, flames and produces poisonous gases. Operate in a well ventilated room and rinse all surfaces exposed to electrolyte immediately with water.

• **Fuse Replacement**

The fuse holder is located in the battery box area, under the left side cover. Replace fuses only with the same amp rating. If a fuse blows many times, take your moped to a dealer for a dead short inspection.



Fuse Specification: 10 amp

Warning:

When checking or replacing fuses be sure to turn off the ignition switch. Always use fuses of the same specification as removed, otherwise serious electrical faults could occur which could lead to fire or loss of engine power.

• Headlight Adjustment

The headlight beam can be adjusted vertically. The adjustment bolts (1) are located on both sides of the headlight bucket. Using a 13mm wrench loosen both side bolts (1) and adjust the beam to the desired position, then tighten the bolts.



Caution:

When adjusting the beam, the rider should sit on the seat and keep the moped in a vertical position.

• Bulb Replacement

When replacing a blown/broken bulb be sure to use a bulb of the same wattage. A bulb of higher wattage can cause melting of the bulb, lens, or electrical faults.

Headlight Parking Lamp Replacement

1. Remove the two bolts (1) as in the picture.



2. Move the rubber dust boot back to expose the bulb.

3. Unclip the headlight bulb (1) and replace with a 12V 35/35W bulb.

4. Replace the parking lamp bulb (2) by pulling it.



• Taillamp Bulb Replacement

1. Remove the two bolts securing the taillight lens.

2. Push the bulb in and rotate it left to remove it from the base.

3. Install a new bulb by pressing in and turning it to the right.



• **Front/Rear Turn Signal Bulb Replacement**

1. Remove the screw from the backside of the turn signal housing.
2. Remove the lens, move the screw side of the lens outward to release the inner tab.
3. Remove the bulb by pressing in and turning it to the right.
4. Install a new 12V 10W bulb, press it in and turn it to the left.
5. Reinstall the lens and secure with the screw you removed in step 1.



• **Vehicle Storage Information**

If you plan to store your moped for an extended period of time take these steps to protect your vehicle:

1. Change the engine oil.
2. Lube the drive chain.
3. Drain the fuel tank and fuel system of any gasoline (this includes the carburetor).

Caution:

Gasoline stored for long periods of times will deteriorate. If storing fuel for longer than 30 days use a stabilizer product.

Warning:

Gasoline is extremely flammable, when draining the fuel please keep away from fire or sparks that could ignite the fuel.

4. Remove the spark plug and fill the cylinder with 15-20cc's of engine oil then turn the engine over several times. Reinstall the spark plug when complete.
5. Remove the battery, store it in a cool, dry, shaded area and maintain the charge.
6. Clean and dry your moped.
7. Set front and rear tire pressures.
8. Cover the moped indoors in an area where the temperature doesn't fluctuate drastically.

• **To prepare unit for use after storage**

If stored over 4 months, change the engine oil. Test the battery and all other parts before use.

Specifications

Size & Weight

Length.....70.27in.
Width.....26.77in.
Height.....40.15in.
Wheel Base.....47.24in.
Weight.....180.77 lbs.
Max load.....330 lbs. (incl. rider)

Engine

BoreXStroke.....39 x 41.4mm
Displacement.....49.4ml
Max Power.....N/A
Max Torque.....N/A
Ignition.....CDI
Compression Ratio.....8:1
Start.....Electric
Idle Speed.....1,500 RPM

Transmission

Clutch.....Centrifugal
Transmission.....Automatic w/ Neutral
Intake valve clearance.....0.03mm
Exhaust valve clearance.....0.05mm

Frame

Front suspension.....Hydraulic/Spring
Rear shock absorber.....Preload Adjustable Spring
Front brake.....Hydraulic Disc
Rear brake.....Drum
Front tire.....2.25-17
Rear tire.....2.50-17

Electrical System

Battery.....12V 4Ah
Magneto.....Permanent Magnet
Headlight.....12V 35W/35W
Parking Light.....12V 5W
Taillight.....12V 5W/21W
Turn Signal.....12V-10W x 4
Neutral Light.....12V 3.4W
Turn Signal Indicator.....12V 3.4W
Meter Light.....12V 3.4W
High Beam Indicator.....12V 3.4W
Carburetor.....16mm
Fuse.....10amp (round type)

Capacity

Fuel tank.....0.74 gallon
Engine oil volume.....700cc (at change)

Performance

Max speed.....N/A
Climbing ability.....>16°
Braking distance.....<23ft(19mph)
Loading.....One Rider, One Passenger
Gasoline type.....91#

ELECTRICAL DIAGRAM

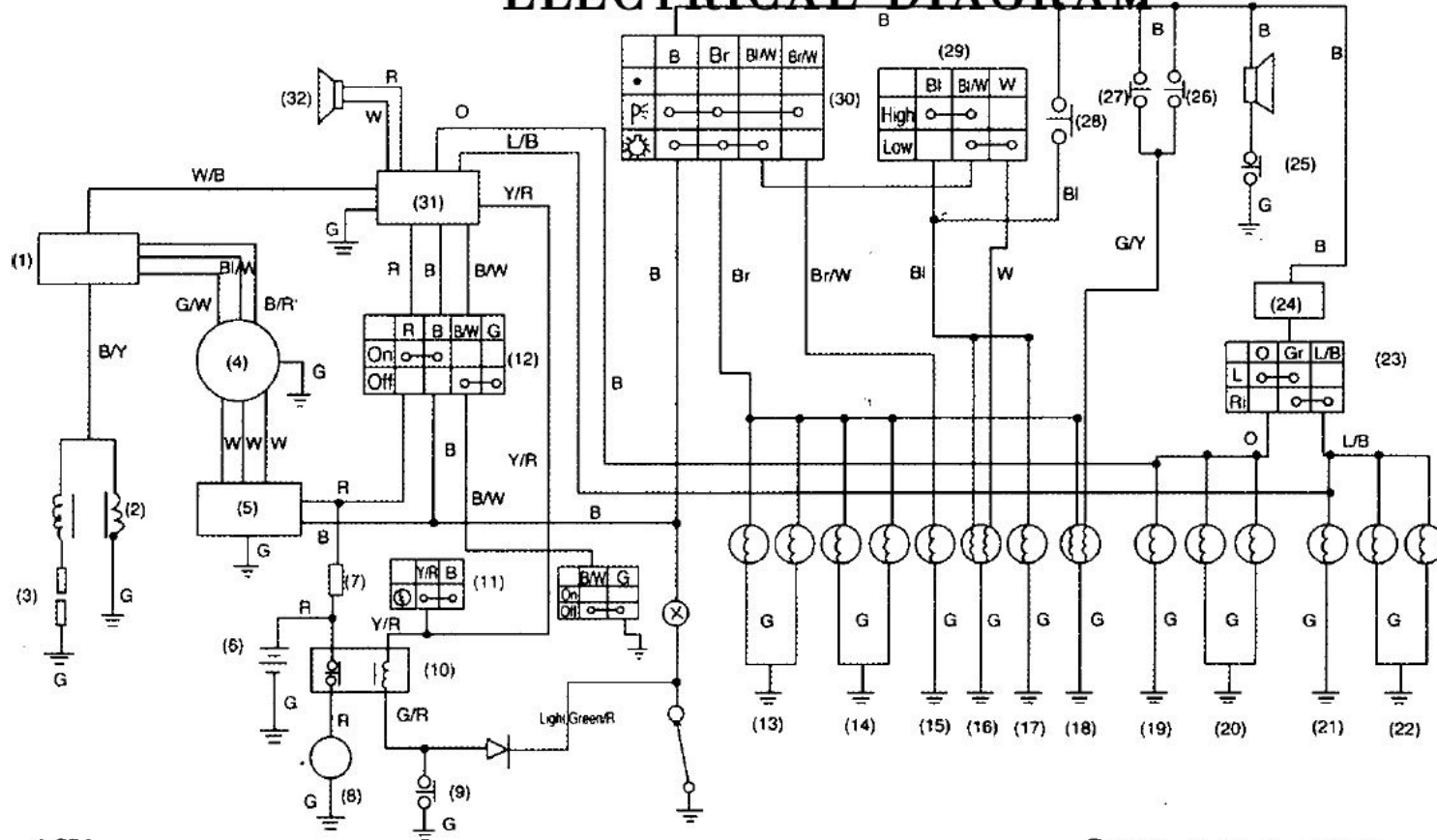

- 1.CDI
- 2.Ignition coil
- 3.Spark plug
- 4.Generator
- 5.Voltage regulator
- 6.Battery
- 7.Overflow protector
- 8.Start motor
- 9.Clutch switch
- 10.Start relay

- 11.Power Switch
- 12. Ignition
- 13.braking light
- 14.Meter light
- 15.front Position Light
- 16.Headlight
- 17.High beam indicator
- 18.Taillight/braking light
- 19.Left turn indicator
- 20.Left turn Light

- 21.Right turn indicator
- 22.Right turn light
- 23.Turnlight switch
- 24.Flasher
- 25. Worm switch
- 26.Rear braking switch
- 27.Front braking switch
- 28.Overtaking Light Switch
- 29.Light changing Switch
- 30.Illuminator switch
- 31.Burglar alarm

32.Horn

- | | | | |
|----------|---------|----------|----------------|
| Gr-grey | B-Black | Y-Yellow | P-Pink |
| L-Left | W-White | BL-Blue | L/B-Light Blue |
| Ri-Right | R-Red | O-Orange | Br-Brown |

