



READ THIS MANUAL CAREFULLY  
BEFORE YOU USE THIS VEHICLE!  
It contains important safety information.

# OWNER'S MANUAL

PLEASE CHECK YOUR LOCAL RIDING LAWS AND  
REGULATIONS BEFORE OPERATING THIS VEHICLE.  
This UTV should not be ridden by anyone under 10 years of age.

215mm\*140mm

**⚠ WARNING**

Improper use can result in SEVERE INJURY or DEATH

			
---	---	---	---

ALWAYS USE AN APPROVED HELMET AND PROTECTIVE GEAR FOR DRIVER AND PASSENGER	NEVER USE ON PUBLIC ROADS	NEVER CARRY MORE THAN 1 PASSENGER	NEVER USE WITH DEUGS OR ALCOHOL
--	---------------------------------	---	---------------------------------------

**NEVER** operate:

- without proper ATV teaining or instruction
- at speeds too fast for your skills or the conditions
- on public roads-a collision can occur with another vehicle
- with a passenger unless pasenger seat is securely in place.

**THE OPERATOR MUST ALWAYS:**

- use proper riding techniques to avoid overturns on hills and rough terrain and in turns
- avoid paved surfaces-pavement may seriously affect handling and control
- reduce speed and use ectra caution at all times when carryig a passenger-dismount passenger when conditions require
- make sure passenger reads and understands this label and passenger safety label

LOCATE AND READ OPERATOR'S MANUAL.  
FOLLOW ALL INSTRUCTIONS AND WARNINGS

## WARNING

- Operation of this UTV by children under the age of 10 increase if the risk of severe injury or death.
- An adult supervision required always.
- Never permit children under age 10 to operate this UTV.
- Overloading can adversely affect vehicle handling.
- Operator use only, passengers prohibited.
- This vehicle is designed and manufactured for OFF-ROAD use only.
- Driving on public streets roads or highways is illegal.
- Always wear helmet and other protective equipment.
- Do not operate this vehicle after consuming Alcohol Drugs.
- Gasoline flammable, when refueling. Please shut off engine to avoid sparks and open flame.
- Read owner's manual carefully before riding. Keep owner's manual with vehicle.



### WARNING

Read, understand, and follow all of the instructions and safety precautions in this manual and on all product labels.

Failure to follow the safety precautions could result in serious injury or death.



### WARNING

The engine exhaust from this product contains chemicals known to the State of California to cause cancer, birth defects or other reproductive harm.

## PAY ATTENTION TO YOUR SAFETY

This section presents some of the most important information and recommendations to help you ride your UTV safely. Please take moments to read these pages. This section also includes information about the location of safety labels on your UTV.

### Important safety information

Your UTV can provide many years of service and pleasure-if you take responsibility for your own safety and understand the challenges you can meet while riding.

There is much that you can do to protect yourself when you ride. You'll find many helpful recommendations throughout this manual. The following are a few that we consider most important.

### Follow the age recommendation

The minimum recommended age of this UTV model is 10.Children under age 10 should never operate this vehicle.

### Always wear a helmet

It's a proven fact: helmets significantly reduce the number and severity of head injuries. So always wear an approved motorcycle helmet. We also recommend that you wear eye protection, sturdy boots, gloves, and other protective gear.

### Ride off-road only

Your UTV is designed and manufactured for off-road use only. The tires are not made for pavement, and the UTV does not have turn signals and other features required for use on public roads. If you need to cross a paves or public road, get off and walk your UTV across.

### Take time to learn & practice

Even if you have ridden other UTV, take time to become familiar with your skills and get accustomed to the UTV's size and weight.

Because many accidents involve inexperienced or untrained riders, we urge all riders to take a training course approved by the UTV safety institute.

Contact an authorized UTV dealer to find out about the training courses nearest you.

### **Be alert for off-road hazards**

The terrain can present a variety of challenges when you ride off-road.

Continually “read” the terrain for unexpected turns, drop-offs, rocks ruts, and other hazards. Always keep your speed low enough to allow time to see and react to hazards.

### **Ride within your limits**

Pushing limits is another major cause of UTV accidents. Never ride beyond your personal abilities or faster than conditions warrant.

Remember that alcohol, drugs, fatigue, and inattention can significantly reduce your ability to make good judgments and ride safely.

### **Don't drink and ride**

Alcohol and riding don't mix. Even one drink can reduce your ability to respond to changing conditions, and your reaction time gets worse with every additional drink. So don't drink and ride, and don't let your friends drink and ride either.

### **Keep your UTV in safe condition**

It's important to keep your UTV properly maintained and in safe riding condition. Having a breakdown can be difficult, especially if you are stranded off-road far from your base. To help avoid problems, inspect your UTV before every ride and perform all recommended maintenance.

Your UTV comes with a hangtag and several labels containing important safety information. Anyone who rides the vehicle should read and understand this information before riding.

The labels should be considered permanent parts of the vehicle. If a label comes off or becomes hard to read, contact your dealer for replacement.

## **GUIDELINES ON SAFE DRIVING**

1. When approaching corners or bends to reduce speed. Upon the completion of turn, may gradually increase the speed.
2. When crossing of turn, may gradually increase the speed.
3. Brake hose may be wet and useless so before walking away you should check all the brake system and clean the ends.

## INSTRUMENTS & CONTROLS

This section shows the location of all indicators and controls you would normally use before or while riding your UTV.

These items listed on this page are described in this section. Instructions for other components are presented in other sections of this manual where they will be most useful.

## WELCOME

### **Dear parents:**

We believe your children should have the opportunity to enjoy The Way Out, experience along with you. We encourage you to teach your children to ride safely, and to help ensure the future of recreational sports, please teach them to show respect for our environment and for the rights of others while operating the vehicle.

This vehicle is not a toy and can be hazardous to operate. We've provided this owner's manual to help you and your children learn about the safe operation and care of your new vehicle. Before your children drive or ride in the vehicle, please read and make sure they read the owner's manual. Make sure they understand that the vehicle must be used under adult supervision at all times.

After reading the owner's manual, help your child practice the New Operator Driving Procedures on pages 47-48.

Never allow a child age 10 and under to operate or ride as a passenger in this vehicle. Children differ in skills, physical abilities and Judgment.

Please supervise the use of the vehicle at all times. Permit continued use only if you determine that your child has the ability and maturity to operate safely.

Make sure your child is not too tall to ride safely in this vehicle. See page 17. The vehicle's speed control system allows limiting vehicle speed for new and inexperienced operators. Please see page 40 for more information. The preventive maintenance program outlined in this manual is designed to ensure that all critical components on your child's vehicle are thoroughly inspected at specific intervals. Always all of the instructions and recommendations in this manual to ensure the vehicle remains in safe operating condition at all times.

Your vehicle is not designed for adult use. Serious damage may occur if the maximum weight capacity is exceeded. Refer to vehicle labels and to the specifications section beginning on page 97 for the maximum weight capacity.

**Dear Young Operators:**

Before you ride your new vehicle, there are some important things that you need to know. You must learn how to keep yourself and those around you safe while you're riding.

You parents want you to be safe while you enjoy riding your new vehicle, and that's why it's very important that you read this owner's manual. Make sure you understand and follow all of the instructions and warning in the owner's manual. Ask your parents to explain anything you don't understand.

Your safety and the safety of others is the most important thing to think about at all times. Pay attention you



see this symbol:

This is the safety alert symbol. When you see this symbol on your vehicle or in this manual it means **PAY ATTENTION** because you could die or be seriously injured if you don't follow the instructions.

After reading the owner's manual, complete the New Operator Driving Procedures on pages 47-48. Show your parent that you understand how to drive safely.

Enjoy riding your new vehicle!

## TABLE OF CONTENTS

<b>Introduction.....</b>	<b>11</b>
<b>Safety.....</b>	<b>14</b>
<b>Features and Controls.....</b>	<b>29</b>
<b>Operation.....</b>	<b>41</b>
<b>Emission Control Systems.....</b>	<b>57</b>
<b>Maintenance.....</b>	<b>58</b>
<b>Specifications.....</b>	<b>97</b>
<b>Troubleshooting.....</b>	<b>99</b>
<b>Maintenance Log.....</b>	<b>103</b>
<b>YOUR WARRANTY RIGHTS AND OBLIGATIONS.....</b>	<b>104</b>

## INTRODUCTION

The following signal words and symbols appear throughout this manual and on your vehicle. Your safety is involved when these words and symbols are used. Become familiar with their meanings before reading the manual.



The safety alert symbol indicates a potential personal injury hazard.

### **WARNING**

A **WARNING** indicates hazardous situation which, if not avoided, may result death or serious injury.

### **CAUTION**

A **CAUTION** indicates a hazardous situation which, if not avoided, may result death or serious injury.

### **CAUTION**

A **CAUTION** indicates a hazardous situation which, if not avoided, may result in minor or moderate injury.

### **NOTICE**

A **NOTICE** indicates a situation that may result in property damage.



The Prohibition Sign indicates an action **NOT** to take in order to avoid a hazard.



The Mandatory Action Sign indicates an action that **NEEDS** to be taken to avoid a hazard.

## INTRODUCTION

### **! WARNING**

Failure to follow the warnings and safety precautions contained in this manual can result in severe injury or death. Your vehicle is not a toy and can be hazardous to operate. This vehicle handles differently than cars, trucks or other off road vehicles. A collision or rollover can occur quickly, even during routine maneuvers like turning, or driving on hills or over obstacles, if you fail to take proper precautions.

- Read this owner's manual. Understand all safety warnings, precautions and operating procedures before driving the vehicle. Keep this manual with the vehicle.
- Never operate this vehicle without proper instruction. All operators and supervising adults must watch the instructional video that was provided with the vehicle.
- Complete the New Operator Driving Procedures outlined on pages 47-48.
- Always follow the age guidelines for your vehicle. Operation is prohibited for anyone age 10 and under. Never operate with a passenger age 10 and under.
- Never allow a guest to operate this vehicle until the guest has watched the instructional video and has completed the New Operator Driving Procedures on pages 47-48.

## INTRODUCTION

### Vehicle identification Numbers

Record your vehicle's identification numbers and key number in the spaces provided. Remove the spare key and store it in a safe place. An ignition key can be duplicated only by ordering a key blank and mating it with one of your existing keys.

The ignition switch must be replaced if all keys are lost.



Vehicle identification Number

Engine Serial Number  
(Under the back cover)



Vehicle Model Number: \_\_\_\_\_

Vehicle identification Number: \_\_\_\_\_

Engine Serial Number: \_\_\_\_\_

## SAFETY

### Equipment Modifications

Your vehicle is designed to provide safe operation when used as directed. Modifications to your vehicle may negatively impact vehicle stability. Failure of critical machine components may result from operation with any modifications, especially those that increase speed or power. This vehicle may become less stable at speeds higher than those for which it is designed. Loss of control may occur at higher speeds.

Do not install on any equipment that may increase the speed or power of the vehicle, or make any other modifications to the vehicle for these purposes. Any modifications to the original equipment of the vehicle create a substantial hazard and increase the risk of bodily injury.

The warranty on your vehicle is terminated if any equipment has been added to the vehicle, or if any modifications have been made to the vehicle, that increases its speed or power.

The addition of certain accessories may change the handling characteristics of the vehicle. Use only approved accessories, and familiarizes you with their function and effect on the vehicle.

## Safe Riding Gear

Always wear appropriate clothing when riding your vehicle. Wear protective clothing for comfort and to reduce chance of injury.

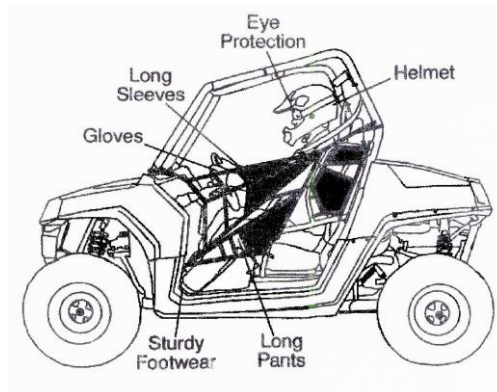

### Helmet

Wearing a helmet can prevent a severe head injury. Whenever riding this yours vehicle, always wear a helmet that meets or exceeds established safety standards.

Approved helmets in the USA and Canada bear a U.S. Department of Transportation (DOT) label.

Approved helmets in Europe, Asia and Oceania bear the ECE 22.05 label. The ECE mark consists of a circle surrounding the letter E, followed by the distinguishing number of the country which has granted approval.

The approval number and serial number will also be displayed on the label.

## Safe Riding Gear

### Eye Protection

Do not depend on eyeglasses or sunglasses for eye protection. Whenever riding a vehicle, always wear shatterproof goggles or use a shatterproof helmet face shield. Your recommends wearing approved Personal Protective Equipment (PPE) bearing markings such as VESC 8, V-8, Z87.1, or CE. Make sure protective eye wear is kept clean.

### Gloves

Wear gloves for comfort and for protection from sun, cold weather and other elements.

### Boots

Wear sturdy footwear. Do not ride a vehicle with bare feet.

### Clothing

Wear long sleeves and long pants to protect arms and legs.



## Safety Warnings

### ! WARNIG

Failure to operate this vehicle properly can result in a collision, loss of control, accident or overturn, which may result in serious injury or death.

Be sure to read all of the following warnings about driving hazards and how to avoid them. These warnings are provided for your child's safety. Be sure to explain to your young driver that the hazards outlined in this section of the owner's manual **MUST** be avoided at all times. See the OPERATION section the owner's manual for proper operating procedures.

### Operating Without Instruction

Operating this vehicle without proper instruction increases the risk of an accident. The operator and the supervising adult must understand how to operate the vehicle properly in different situations and on different types of terrain. Complete the New Operator Driving Procedures outlined on pages 47-48.

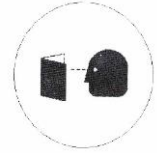

All operators must read and understand the owner's manual and all warning and Instruction labels before operating the vehicle. Never allow a guest to operate this vehicle until the guest has read this manual and all product labels and has completed the New Operator Driving Procedures outlined on pages 47-48.



### Age Restrictions

This vehicle is for recreational use by young operators under adult supervision **ONLY**. Operation is prohibited for anyone age 10 and under. Never operate with a passenger age 10 and under. Make sure any passenger is tall enough to comfortably and safely reach the hand holds and place both feet on the floor.

15

## Safety Warnings

### Rider Height

Some riders may be too tall to ride safely in this vehicle. Do not operate or ride in this vehicle if the clearance between the top of your helmet and the overhead cab frame is less than 2 inches (5 cm).

### Failure to Inspect Before Operating

Failure to inspect and verify that the vehicle is in safe operating condition before operating increases the risk of an accident. Always inspect the vehicle before each use to make sure it's in safe operating condition. Always follow the inspection and maintenance procedures and Schedules described in the owner's manual.

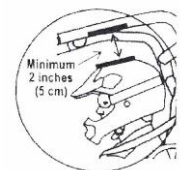

### Accessories

Installing non-approved accessories may seriously affect vehicle handling and stability which could result in loss of control or an accident? Never install accessories not approved by for use on this vehicle.

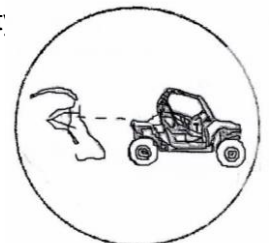

### Protective Apparel

Riding in this vehicle without wearing an approved helmet and protective Eyewear increases the risk of serious injury in the even of an accident. Operator and passenger must always wear an approved helmet that fits properly and eye protection (goggles or face shield).

### Seat Belts

Riding in this vehicle without wearing the seat belt increases the risk of serious injury in the event of an accident or sudden stop. Riders must wear seat belts at all times. Seat belts reduce the severity of injury in



16

## Safety Warnings

In the event of a sudden stop or accident. Always make sure the seat belts are secured for both the operator and passenger before riding.

### Cab Nets/Side Guards

Riding in this vehicle without using the cab nets and side guards increases the risk of serious injury or death in the event of an accident or overturn. Always use the cab nets and side guards while riding in this vehicle. Always keep hands and feet inside the vehicle at all times.

### Using Alcohol or Drugs

Riding in this vehicle after consuming alcohol or drugs could adversely affect operator judgment, reaction time, balance and perception. Never consume alcohol or drugs before or while operating or riding in this vehicle.



### Carrying a Passenger

Never carry a passenger until you have operated this vehicle for at least four hours and Have completed the New Operator Driving Procedures outlined on pages 47-48.



### Carrying Multiple Passengers

Carrying more than one passenger in this vehicle can affect the operator's ability to steer and operate the controls, which increases the risk of loss of control and accident or overturn. Never carry more than one passenger in this vehicle.

## Safety Warnings

### Operating on Pavement

Operating this vehicle on paved surfaces (including sidewalks, paths, parking lots, and driveways) may seriously affect handling and control of the vehicle, and may cause the vehicle to go out of control. This vehicle's tires are designed for off-road only, not for use on pavement.

Avoid operating the vehicle on pavement. If you must operate on a paved surface, travel slowly and do not make sudden turns or stops.

### Operating on Public Roads

Operating this vehicle on public streets, roads or highways could result in a collision with another vehicle. Never operate this vehicle on any public street, road or highway, including dirt and gravel roads. In many areas it's unlawful to operate vehicles of this type on public streets, roads and highways.

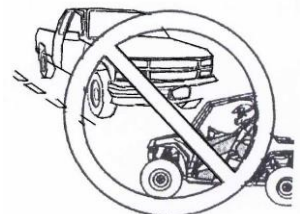

### Operating at Excessive Speeds

Operating this vehicle at excessive speeds increases the operator's risk of losing control. Always operate at a speed that's appropriate for the terrain, the visibility and operating conditions, your skills and your passenger's skills.

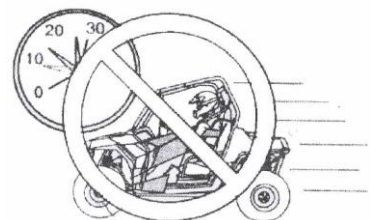

### Turning Improperly

Turning improperly could cause loss of traction, loss of control, accident or overturn. Always follow proper procedures for turning as described in the owner's manual. Never turn abruptly or at sharp angles. Never turn at high speeds. Practice turning at slow speeds before attempting to turn at faster speeds.

### Physical Control of the Vehicle

Removing hands from steering wheel or hand holds or removing feet from the floor while riding increases the risk of loss of control and accident or overturn.

The operator should always keep both hands on the steering wheel during operation. A passenger should always be seated in the passenger seat with both feet on the floor and with both hands securely grasping the hand holds. Always keep hands and feet inside the vehicle at all times.

### Jumps and Stunts

Exhibition driving increases the risk of an accident or overturns. DO NOT do power sides, "donuts", jumps or other driving stunts. Avoid exhibition driving.

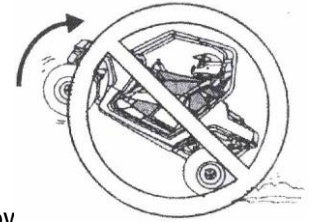

### Driving Downhill Improperly

Driving down a hill improperly could cause loss of control or overturn. Always follow proper procedures for driving down a hill as described in the owner's manual.

- Always drive down a hill with the transmission in forward gear .Never drive down a hill with the transmission in neutral.
- Never operate the vehicle on hills steeper than 15 degrees.
- Always check the terrain carefully before driving down a hill.
- Never travel down a hill at high speed.
- Avoid traveling down a hill at an angle ,which would cause the vehicle to lean sharply to one side. Travel straight downhill.



### Improper Hill Climbing

Improper hill climbing could cause loss of control or overturn. Use extreme caution when operating on hills. Always follow proper procedures for hiss climbing as described in the owner's manual. See page 51.Never operate the vehicle on hill steeper than 15 degrees.

### Stalling While Climbing a Hill

Stalling or rolling backwards while climbing a hill Could cause an overturn. Maintain a steady Speed when climbing a hill.

If you lose all fort/yard speed:

Apply the brakes gradually until the vehicle is fully stopped. Place the transmission in reverse and slowly allow the vehicle to roll straight downhill while applying light brake pressure to Control speed.

### Crossing Hillsides

Driving on a side hill is not recommended. Improper procedure could cause loss of control Or overturn. Avoid crossing the side of any hill Unless absolutely necessary. If crossing a hillside is unavoidable, always follow procedures as Described in the owner's manual. See page 52.

### Operating in Unfamiliar Terrain

Failure to use extra caution when operating on unfamiliar terrain could result in an accident or overturn.

Unfamiliar terrain may contain hidden rocks, bumps, or holes that could cause loss of control or overturn.

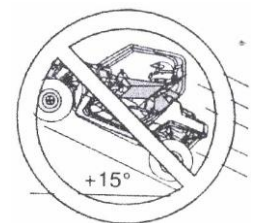

Travel slowly and use extra caution when operating on unfamiliar terrain. Always be alert to changing terrain conditions.

### Operating on Sand or Slippery Terrain

Operating on sand or on excessively, rough, slippery or loose terrain could cause loss of traction, loss of control, accident or overturn. Always use extra caution when operating on sand or on rough, slippery or loose terrain.

Do not operate on excessively rough, slippery or loose terrain.



### Operating Improperly in Reverse

Improperly operating in reverse could result in a collision with an obstacle or person. Always follow proper operating procedures as outlined in this manual. See page 55. Before shifting into reverse gear, always check for obstacles or people behind the vehicle. When it's safe to proceed, back slowly.

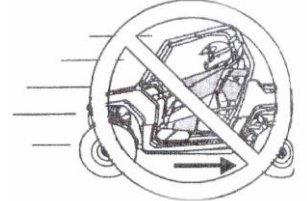

### Improper Tires and Maintenance

Installing non-approved tires may seriously affect vehicle handling and stability, which could result in loss of control or an accident. Never install tires not approved for use on this vehicle. Operating this vehicle with improper or uneven tire pressure could cause loss of control, accident or overturn. Always maintain proper tire pressure as described in the owner's manual and on safety labels.



## Safety Warning

### Operating Over Obstacles

Improperly operating over obstacles could cause loss of control or overturn. Before operating in a new area, check for obstacles. Never attempt to operate over large obstacles such as rocks or fallen trees. Always follow the proper procedures outlined in this manual when operating over obstacles.

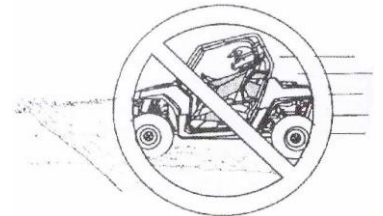

### Skidding or Sliding

Skidding or sliding can cause loss of control or overturn (if tires regain unexpectedly). Always follow proper procedures for operating on slippery surfaces as described in the owner's manual.

When operating on slippery surfaces such as ice or loose gravel, reduce speed and use extra caution to reduce the chance of skidding or sliding.

Do not operate on excessively slippery surfaces.

### Operating Through Water

Operating through deep or fast-flowing water can cause loss of traction, loss of control, overturn or accident. Never operate in fast-flowing water or in water that exceeds the floor level. Always follow proper procedures for operating in water as described in the owner's manual. Wet brakes may have reduced stopping ability. After leaving water, test the brakes. Apply them lightly several times while driving slowly. The friction will help dry out the pads.



## Safety Warnings

### Overloading the Vehicle

Overloading the vehicle or carrying/towing loads may cause changes in stability and handling, which could cause loss of control or an accident.

- Never tow objects or carry loads with this vehicle.
- Never exceed the maximum weight capacity for this vehicle.

### Operating a Damaged Vehicle

Operating a damaged vehicle can result in an accident with serious injury or death. After any overturn or accident, have a qualified service dealer inspect the entire vehicle for possible damage, including (but not limited to) brakes, throttle and steering systems.

### Operating on Frozen Bodies of Water

Operating on frozen bodies of water can result in the vehicle and/or riders falling through the ice. Never operate this vehicle on a frozen body of water.

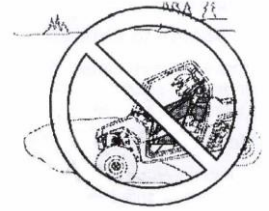

### Handling Gasoline

Gasoline is highly flammable and is explosive under certain conditions. Always exercise extreme caution whenever handling gasoline.

- Never allow a child to refuel or handle gasoline.
- Always stop the engine when refueling.

- Always refuel outdoors or in a well ventilated area.
- Do not smoke or allow open flames or sparks in or near the refueling area or where gasoline is stored.
- Never refuel while a person is in the vehicle.
- Do not over fill the tank. Do not fill the tank neck.
- If gasoline spills on your skin or clothing, immediately wash it off with soap and water and change clothing.
- Turn the fuel valve off whenever the vehicle is stored or parked.

### Exposure to Exhaust

Engine exhaust fumes are poisonous and can cause loss of consciousness or death in short time. Never start the engine or let it run in an enclosed area. Operate this vehicle only outdoors or in well-ventilated areas.

### Hot Exhaust Systems

Exhaust system components are very hot during and after use of the vehicle. Hot components can cause burns and fire. Do not touch hot exhaust system components. Always keep combustible materials away from the exhaust system.

Use caution when traveling through tall grass, especially dry grass. Always inspect the underside of the vehicle and areas near the exhaust system after driving through tall grass, weeds, brush and other tall ground cover. Promptly remove any grass or debris clinging to the vehicle.



### Unauthorized Use of the Vehicle

Leaving the keys in the ignition can lead to unauthorized use of the vehicle, which could result in an accident or overturn. Always remove the ignition key when the vehicle is not in use.

### Safety Labels and Locations

Warning labels have been placed on the vehicle for your protection.

Read and follow the instructions on each label carefully. If any of the labels shown in this manual differ from the labels on your vehicle, always read and follow the instructions of the labels on the vehicle.

If an informational or graphic label becomes illegible or comes off, contact your dealer to purchase a replacement. Replacement safety labels are provided at no charge. The part number is printed on the label.

### Safety Labels and Locations

#### Rear warning label

#### WARNING

Improper vehicle use can result in SEVERE INJURY or DEATH.

NEVER ALLOW TO BE OPERATED:

- Without all occupants first viewing and understanding safety video, and warning labels.
- With more than one passenger.
- On hills steeper than 15 degrees  $\angle$  15°.
- On paved surfaces-pavement may seriously affect handling and control.
- With non approved accessories – they may seriously affect stability.
- At speeds that are too fast for the operator’s skills, the conditions and/or the terrain.



ALWAYS REQUIRE OPERATOR AND PASSENGER TO:

- Wear seat belts, grab hand holds (passenger) and plant feet firmly on the floor.
- Secure cab nets.
- Keep hands and feet inside vehicle.
- Avoid quick turns of the steering wheel and driving stunts such as jumps, donuts or power slides.
- Reduce speed and use extra caution when carrying a passenger.
- Watch for branches or other hazards that could enter vehicle.

#### WARNING

Operation of this vehicle by children age 16 and under increases the risk of severe injury or death.

NEVER PERMIT CHILDREN AGE 16 AND UNDER TO OPERATE OR RIDE IN THIS VEHICLE.

#### WARNING

VEHICLE OVERTURN COULD CAUSE SEVERE INJURY OR DEATH. THE CAB FRAME IS NOT DESIGNED OR INTENDED TO PROVIDE RELIEVER PROTECTION.

#### TIRE PRESSURE IN PSI (KPA):

Front: 24psi (170kpa)

Rear: 24psi (170kpa)

#### MAXIMUM WEIGHT CAPACITY 330lbs.(150kg)

INCLUDES WEIGHT OF OPERATOR, PASSENGER AND ACCESSORIES.LOCATE AND READ OWNER’S MANUAL. FOLLOW ALL INSTRUCTIONS AND WARNINGS.IF OWNER’S MANUAL IS MISSING,

CONTACT A DEALER FOR A REPLACEMENT.

# FEATURES AND CONTROLS

## Component Locations

Your vehicle is equipped with cab nets and side guards in both sides of the vehicle. Cab nets and side guards must be used by both operator and passenger at all times promptly replace worn or damaged cab nets with new cab nets available from your authorized dealer. The vehicle illustrated below is shown without cab nets only to allow component identification. Always use the cab nets and side guards.

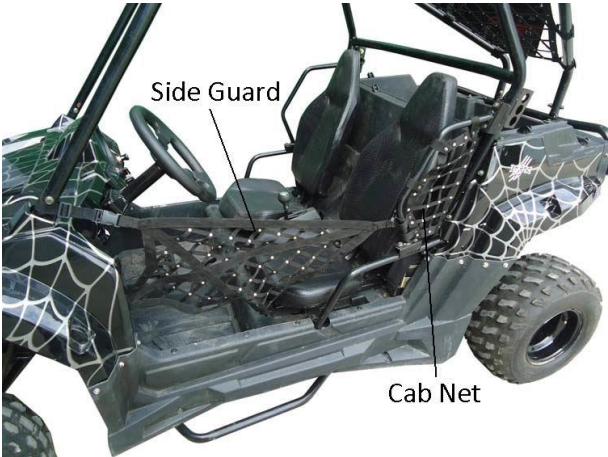
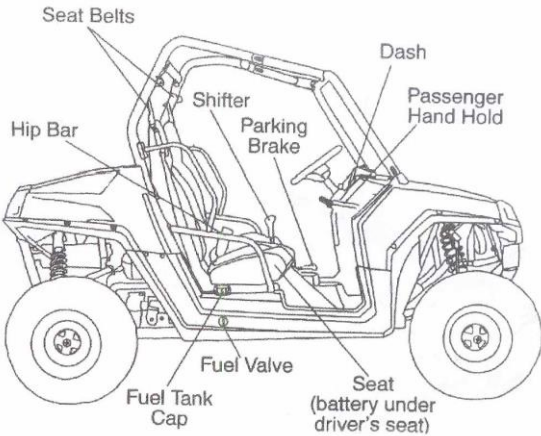

## Component Locations

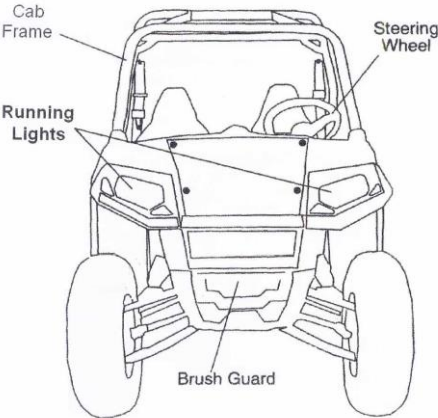

## Seats

### Driver's Seat Adjustment

1. Lift the seat latch lever located under the right front edge of the driver's seat.
2. While holding the lever upward, slide the seat forward, or rearward to the desired position, then release the lever.
3. Slide the seat forward and rearward to ensure the latch is engage. Before operating the vehicle, always make sure both seats are securely installed.



### Seat Removal

1. To remove the driver's seat lift the seat latch lever.
2. While holding the lever upward slide the seat completely forward to remove it from the seat mounting rails.
3. Before operating the vehicle, always make sure the driver's seat is installed and securely latched.
4. To remove the passenger seat, remove the two bolts located at the front of the seat mounting rails. Slide the seat forward to remove it from the vehicle. Always reinstall the passenger seat before operating the vehicle. After reinstalling the seat and bolts, the nuts to 10 ft. lbs.(13.5Nm).

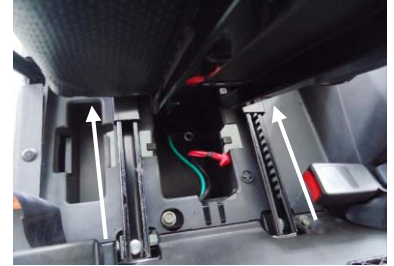

## Steering Wheel

The steering Wheel can be adjusted upward or downward for rider preference.

1. Loosen the steering wheel adjustment bolt.
2. Mow the steering wheel upward or downward to the desired position.
3. Tighten the bolt 10 ft. lbs.(13.5Nm)

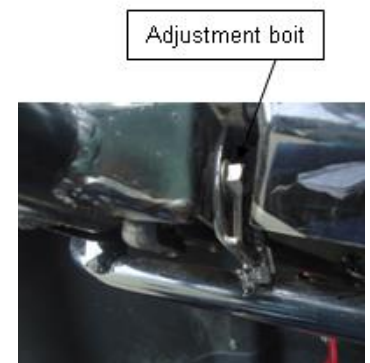

## Passenger Hand Hold

Always adjust the hand hold to a comfortable position for your passenger before operating. Make sure the adjustment pin and retainer are securely installed after making adjustments.

1. Remove the retainer from the end of the adjustment pin. Remove the pin from the post.
2. Slide the post inward or outward to the desired position.
3. Reinstall the pin through the mounting bracket hole, trough both post adjustment holes, and through the remaining bracket hole.
4. Reinstall the retainer to the pin.

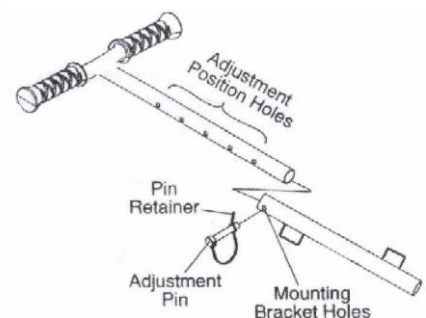



## Seat Belts

This vehicle is equipped with three-point lap and diagonal seat belts for the operator and passenger. Always make sure the seat belts are secured for both the operator and passenger before riding.

To wear the seat belt properly, follow this procedure:

1. Pull the seat belt latch downward and across your chest toward the buckle at the inner edge of the seat. The belt should fit snugly across your hips and diagonally across your chest. Make sure the belt is not twisted.

Tip: The position of the shoulder strap can be adjusted to the height of the operator. Have an adult relocate the mounting bolt to a different position, making sure the nut and bolt are tightened securely.

2. Push the latch plate into the buckle until it clicks.
3. Release the strap, it will self-tighten,
4. Press the red release latch on the buckle to release the seat belt.

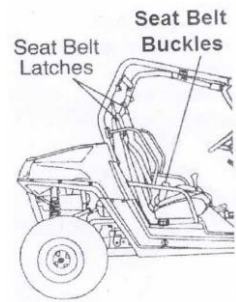

Nut and bolt

## Seat Belts

### Seat Belt Inspection

Inspect all belts for before each of the vehicle.

1. Push the latch plate into the buckle until it clicks. The latch plate must slide smoothly into the buckle. A click indicates that it's securely latched.
2. Push the red release latch in the middle of the buckle to make sure it releases freely.
3. Pull each seat belt completely out and inspect the full length for any damage, including cuts, wear, fraying or stiffness. If and damage is found, or if the seat belt does not does not operate properly, have the seat belt system checked and/or replaced by an authorized dealer.
4. To clean dirt or debris from the seat belts, sponge the straps with mild soap and water. Do not use bleach, dye or household detergents

## Cab Nets/Side Guards

Riding in this vehicle without using the cab nets and side guards increases the risk of serious injury or death in the event of an accident or overturn.

Cab nets and side guards must be used by both operator and passenger at all times. Make sure all latches are secure before operating the vehicle.

Always inspect cab nets for tightness, wear and damage

before each use of the vehicle. Use the strap adjusters to tighten any loose straps. Promptly replace worn or damaged cab nets with new cab nets, available from your authorized Yours dealer.

### Storage Box

The storage box is attached to the cab frame behind the seats. Use the storage box to carry lightweight items such as water bottles or apparel.

Do not carry heavy items in the storage box.



### Fuel Cap



Never allow a child to refuel or handle gasoline.

The fuel tank filler cap is located on the right-hand side of the Vehicle near the passenger seat. When refueling always use either leaded or unleaded gasoline with a minimum pump octane number of 87 R+M/2 octane. Do not use fuel with ethanol content greater than 10 percent, such as E-85 fuel.

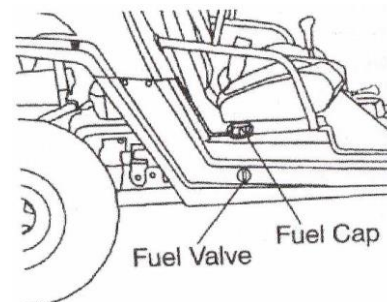

### Fuel Valve

The fuel valve is located on the right side of the vehicle near the fuel cap. It has three settings.

**OFF:** For vehicle storage and when transporting.

**ON:** For normal operation.

**RES:** For reserve supply if main supply is exhausted.

The reserve setting allows operation for approximately 7-10 miles (11-16 km). Always refill the gas tank as soon as possible after using the Main supply, Always return the valve to the ON position after refueling.

### Ignition Switch

The ignition switch is a three-operated switch. Use the ignition switch to start the engine. See page 45 for starting procedures.

The key can be removed from the switch when it is in the OFF position.

OFF	The engine is off. Electrical circuits are off, except accessory 12v.
ON	Electrical circuits are on. Electrical equipment can be used.

START	Turn the key to the START position to engage the electric starter. The key returns to the ON position when released.
-------	--



Ignition switch

35

### Gear Selector

- F: Forward
- N: Neutral
- R: Reverse

The gear selector is located between the seats. To change gears, stop the Vehicle, and with the engine idling, move the lever to the desired gear. Do not attempt to shift gears with engine speed above idle or while the vehicle is moving.

**Tip:** Maintaining shift linkage adjustment is important to assure proper transmission function. See your dealer if you experience any shifting problems.

**NOTICE:** Do not attempt to shift the transmission while the vehicle is moving or damage to the transmission could result. Always shift when the vehicle is stationary and the engine is at idle.

### Parking Brake

1. Apply the brakes.
2. When the vehicle is fully stopped, pull the parking brake lever rearward as far as possible to set the parking brake.
3. Stop the engine.
4. To release the parking brake apply the brakes and push the lever toward the passenger seat and forward.

**Tip:** Always set the parking brake whenever the vehicle is left unattended.

**!** Operating the vehicle while the parking brake is engaged could cause an accident resulting in serious injury or death. It could also result in driveline or engine or engine damage. Always be sure to disengage the parking brake before operating the vehicle.

Gear selector



36

### Brake Pedal

Depress the brake pedal to slow or stop the vehicle. Apply the brakes while starting the engine.

### Throttle Pedal

Push the pedal down to increase engine speed when released. Always check for throttle pedal adjustment procedures.



Brake pedal

Throttle pedal

returns the pedal to the rest position fully before starting the engine.

## Speed Control System

The speed of this vehicle is restricted to less than 25MPH (40km/h) at manufacture; the speed limiting device may be adjusted by supervising when they determine that their child is capable of handling additional speed. The unrestricted top speed for this model is approximately 35MPH (56km/h).

The adjustable throttle limiting screw is located behind the throttle pedal.

Use the following procedure to control how far the throttle opens.

1. Loosen the jam nut.
2. Turn the screw outward to reduce speed. Turn the screw inward to increase speed,
3. Tighten the jam nut after adjusting.

## 38 OPERATION

### **!WARNING**

Failure to operate the vehicle properly can result in a collision, loss of control. Accident or overturn, which may result in serious injury or death. Read and understand all safety warnings outlined in the safety section of this owner's manual.

### **Vehicle Break-in Period**

The break-in period for your new vehicle is defined as the first ten hours of operation, or the time it takes to use the first two full tanks of gasoline.

No single action on your part is as important as a proper break-in period.

Careful treatment of a new engine and drive components will more efficient performance and longer life for these components. Perform the following procedures carefully.

### **NOTICE:**

Excessive heat build-up during the first three hours of operation will damage close-fitted engine parts and drive components. Do not operate at full throttle or high speeds during the first three hours of use. Mixing brands or using non-recommended oil may cause serious engine damage. Always use the recommended oil. Never substitute or mix oil brands.

### Engine and Drive train Break-in

1. Fill the tank with gasoline. Always exercise extreme caution. Whenever handling gasoline. Never allow a child to handle gasoline.
2. Choke the oil level. See page 63. Add the recommended oil, as needed to maintain the oil level in the safe operating range.
3. Complete the New Operator Driving Procedures outlined on pages 47-48.
4. Avoid aggressive use of the brakes. See Brake System Break-in below.
5. Vary throttle positions. Do not operate at sustained idle.
6. Perform regular checks on fluid levels, controls and areas outlined on the daily pre-ride inspection checklist .See page 43.
7. Change the engine oil at 10 hours or one month.
8. Adjust and lubricate the drive chain at 10 hours or one month.

### Brake System Break-in

Apply only moderate braking force for the first 50 stops. Aggressive or overly forceful braking when the brake system is new could damage brake pads and rotors.

### CVT Break-in (Clutches/Belt)

A proper break-in of the clutches and drive belt will ensure a longer life and better performance. Break in the clutches and belt by operating at slower speeds during the break-in period as recommended. Avoid aggressive acceleration and high speed operation during the break-in period.

### Pre-Ride Inspection

Failure to inspect and verify that the vehicle is in safe operating condition before operating increases the risk of an accident. Always inspect the vehicle before each use to make sure it's in safe operating condition.

Item	Remarks	Page
Brake system/pedal travel	Ensure proper operation	39 /77
Brake fluid	Ensure proper level	78
Front suspension	Inspect, lubricate if necessary	63
Rear suspension	Inspect, lubricate if necessary	63
Steering	Ensure free operation	79
Tires	Inspect condition and pressure	28/81
Wheels/fasteners	Inspect, ensure fastener tightness	82
Frame nuts, bolts, fasteners	Inspect, ensure tightness	-
Fuel and oil	Ensure proper levels	36/64
Grass and debris	Remove, grass and debris from the vehicle, especially on the underside and near the exhaust system	-
Throttle	Ensure proper operation	74
Indicator lights/switches	Ensure proper operation	-
Air filter, pre-filter	Inspect, clean or replace	72
Daytime running lights	Ensure proper operation	83
Brake light	Ensure proper operation	-
Seat Latches	Move the seats forward and rearward to ensure correct installation	31
Seat Belts	Check length of belt for damage, check latches for proper operation	33
Cab Nets	Check for wear or damage, ensure proper installation	35

## Safe Operation practices

1. Complete the New Operator Driving Procedures outlined on pages 47-48.
2. Do not ride at night or when visibility is poor (rain, fog, dusk). Your vehicle does not have lights that are designed for driving in these conditions.
3. Never tow objects or carry loads with this vehicle.
4. Engine exhaust fumes are poisonous. Never start the engine or let it run in an enclosed area. Never allow a child to handle gasoline.
5. Never install accessories not approved by the manufacturer for use on this vehicle.
6. Ride this vehicle only in areas permitted by a supervising adult. Never operate the vehicle on pavement or on any public street, road or highway, including dirt and gravel roads.
7. Drive in a manner appropriate for your skills and operating conditions. Never operate at excessive speeds. DO NOT attempt to do power slides, "donuts" jumps or other driving stunts. Keep both hands on the steering wheel at all times.
8. Never consume alcohol or drugs before or while operating this vehicle.
9. Always use the size and type of tires specified for your vehicle. Always maintain proper tire pressure.
10. Never operate a damaged vehicle. After any overturn or accident, have a qualified service dealer inspect the entire machine for possible damage.
11. Never operate the vehicle on a frozen body of water.
12. Do not touch hot exhaust system components. Always keep combustible materials away from the exhaust system.
13. Always remove the ignition key when the vehicle is not in use to prevent unauthorized use.

## Starting the Engine

1. Turn the fuel valve on.
2. Sit in the driver's seat and fasten the seat belt.
3. Secure the cab nets.
4. Place the transmission in neutral. Set the parking brake.
5. Apply the brakes.
6. Do not press the throttle pedal while starting the engine.
7. Turn the ignition key past the ON/RUN position to START. Engage the starter for a maximum of five seconds. Release the key when the engine starts.

### NOTICE:

Operating the vehicle immediately after starting could cause engine damage. Allow the engine to warm up for several minutes before operating the vehicle.

8. If the engine does not start within five seconds, return the ignition switch to the OFF position and wait five seconds. Repeat steps 7 and 8 until the engine starts. If your vehicle has Hand-choke:

Tip: If warm engine has cooled to a point where it does not readily start, intermittent use of the choke (pulled half way out) may be necessary. If the engine is over-choked when warm, depress the throttle lever fully while cranking to aid in starting. Release the throttle lever immediately after the engine starts. If the engine does not start and all conditions are favorable, change the spark plug and try again.

9. Vary the engine RPM slightly with the throttle to aid in warm-up until the engine idles smoothly.
10. Release the parking brake before driving.

### Stopping the Engine

1. Release the throttle pedal completely and brake to a complete stop.
2. Place the transmission in neutral.
3. Set the parking brake.
4. Stop the engine.
5. Turn the fuel valve off.

### Braking

1. Release the throttle pedal completely. (When the throttle pedal is released completely and engine speed slows to near idle, the vehicle has engine braking.)
2. Press on the brake pedal evenly and firmly. Practice starting and stopping (using the brakes) until you're familiar with the controls.

### Parking the Vehicle

1. Stop the vehicle on a level surface. When parking inside a garage or other structure, be sure that the structure is well ventilated and that the vehicle is not close to any source of flame or sparks, including any appliance with pilot lights.
2. Place the transmission in neutral.
3. Set the parking brake.
4. Stop the engine.
5. Turn the fuel valve off.
6. Remove the ignition key to prevent unauthorized use.

### New Operator Driving Procedures

1. Read and understand the owner's manual and all warning and instruction labels before operating this vehicle.
2. Watch the instructional video with the supervising adult.
3. Review the section of this owner's manual about starting the engine stopping the engine, braking and parking(pages 45-46).
4. Perform the Pre-ride inspection(page 43)
5. Wear appropriate riding gear, including an approved helmet and protection (goggles or face shield).
6. Select a level open area to practice driving. Make sure you have adult supervision and permission to drive in this area.
7. Sit in the driver's seat and fasten the seat belt.
8. Do not operate or ride in this vehicle if the clearance between the top of your helmet and the overhead cab frame is less than 2 inches(5 cm).

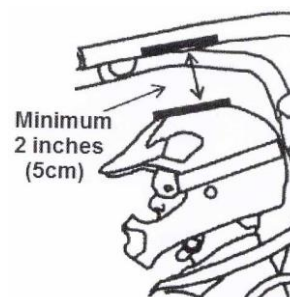
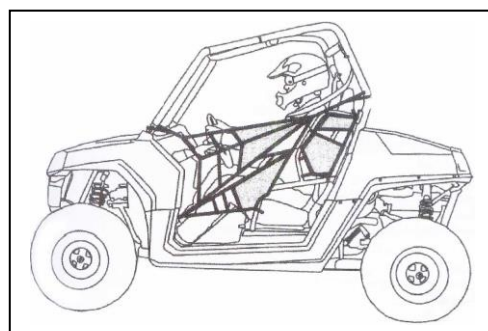

(continued on next page)

### New Operator Driving Procedures

9. Do not carry a passenger until you have at least four hours of driving experience with this vehicle. See page 49.
10. Make sure all cab nets and side guards are properly secured.
11. Set the transmission in neutral.
12. Place the transmission in neutral.
13. Start the engine.
14. Apply the brakes and shift into gear.
15. Release the parking brake.
16. Check your surroundings. Make sure the area is clear of people and obstacles.
17. Keeping both hands on the steering wheel, slowly release the brakes and press the throttle with your right foot to begin driving.
18. Drive slowly at first. Practice starting, stopping, turning, using the throttle and brakes and driving in reverse. Learn how the vehicle handles when making both left and right turns at a slow speed.
19. In case speed only after mastering all maneuvers at slow speed.
20. After you become skilled at making turns and begin to operate at faster speeds, follow these precautions:
  - Avoid sharp turns. Make turns gradually.
  - Never turn while applying heavy throttle.
  - Never turn the steering heavy throttle.
  - Operate at speeds appropriate for your skills, the conditions and the terrain.
  - DO NOT attempt to do power slides, "donuts", jumps or other driving stunts.

### Driving with a passenger

1. Complete the New operator driving procedures outlined on pages 47-48.
2. Perform the pre-ride inspection. See page 43.
3. Do not carry a passenger until hours or driving experience with this vehicle.
4. Never operate with a passenger age 16 and under. Make sure the passenger is tall enough to comfortably and safely sit in the passenger seat with the seat belt secured, put both feet on the floor and grasp the hand holds.
5. Make sure the passenger has at least 2 inches (5cm) of clearance between his helmet and the top of the cab frame.
6. Never carry more than one passenger in this vehicle.
7. Never allow a passenger to ride on the back of the vehicle. Allow a passenger to ride only in the passenger seat.
8. Make sure the passenger is wearing appropriate riding gear, including an approved helmet and eye protection. See page 15.
9. Make sure the passenger secures the seat belt.
10. Tell your passenger to always keep hands and feet inside the vehicle at all times.
11. Make sure all cab nets and side guards are properly secured.
12. Drive slowly. Vehicle handling may change with a passenger on board. always travel at a speed appropriate for your skills, your passenger's skills, and operating conditions. Avoid unexpected or aggressive maneuvers that could cause discomfort or injury to a passenger.
13. Always follow all operating guidelines as outlined on safety label and in this manual.





## Driving on Slippery Surfaces

When driving on slippery surfaces such as wet trails, loose gravel, sand or ice, be alert for the possibility of skidding and sliding,



Skidding or sliding can cause loss of control or overturn, especially if tires regain traction unexpectedly. When operating on slippery surfaces such as ice or loose gravel, slow down and use extra caution to help prevent skidding or sliding. Always use extra caution when operating on sand or on rough, slippery or loose terrain. Do not operate on excessively rough, slippery or loose terrain.

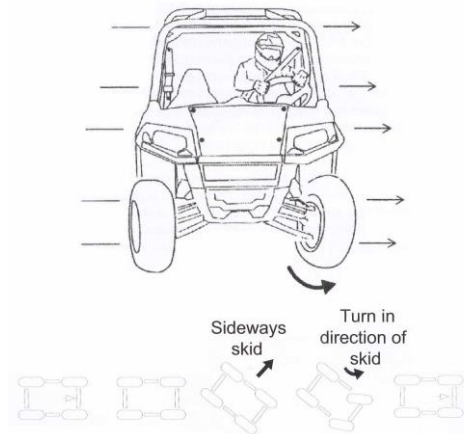

Follow these precautions when driving in slippery conditions:

1. Slow down before entering slippery areas.
2. Be alert, watch the path ahead and avoid quick turns, which can cause skids.
3. Correct a skid by turning the steering wheel in the direction of the Skid. Never apply the brakes during skid.

## Driving Uphill

Whenever traveling uphill, follow these precautions:

1. Always check the terrain carefully before ascending a hill
2. Avoid steep hills (15° maximum).
3. Drive straight uphill.
4. Never climb hills with excessively slippery or loose surfaces.
5. Drive at a steady rate of speed. Never press the throttle suddenly
6. Avoid unnecessary changes in speed or direction.
7. Never go over the crest of a hill at a high speed. An obstacle, a sharp drop, or another vehicle or person could be on the other side of hill.
8. If the vehicle stalls while climbing a hill, apply the brakes. Place transmission in reverse and slowly allow the vehicle to roll straight downhill while applying the brakes lightly to control speed.

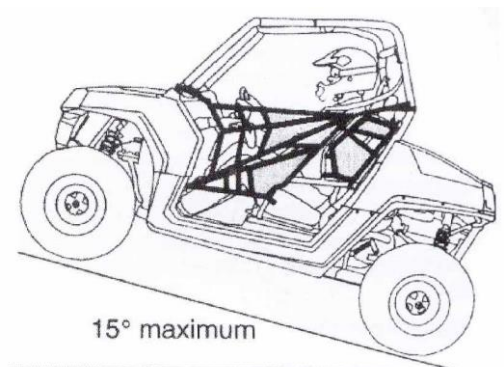

### Driving on a Side hill (Side hilling)

Driving on a side hill is not recommended. Driving on a side hill improperly cause loss of control or overturn. If crossing a hill is unavoidable, follow these precautions:

1. Drive slowly and use extreme caution.
2. If the vehicle begins to overturn, or if it feels as if it may overturn, immediately turn downhill.
3. Avoid obstacles and changes in terrain that may lower or raise one side the vehicle or cause the vehicle to slide.
4. If the vehicle begins to slide downhill, immediately turn downhill to stop the slide.

### Driving Downhill

Whenever driving down a hill, follow these precautions:

1. Avoid steep hills (15° maximum).
2. Slow down. Never travel down a hill at high speed.
3. Always check the terrain carefully before driving down a hill.
4. Always drive down a hill with the transmission in forward gear. Never "coast" or drive down a hill with the transmission in neutral.
5. Avoid driving down a hill at an angle, which would cause the vehicle lean sharply to one side. Always drive straight downhill.
6. Apply the brakes lightly to keep speed slow.

### Driving Through Water

Your vehicle can drive through shallow water. Make sure the water is no deeper than the floor of the vehicle. Follow these precautions when driving through water:

1. Check water depth. Never drive through water that is deeper than the floor level.
2. After driving through water, test the brakes. Apply them lightly several times while driving slowly. The friction will help dry out the pads.

#### NOTICE:

Major engine damage can result if the vehicle is not thoroughly inspected after operation in water. Perform the services outlined in maintenance chart. See page 58. Give special attention to engine transmission oil and all grease fittings.

If your vehicle is operated in water deeper than the floor level, take it to your dealer for service before starting the engine. If it's impossible to bring the vehicle to your dealer starting the engine, perform the service outlined on page 84, and take the vehicle to your dealer as soon as possible.

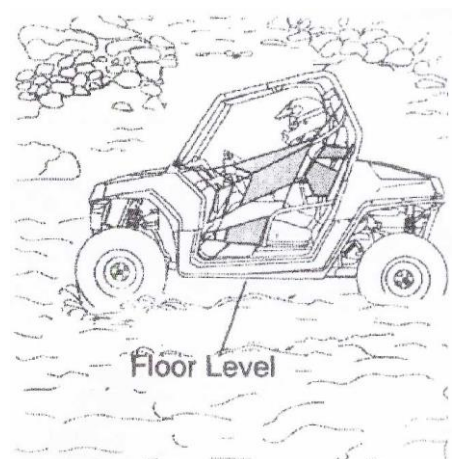

## Driving Over Obstacles

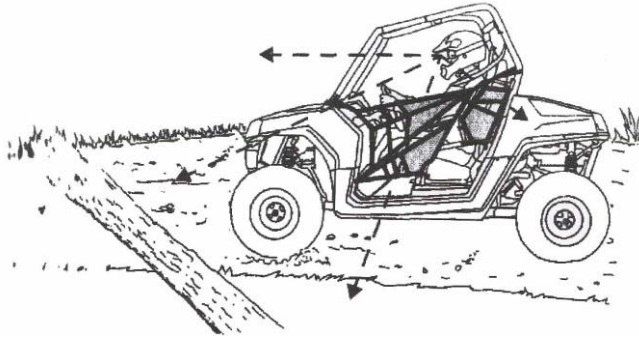

Follow these precautions when driving over obstacles

1. Always check for obstacles before driving in a new area.
2. Look ahead and watch the terrain. Always be alert for hazards such as logs, rocks and low hanging branches.
3. Drive slowly and use extra caution when driving on unfamiliar terrain. Obstacles are not always clearly visible.
4. Do not drive over large obstacles such as rocks and fallen trees. If it's unavoidable, use extreme caution and drive slowly.
5. Always have a passenger dismount and move away from the vehicle before driving over an obstacle that could cause an overturn.

## Driving Reverse

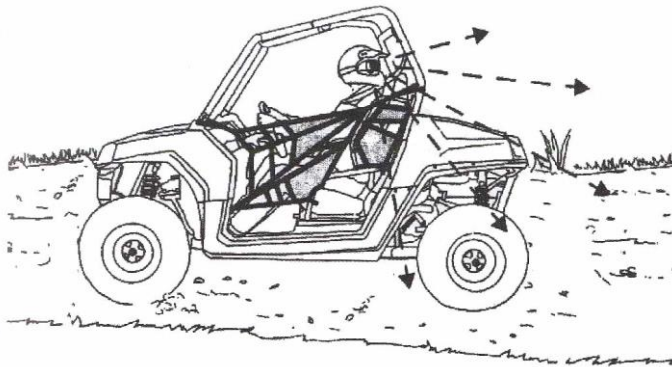

Follow these precautions when driving in reverse:

1. Always check for obstacles or people behind the vehicle.
2. Apply the throttle lightly. Never apply the throttle suddenly.
3. Back slowly.
4. Apply the brakes lightly for stopping.
5. Avoid making sharp turns.

## Parking on an Incline

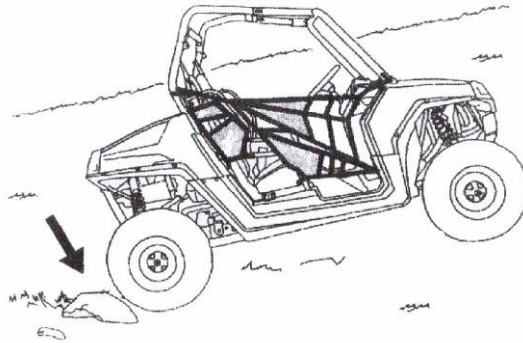

A rolling vehicle can result serious injury. Avoid parking on an Incline. If parking on an incline is unavoidable, follow these precautions:

1. Place the transmission in neutral.
2. Set the parking brake.
3. Stop the engine.
4. Turn the fuel valve off.
5. Always block the rear wheels on the downhill side.

## EMISSION CONTROL SYSTEMS

### Noise Emission Control System

Do not modify the engine, intake or exhaust components, doing may affect compliance with U.S.A. EPA noise control requirement, CFR 205 and local noise level requirements.

### Operation on Public Lands in the U.S.A.

Your vehicle has a spark arrestor that was tested and qualified to be in accordance with the USFS standard 5100-1c. Federal law requires that this spark arrestor be installed and functional when the vehicle is operated on public lands.

Operation of off-road vehicles on public lands in the U. S. A. is regulated by 43 CFR 420. Violations is subject to monetary penalties.

### Crankcase Emission Control System

This engine is equipped with a closed crankcase system. Blow-by gases are forced back to the combustion chamber by the intake system. All exhaust gases exit through the exhaust system.

### Exhaust Emission Control System

The emissions from the exhaust of this vehicle are controlled by engine design, including factory-set fuel delivery and ignition. The engine and related components must be maintained at specifications to achieve optimal performance.

Engine idle speed is the only adjustment recommends that you perform. Any other adjustments should be performed by an authorized dealer.

The emissions label is located on the frame behind the right front wheel.

### Electromagnetic Interference

This spark ignition system complies with Canadian ICES-002.

## MAINTENANCE

### Periodic Maintenance Chart

Careful periodic maintenance will help keep your vehicle in the safest, most reliable condition. Inspection, adjustment and lubrication of important components are explained in the periodic maintenance chart.

Inspect, clean, lubricate, adjust and replace parts as necessary. When inspection reveals the need for replacement parts, use genuine parts available from your dealer.

Record maintenance and service in the Maintenance Log beginning on page 111.

Service and adjustments are important for proper vehicle operation. If you're not familiar with safe service and adjustment procedures, have a qualified dealer perform these operations.

Maintenance intervals in the following chart are based upon average riding conditions and an average vehicle speed approximately ten (10) miles per hour. Vehicles subjected to severe use must be inspected and serviced more frequently.

### Severe Use Definition

- Frequent immersion in mud, water or sand
- Racing or race-style high RPM use
- Prolonged low speed operation
- Extended idle
- Short trip cold weather operation

Pay special attention to the oil level. A rise in oil level during cold weather can indicate contaminants collecting in the oil sump or crankcase. Change oil immediately if the oil level begins to rise. Monitor the oil level, and if it continues to rise, discontinue use and determine the cause see your dealer.

### ! WARNING

Improperly performing the procedures marked with a ■ could result in component failure and lead to serious injury or death. Have an authorized your dealer perform these services.

### Maintenance Chart Key

- ▲ Perform these operations more often for vehicles subjected to severe use.
- E Emission-related service (Failure to conduct this maintenance will not void the emissions warranty but may affect emissions.)
- Have an authorized sealer perform these services.

### Periodic Maintenance Chart

Perform all services at whichever maintenance interval is reached first.

Item	Maintenance Interval (whichever comes first)			Remarks
	Hours	Calendar	Miles(Km)	
■ Steering	-	Daily	-	Check each day before driving the vehicle. Make adjustments as needed. See the Pre-Ride Checklist on page 43.
▲ Front suspension	-	Daily	-	
▲ Rear suspension	-	Daily	-	
Tires	-	Daily	-	
▲ Brake pedal level	-	Daily	-	
▲ Brake pedal travel	-	Daily	-	
Brake system	-	Daily	-	
Wheels/fasteners	-	Daily	-	
Frame fasteners	-	Daily	-	
▲ Engine oil level	-	Daily	-	
▲ E Air filter, pre-filter	-	Daily	-	Inspect; clean often ;replace as needed
Daytime running lights/taillight	-	Daily	-	Check operation
Drive chain CVT housing (if equipped )	- -	Daily Weekly	- -	Inspect daily; adjust and lubricate if needed Drain water as needed, check often if driving wet conditions
▲ E Air filter, main element	-	Weekly	-	Inspect; replace as needed
▲ ■ Brake pad wear	10	Monthly	100(160)	Inspect periodically
■ Idle speed	10	Monthly	100(160)	Check; adjust as needed

### Periodic Maintenance Chart

Item	Maintenance Interval (whichever comes first)			Remarks
	Hours	Calendar	Miles(Km)	
▲ E Choke	10	Monthly	100(160)	Check for proper operation; see dealer for adjustments
▲ Engine oil change (break-in)	10	1M	-	Perform a break-in oil change at one month
Drive chain(break-in)	10	1M	-	Adjust and lubricate
Battery	25	Monthly	250(400)	Check terminals; clean; test
▲ Main gear case oil	25	Monthly	25(400)	Inspect level; change yearly
▲ E Engine breather	25	Monthly	150(250)	Inspect; replace if necessary
▲ Engine oil change	30	6M	300(480)	Perform a break-in oil change at one month
▲ General lubrication	50	3M	500(800)	Lubricate all fittings. pivots. cables, etc.
■ E Throttle cable/ ETC switch	50	6M	300(480)	Inspect; adjust; lubricate; replace if necessary
Carburetor float	50	6M	500(800)	Drain bowl periodically and prior to storage
■ E Choke cable	50	6M	500(800)	Inspect; adjust; lubricate; replace if necessary
E Carburetor air intake ducts/flange	50	6M	500(800)	Inspect duct for proper sealing/air leaks
Shift Linkage	50	6M	500(800)	Inspect, lubricate. adjust
■ Steering	50	6M	500(800)	Lubricate

▲	Front Suspension	50	6M	500(800)	Lubricate
▲	Rear Suspension	50	6M	500(800)	Lubricate

**Periodic Maintenance Chart**

Item		Maintenance Interval (whichever comes first)			Remarks
		Hours	Calendar	Miles(Km)	
■	E Fuel system/filter	100	12M	600(1000)	Check for leaks at tank cap, lines, fuel valve, filter, pump carburetor; replace lines every two years
▲	E Spark plug	100	12M	1000(1600)	Inspect
▲	Engine mounts	100	12M	1000(1600)	Inspect
	Exhaust muffler/pipe	100	12M	1000(1600)	Inspect
■	Ignition timing	100	12M	1000(1600)	Inspect
▲	Wiring	100	12M	1000(1600)	Inspect for wear, routing, security; apply dielectric grease to connectors subjected to water, mud. etc.
■	Clutches (drive and driven)	100	12M	1000(1600)	Inspect; clean; replace worn parts
	Drive belt	100	12M	1000(1600)	Inspect; replace as needed
■	Front wheel bearings	100	12M	1000(1600)	Inspect; replace as needed
■	Brake fluid	200	24M	2000(3200)	Change every two years
	Spark arrestor	300	36M	3000(4800)	Clean out
	Idle speed	-			Adjust as needed
■	Toe adjustment	-			Inspect periodically; adjust when parts are replaced

▲ Perform these procedures more often for vehicles subjected to severe use.

E Emission-Related Service

■ Have an authorized Yours dealer perform these services.

**Lubrication Recommendations**

Check and lubricate all components at the intervals outlined in the Periodic Maintenance Chart beginning on page 58, or more often under severe use, such as wet or dusty conditions. Items not listed in the chart should be lubricated at the general lubrication interval.

Item	Lube	Method
Engine Oil	Yours Synthetic Youth Oil or Synthetic SAE40	See page 64
Brake Fluid	DOT 4	See page 78
Transmission Oil(Main Gear case)	Premium AGL Synthetic Gear case Lube	See page 66
Drive Chain	Yours Chain Lube or SAE 80/90	See page 67
A-Arm Pivots	Yours All Season Premium Grease or grease conforming to NLGL No.2	Grease at general Lubrication interval, also after washing vehicle or driving in water.
▲ Steering Arm Pivots		

▲ Perform these procedures more often for vehicles subjected to severe use

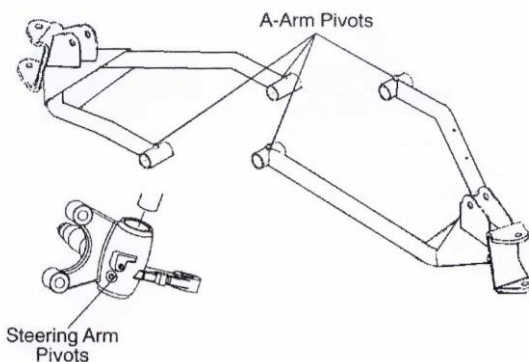



## Engine Oil

Always check and change the engine oil at the intervals outlined in the Periodic Maintenance Chart beginning on page 58. Oil may need to be changed more frequently if Yours oil is not used. Do not use automotive oil. see page 99 for the part numbers of Yours products.

### Oil Recommendations

These Operating Conditions	Use This Recommended Oil
Outside air temperature is above 32°F/0°	Yours Synthetic Youth Oil(or Synthetic SAE40)
Outside air temperature is below 32°F/0°	Semi-Synthetic 20W-40

#### NOTICE:

Mixing brands or using a non-recommended oil may cause serious engine damage. Always use the recommended oil. Never substitute or mix oil brands.

#### Oil Check

Maintain the oil level within the safe range on the dipstick.  
Do not overfill.

1. Position the vehicle on a level surface.
2. Remove the dipstick. Wipe it dry with a clean cloth.
3. Reinstall the dipstick completely.
4. Remove the dipstick and check the oil level.

Tip: A rising oil level between checks in cool weather driving can indicate contaminants such as gas or moisture collecting in the crankcase. If the oil level is over the full/safe mark, change the oil immediately.

5. Add the recommended oil as needed.
6. Reinstall the dipstick.



Dipstick

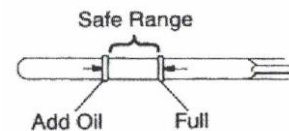

## Engine Oil

1. Position the vehicle on a level surface. Set the parking brake.
2. Clean the area around the pre-filter plug.
3. Start the engine. Allow it to idle for two to three minutes.
4. Stop the engine.



Hot oil can cause burns to skin. Do not allow hot oil to contact skin.

5. Place a drain pan under the engine crankcase.
6. Remove the pre-filter plug. Allow the oil to drain completely.
7. Wash the oil pre-filter screen with solvent to remove debris. Allow the screen to air dry.
8. Clean the pre-filter plug. Install a new sealing washer on the plug. The sealing surfaces on the pug and crankcase should be clean and free of burrs, nicks or scratches.
9. Reassemble the pre-filter screen and spring to the pre-filter plug
10. Reinstall the pre-filter drain plug. Torque to 11.lbs.(15Nm).
11. Remove the dipstick. Add 30 oz.(0.9 liters)of the recommended oil. Do not overfill. See the specifications section beginning on page 97 for capacities.
12. Reinstall the dipstick.
13. Start the engine. Allow it to idle for one to two minutes.
14. Stop the engine and inspect for leaks.
15. Check the oil level. Add oil as needed to bring the level to the upper mark on the dipstick.
16. Dispose of used oil properly.





### Transmission (Main Gear case)

Always check and change the fluid at the intervals outlined in the Periodic Maintenance Chart beginning on page 58. Yours recommends the use of Premium AGL Synthetic Gear case Fluid for this vehicle.

#### Fluid Check

The fill plug is located on the rear of the gear case. Access the fill plug through the left rear wheel well. Maintain the fluid level at the bottom of the fill plug hole.

1. Position the vehicle on a level surface.
2. Remove the fill plug.
3. Check the fluid level.
4. Add the recommended fluid as needed.
5. Reinstall the fill plug.

#### Fluid Change

The drain plug is located on the bottom of the gear case.

1. Remove the fill plug.
2. Place a drain pan under the drain plug.
3. Remove the drain plug. Allow the fluid to drain completely.
4. Clean the drain plug.
5. Reinstall the drain plug with a new o-ring. Torque to 11ft.lbs.(15Nm).
6. Add 3.3 oz.(110ml)of the recommended fluid to the fill hole. Maintain the fluid level at the bottom of the fill plug hole. Do not overfill.
7. Reinstall the fill plug.
8. Check for leaks.
9. Discard used fluid properly.



### Drive Chain Lubrication

Lubricate the drive chain with Yours chain spray lube or an approved chain lube at the general lubrication interval specified in the Periodic Maintenance Chart beginning on page 58. Lubricate more often under severe use. Such as in dirty or wet conditions. See page 99 for the part numbers of yours products.

#### NOTICE:

Washing the drive chain with a high pressure washer or gasoline can cause premature wear and drive chain failure. Don't use a high pressure washer or gasoline to clean the drive chain.

Adjusting or operating the vehicle with improper rear drive chain slack can result in severe damage to the transmission and drive components. Always make sure the slack is within the stated specifications.

#### Drive Chain Slack

1. Check the amount of chain slack by moving the vehicle slightly forward to gain slack at the top side of the chain.
2. Raise the rear of the vehicle and support securely under the mainframe. Allow the swing arm to hang at full shock extension without touching the ground. This establishes the tightest chain position.
3. Pull down on the chain tensioner to move it out of the way, Then measure chain slack. It should have 1/4"-1/2" (6-12mm) deflection.
4. If the chain needs adjustment, use the procedure on page 68.

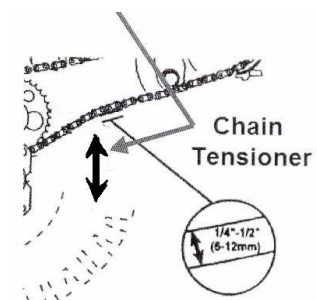
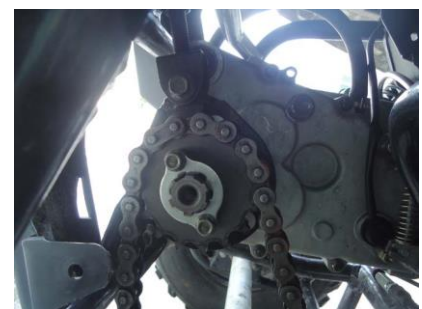

### Drive Chain Slack Adjustment

1. Loosen the one rear housing mount bolts .
2. Loosen the chain adjuster lock nuts.
3. Turn the chain adjusters clockwise to 1/4"-1/2"(6-12mm) deflection.
4. Tighten the chain adjuster lock nuts to 43 ft. lbs.(60Nm).Hold the adjuster stud securely while tightening the nut to avoid breaking tile stud.
5. Tighten the four rear housing mount bolts to 18 ft. lbs.(25Nm).



Housing mount bolts



Chain adjusters

### Spark Plugs

#### Spark Plugs Gap/Torque

Electrode Gap	New Plug Torque	Used Plug Torque
0.6-0.7mm	9-11 ft. lbs.(12-15Nm)	17-20 ft. lbs.(23-27Nm)

#### NOTICE:

Using non-recommended spark plugs can result in serious engine damage. Always use Yours-recommended spark plugs. Refer to the specifications section beginning on page 97. Spark plug condition is indicative of engine operation. The spark plug firing end condition should be read after the engine is warmed up and the vehicle is driven at higher speeds. Immediately check the spark plug for correct color.



A hot exhaust system and engine can engine can cause burns. Wear protective gloves when removing a spark plug for inspection.

## Spark Plug Gap/Torque Normal Plug

The normal insulator tip is gray, tan or light brown. There will be few combustion deposits. The electrodes are not burned or eroded. This indicates the proper type and heat range for the engine and the service.

**lip:** The tip should not be white. A white insulator tip indicates overheating, caused by use of an improper spark plug or incorrect throttle body adjustments.

## Wet Fouled Plug

The wet fouled insulator tip is black. A damp oil film covers the firing end.

There may be a carbon layer over the entire nose. Generally, the electrodes are not worn. General causes of fouling are excessive oil, use of non-recommended oil, improper use of the choke, or incorrect throttle Body / carburetor adjustments.

## Spark Plug Removal and Replacement

1. Remove the spark plug cap.
2. Using the spark plug wrench provided in the tool kit, remove the plug by rotating it counter-clockwise.
3. Reverse the procedure for spark plug installation.
4. Torque to specification.

68

## Constant Variable Transmission (CVT) System

### **! WARNING**

Failure to comply with the instructions in this warning can result in severe injury or death.

Do not modify any component of the CVT system. Doing so may reduce its strength so that a failure may occur at a high speed. The CVT system has been precision balanced. Any modification will cause the system to be out of balance, creating vibration and additional loads on components.

The CVT system rotates at high speeds, creating large amounts of force on clutch components. Extensive engineering and testing has been conducted to ensure the safety of this product. However, as the owner, you have the following responsibilities to make sure this system remains safe:

- Always follow all recommended maintenance procedures. See your dealer as outlined in the owner's manual.
- This CVT system is intended for use on your products only. Do not install in any other product.
- Always make sure the CVT housing is securely in place during operation.

### CVT Drying

There may be some instances when water is accidentally ingested into the CVT system. Use the following instructions to dry it out before operating. The drain plug is located on the bottom of the CVT cove.

1. Remove the drain plug. Allow the water to drain. Reinstall the drain plug.
2. Shift the transmission to neutral, set the parking brake.
3. Start the engine. Apply varying throttle for 10-15 seconds to expel the moisture and air-dry the belt and clutches. Do not hold the throttle wide open for more than 10 seconds.
4. Allow the engine RPM to settle to idle speed.
5. Test for belt slippage. If the belt slips, repeat the process.
6. Take the vehicle to your dealer for service as soon as possible.

**NOTICE:** Exposure to salt water will cause corrosion to metal components. If your vehicle is operated in salt water areas, rinse it off frequently with fresh water.

## Filter Systems

### Air Filter

Always change the air filter at the intervals outlined in the Periodic Maintenance Chart beginning on page 58. Access cover on the forward surface of the rear body panel.

1. Move or remove the storage bag.
2. Remove the four (4) access cover fasteners to remove the access cover.
3. Release the air box cover spring clips and remove the cover.
4. Remove the foam air filter. Wash the foam filter in warm soapy water, then rinse and let dry. If the filter is damaged, install a new foam filter.
5. Apply a commercially available foam filter lubricant to the foam filter.
6. Clean away any oil or sediments in the air box.
7. Reinstall the filter and air box cover. Secure the clips.

#### NOTICE:

Never operate the vehicle with the filter element removed, Dirt will enter the engine, causing rapid wear and severe damage to the engine.

8. Reinstall the access cover, and storage bag.



Access cover



Foam filter

## Spark Arrestor (If there is in design)

### **! WARNING**

Failure to heed the following warnings while servicing the spark arrestor could result in serious injury or death.

- Do not perform service on the spark arrestor while the system is hot. Allow components to cool sufficiently before proceeding.
- Wear eye protection and gloves.
- Never run the engine in an enclosed area. Exhaust contains poisonous carbon monoxide gas.

To remove accumulated carbon, clean the spark arrestor at the intervals recommended in the Periodic Maintenance Chart beginning on page 58.

1. Remove the six bolts and remove the arrestor from the end of the muffler.
2. Use a non-synthetic brush to clean the arrestor screen. A synthetic brush may melt if components are warm. If necessary, blow debris from the screen with compressed air.
3. Inspect the screen for wear and damage. Replace the arrestor if damage is found.
4. Reinstall the arrestor.
5. Torque the bolts to 7 ft. lbs.(9.5 Nm).

## Throttle System

### **! WARNING**

Failure to check or maintain proper operation of the throttle system can result in an accident and lead to serious injury or death if the throttle pedal sticks during operation.

Never start or operate this vehicle if it has a sticking or improperly operating throttle pedal.

Immediately contact your dealer for service if throttle problems arise.

Always check the pedal for free movement and return before starting the engine and occasionally during operation.

### Throttle Free play

If the throttle pedal has excessive play due to cable stretch or maladjustment, it will cause a delay in throttle response, especially at low engine speed. The throttle may also not open fully. If the throttle pedal has no free play, the throttle may be hard to control, and the idle speed may be erratic.

Check the throttle pedal free play at the intervals outlined in the Periodic Maintenance Chart beginning on page 58. Adjust the free play if necessary.

### Throttle Free play Inspection

1. Place the transmission in neutral. Set the parking brake.
2. Start the engine. Allow it to warm up thoroughly.
3. Measure the distance the throttle pedal moves before the engine begins to pick up speed. Free play should be 1/16 to 1/8 inches (1.5-3mm).



Brake pedal      Throttle pedal

## Throttle System

### Throttle Free play Adjustment

Access the throttle cable adjuster through the right front wheel well.

1. Slide the cable adjuster boot off the cable adjuster.
2. Squeeze the end of the rubber boot and slide it far enough to expose the end of the inline cable adjuster.
3. Loosen the adjuster lock nut.
4. Move the cable adjuster until 1/16" to 1/8" (1.5-3mm) of free play is achieved at the throttle pedal. See page 74. While adjusting, lightly flip the throttle pedal up and down.
5. Tighten the lock nut.
6. Apply a small amount of grease to the inside of the boot and slide it over the cable adjuster to its original position.

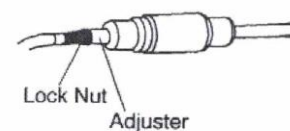
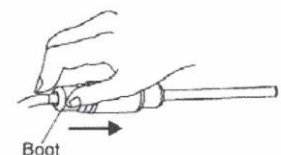

## Carburetor

Your vehicle is calibrated at the factory for optimal performance at altitudes ranging from zero to 6,000 feet (1800m) and temperatures of +40 degrees F. (4 degrees C.) or higher. Above 6000 feet (1800m) the engine air/fuel mixture becomes overly rich and the engine loses approximately 3% of its power for each 1000-foot (304.8 in) increase in elevation. Although this power cannot be regained, adjustments to the carburetor and drive system can be made to allow more efficient operation. Optional jets, available from your dealer, are required for operation above 6,000 feet and temperatures below +40 degrees F. (4 degrees C.)

**Tip:** Continuous operation of the engine without proper jetting when required can cause poor performance, overheating, or engine damage. See your dealer for more information about jetting the vehicle for conditions in your area.

### Carburetor/Engine Idle RPM Adjustment

If the engine's idle speed is not satisfactory and all other conditions are favorable, the carburetor can be adjusted.

1. Place the transmission in neutral.
2. Set the parking brake.
3. Start the engine and allow it to warm up for approximately five minutes.
4. Turn the carburetor idle screw in (clockwise) to raise RPM. Turn the screw out (counterclockwise) to lower RPM.



74

## Brakes

The front and rear brakes are hydraulic disc type brakes activated by the brake pedal. See page 39. Always check brake pedal travel and the brake fluid reservoir level before each use of the vehicle. When applied, the brake pedal should feel firm. Any sponginess would indicate a possible fluid leak or low brake fluid level, which must be corrected before riding. See page 78 for brake fluid information.

If you discover any irregularities in brake system operation, including excessive pedal travel, contact your dealer for proper diagnosis and repairs.



Operating the vehicle with a spongy brake pedal can result in loss of braking, which could cause an accident resulting in severe injury or death. Never operate the vehicle with a spongy-feeling brake pedal.

### Brake Inspection

1. Check the brake system for fluid leaks.
2. Check the brake pedal for excessive travel or a spongy feel.
3. Check the friction pads for wear, damage and looseness.
4. Inspect the brake pad wear surface for excessive wear.
5. Change pads when worn to 3/64" (1mm).

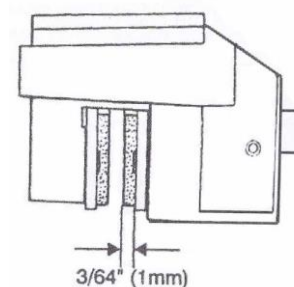

75



## Brakes

### Brake Fluid

Inspect the level of the brake fluid before each operation. If the fluid level is low add DOT 4 brake fluid only. See page 99 for the part numbers of yours products.



After opening a bottle of brake fluid, always discard any unused portion, Never store or us a partial bottle. Brake fluid is hygroscopic meaning it rapidly absorbs moisture from the air. The moisture causes the boiling temperature of the brake fluid to drop, which can lead to early brake fade and the possibility of accident or severe injury.

Change tile brake fluid every two year any time the fluid becomes contaminated, the fluid level is below the minimum, or if the type and brand of the fluid in the, reservoir are unknown.

Access the brake fluid reservoir through the left front wheel well.

1. Position the vehicle on a level surface.
2. Place the transmission in neutral. Set the parking brake.
3. View the brake fluid level in the reservoir. The level should be between the maximum and minimum level lines. Add brake fluid as needed.
4. Apply the brake forcefully for a few seconds and check for fluid leakage around the fittings.

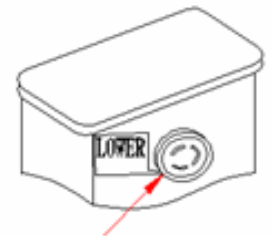

inspection Opening

76

### Steering Wheel Inspection

Check the steering wheel for specified and smooth operation at the intervals outlined in the Periodic Maintenance Chart beginning on page 58.

1. Position the vehicle on level ground.
2. Lightly turn the steering wheel left and right.
3. There should be 0.8"-1.0" (20-25mm) of free play.
4. If there is excessive free play or strange noises, or the steering feels rough or "catchy," have the steering system inspected by an authorized yours dealer.

### Shock Spring Adjustment

The front and rear shock absorber springs are adjustable to increase or decrease spring tension. Rotate the adjuster either clockwise or counter-clockwise to make adjustments. Always apply the same adjustment setting to all four wheels.

**WARNING!** Uneven adjustment may cause poor handling of the vehicle, which could result in an accident. Always adjust both the left and right spring preloads equally or have your yours dealer perform the adjustments.

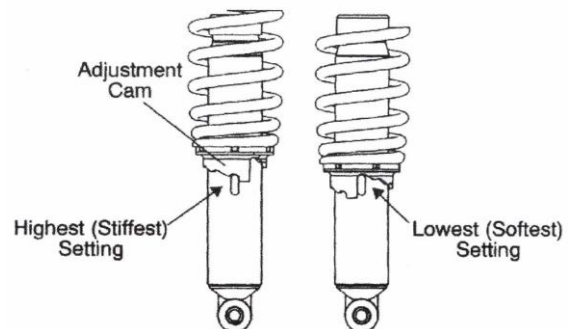

77

## MAINTENANCE

### Toe Alignment

Use the following procedure to check the toe alignment of the vehicle. The recommended toe alignment is 1/8" to 1/4" (3-6mm) toe out.

#### **WARNING!**

Severe injury or death can result from improper toe alignment and adjustment. Do not attempt to adjust tie rod alignment. All tie rod adjustments should be performed by an authorized yours dealer.

1. Position the vehicle on a level surface.
2. Set the handlebars in a straight-ahead position and secure them in this position.
3. Place a chalk mark on the center line of the front tires approximately 10"(25.4 cm) from the floor, or as close to the hub / axle center line as possible. Make sure both marks are the same distance from the floor.
4. Measure the distance between the marks and record the measurement(1).
5. Move the vehicle to rotate the tires 180°. Position the wheels with the chalk marks at the rear of the tires, even with the hub/axle center line.
6. Measure the distance between the marks and record the measurement (2).
7. Subtract measurement 2 from measurement 1. The difference is the vehicle toe-out alignment.
8. If you discover improper alignment, see your dealer for service.



78

### Tires

#### **WARNING**

Operating your vehicle with worn tires will increase the possibility of skidding, loss of control and an accident, which could result in serious injury or death,

Always replace tires when the tread depth measures 1/8"(3mm) or less.

Improper tire inflation or the use of non-standard size or type of tires may adversely affect vehicle handling, which could result in vehicle damage or personal injury. Always maintain proper tire pressure. When replacing tires, always use original equipment size and type.

#### **Tire tread Depth**

Always replace tires when tread depth is worn to 1/8"(3 mm) or less.

#### **Front Wheel Hub Tightening**

Front wheel bearing tightness and spindle nut retention are Critical component operations. All service must be performed by your authorized dealer.

#### **Wheel Removal**

1. Position the vehicle on a level surface.
2. Place the transmission in neutral. Set the parking brake. Stop the engine.
3. Loosen the wheel nuts slightly.
4. Elevate the side of the vehicle by placing a suitable stand under the frame.
5. Remove the wheel nuts. Remove the wheel.

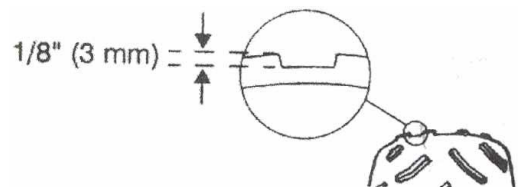

79



## Tires

### Wheel Installation

1. Place the transmission in neutral.
2. Set the parking brake.
3. Place the wheel on the wheel hub with the valve stem toward the outside and the rotation arrows on the tire pointing toward forward rotation.
4. Attach the wheel nuts and finger tighten.
5. Carefully lower the vehicle to the ground.
6. Torque the wheel nuts to specification.

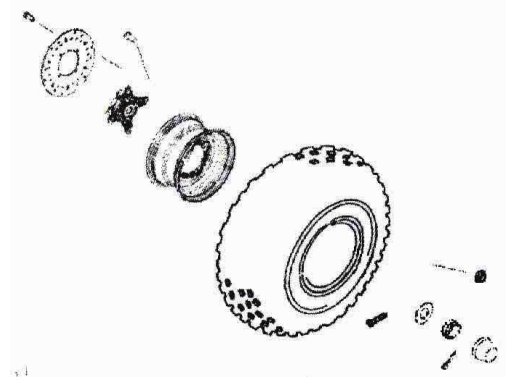

Improperly installed wheels can adversely affect tire wear and vehicle handling, which can result in serious injury or death. Always ensure that all nuts are torqued to specification. Do not service axle nuts that have a cotter pin installed. See your dealer.

### Wheel Nut Torque Specifications

Check the wheel nut torques occasionally and when they've been loosened for service.

Location	Nut Torque
Front Wheel	27 ft. lbs.(37 Nm)
Rear wheel	27 ft. lbs.(37 Nm)

80

## Lights

### Daytime Running Lights Lamp Replacement

If the daytime running lights do not operate, replace the lamps. Yours recommends that you install replacement lamps obtained from your authorized Yours dealer.

1. Disconnect the lights from the harness.
2. Remove the rubber cover from the back of the light assembly.
3. Press the lamp retainer inward and turn it counter-clockwise to remove it. Note the position of the lamp positioning tab, then carefully pull the lamp out.
4. Install the new lamp. Make sure the filament is horizontal.
5. Reinstall the lamp retainer. Press the retainer inward and turn it clockwise about 1/4 turn.
6. Start the engine to make sure the lights come on. If the lights do not operate, see your Yours dealer for service.
7. Reinstall the rubber cover, and reconnect the lights to the harness.

### Tail Light Lamp Replacement

If the brake light doesn't work, the lamp may need to be replaced.

1. Remove the two screws securing the lens cover. Remove the lens cover.
2. Remove the lamp and replace it with a new recommended lamp.
3. Test the light for proper operation.
4. Reinstall the lens cover.

81

## Vehicle immersion

### NOTICE:

If your vehicle becomes immersed, major engine damage can result if the machine is not thoroughly inspected. Take the vehicle to your dealer before starting the engine. If it's impossible to take your vehicle to a dealer before starting it, follow the steps outlined below.

1. Move the vehicle to dry land.
2. Turn the fuel valve off.
3. Check the air box. If water is present, dry the air box and replace the filter with a new filter. Thoroughly dry the air pre-filter. See page 72.
4. Remove the spark plugs.
5. Loosen the carburetor drain screw.
6. Turn the engine over several times.
7. Dry the spark plugs and reinstall them, or install new plugs.
8. Tighten the carburetor drain screw.
9. Turn the fuel valve on.
10. Attempt to start the engine. If necessary, repeat the drying procedure.
11. Take the vehicle to your dealer for service as soon as possible, whether you succeed in starting it or not.
12. If water has been ingested into the transmission follow the procedure on page 71 for drying.



## 82 Battery

### **!WARNING**

Improperly connecting or disconnecting battery cables can result in an explosion and cause serious injury or death. When reinstalling the battery, always disconnect the negative (black) cable first. When reinstalling the battery, always connect the negative (black) cable last.

### **!WARNING**

Battery electrolyte is poisonous. It contains sulfuric acid. Serious burns can result from contact with skin, eyes or clothing.

**External:** Flush with water.

**Internal:** Drink large quantities of water or milk. Follow with milk of magnesia, beaten egg, or vegetable oil. Call physician immediately.

**Eyes:** Flush with water for 15 minutes and get prompt medical attention.

Batteries produce explosive gases. Keep sparks, flame, cigarettes, etc. away. Ventilate when charging or using in an enclosed space. Always shield eyes when working near batteries. **KEEP OUT OF REACH OF CHILDREN.**

Your vehicle may have either a sealed battery, which requires little maintenance, or a conventional battery. A sealed battery can be identified by its flat covers on the top of the battery. A conventional battery has six filler caps on the top of the battery.

Always keep battery terminals and connections free of corrosion. If cleaning is necessary, remove the corrosion with a stiff wire brush. Wash with a solution of one tablespoon baking soda and one cup water. Rinse well with tap water and dry off with clean shop towels. Coat the terminals with dielectric grease or petroleum jelly. Be careful not to allow cleaning solution or tap water into a conventional battery.

## Battery

### Battery Removal

1. Remove the driver's seat. See page 31.
2. On conventional batteries, remove the battery vent tube (sealed batteries do not have a vent tube).
3. Disconnect the black (negative) battery cable first.
4. Disconnect the black (positive) battery cable last.
5. Lift the battery out of the vehicle. Be careful not to tip a conventional battery sideways, which could spill electrolyte.

#### NOTICE:

If electrolyte spills, immediately wash it off with a solution of one tablespoon baking soda and one cup water to prevent damage to the vehicle.

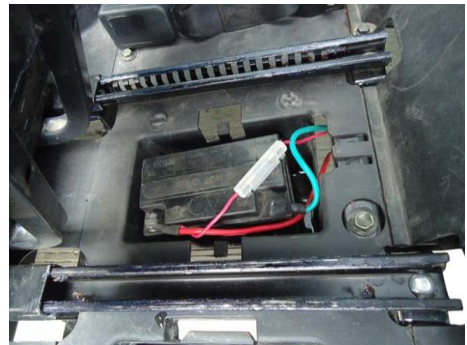

## Battery

### Battery Installation

Using a new battery that has not been fully charged can damage the battery and result in a shorter life. It can also hinder vehicle performance. Follow the battery charging instructions on page 89 before installing the battery.

1. Ensure that the battery is fully charged.
2. Place the battery in the battery holder.
3. On conventional batteries, install the battery vent tube. The vent tube must be free of obstructions and securely installed. Route the tube away from the frame and vehicle body to prevent contact with electrolyte.



Battery gases could accumulate in an improperly installed vent tube and cause an explosion, resulting in serious injury or death. Always ensure that the vent tube is free of obstructions and is securely installed as recommended.

4. Coat the terminals with dielectric grease or petroleum jelly.
5. Connect and tighten the red (positive) cable first.
6. Connect and tighten the black (negative) cable last.
7. Verify that cables are properly routed.
8. Reinstall the driver's seat.

## Battery

### Battery Storage

Whenever the vehicle is not used for a period of three months or more, remove the battery from the vehicle, ensure that it's fully charged, and store it out of the sun in a cool, dry place. Check battery voltage each month during storage and recharge as needed to maintain a full charge. See page 89.

**Tip:** Battery charge can be maintained by using a Yours Battery Tender charger or by charging about once a month to make up for normal self-discharge. Battery Tender can be left connected during the storage period, and will automatically charge the battery if the voltage drops below a pre-determined point. See page 99 for the part numbers of Yours products.

### Battery Fluid (Conventional Battery)

A poorly maintained battery will deteriorate rapidly. Check the battery fluid level often. Maintain the fluid level between the upper and lower level marks.

Add only distilled water. Tap water contains minerals that are harmful to a battery.

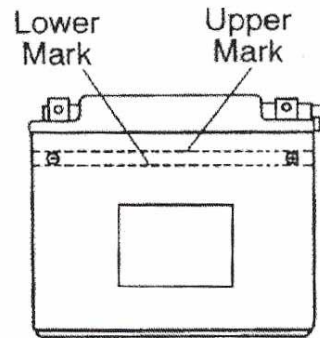

86

## Battery

### Battery Charging (Conventional Battery)

1. Remove the battery from the vehicle to prevent damage from leaking or spilled electrolyte during charging.
2. Charge the battery with a charging output no larger than 1/10 of the battery's amp / hr rating. Charge as needed to raise the specific gravity to 1.270 or greater.
3. Reinstall the battery. See page 87. Make sure the positive terminal is toward the front of the vehicle.

### Battery Charging (Sealed Battery)

The following battery charging instructions apply only to the installation of a sealed battery. Read all instructions before proceeding with the installation of this battery.

The sealed battery is already filled with electrolyte and has been sealed and fully charged at the factory. Never pry the sealing strip off or add any other fluid to this battery.

The single most important thing about maintaining a sealed battery is to keep it fully charged. Since the battery is sealed and the sealing strip cannot be removed, you must use a voltmeter or multimeter to measure DC voltage.



An overheated battery may explode, causing severe injury or death. Always watch charging times carefully. Stop charging if the battery becomes very warm to the touch. Allow it to cool before resuming charging.

For a refresh charge, follow all instructions carefully.

1. Check the battery voltage with a voltmeter or multimeter. A fully charged battery will register 12.8 V or higher.
2. If the voltage is less than 12.8 volts, recharge the battery at 1.2 amps or less until battery voltage is 12.8 or greater.

**Tip:** When using an automatic charger, refer to the charger manufacturer's instructions for recharging. When using a constant current charger, use the guidelines on the next page for recharging.

## Battery

### Battery Charging (Sealed Battery)

Always verify battery condition before and 1-2 hours after the end of barging.

State of charge	Voltage	Action	Charge Time (Using constant current charger @ standard amps specified on top battery)
100%	12.8-13.0 volts	None, check at 3 mos. from date of manufacture	None required
5%-100%	12.5-12.8 volts	May need slight charge, if no charge, given check in 3 months	3-6 hours
50%-75%	12.0-12.5 volts	Needs charge	5-11 hours
25%-50%	11.5-12.0 volts	Needs charge	At least 13 hours, verify state of charge
0%-25%	11.5 volts or less	Needs charge with Desolating charger	At least 20 hours

## Cleaning and Storage

### Washing the Vehicle

Keeping your vehicle clean will not only improve its appearance but it can also extend the life of various components.

Before washing the vehicle, locate the CVT inlet and outlet ducts. The ducts are located under the rear wheel wells. Avoid spraying water directly toward the ducts when washing the vehicle from the rear.

#### NOTICE:

Water in the CVT system could cause the drive belt to become wet and slip in the clutches. Always avoid spraying water directly toward the CVT inlet and outlet ducts when washing the vehicle from the rear.

High water pressure may damage components. Yours recommends washing the vehicle by hand or with a garden hose, using mild soap.

Certain products, including insect repellents and chemicals, will damage plastic surfaces. Do not allow these types of products to contact the vehicle.

The best and safest way to clean your vehicle is with a garden hose and a pail of mild soap and water.

1. Use a professional-type washing cloth, cleaning the upper body first and the lower parts last.
2. Rinse with clean water frequently.
3. Dry surfaces with a chamois to prevent water spots.

#### Washing Tips

- Avoid the use of harsh cleaners, which can scratch the finish.
- Do not use a power washer to clean the vehicle.
- Do not use medium to heavy duty compounds on the finish.
- Always use clean cloths and pads for cleaning and polishing. Old or reused cloths and pads may contain dirt particles that will scratch the finish.

## **Cleaning and Storage**

### **Washing the Vehicle**

If a high pressure water system is used for cleaning (not recommended), exercise extreme caution. The water may damage components and could remove paint and labels. Avoid directing the water stream at the following items:

- Wheel bearings
- Radiator
- Transmission seals
- CVT inlet and outlet ducts
- Brakes
- Cab and body panels
- Labels and decals
- Electrical components and wiring

If an informational or graphic label becomes illegible or comes off, contact your dealer to purchase a replacement. Replacement safety labels are provided by your dealer at no charge.

Grease all zerk fittings immediately after washing. Allow the engine to run for a while to evaporate any water that may have entered the engine or exhaust system.

### **Polishing the Vehicle**

Yours recommends the use of common household aerosol furniture polish for polishing the finish on your vehicle. Follow the instructions on the container.

#### **Polishing Tips**

- Avoid the use of automotive products, some of which can scratch the finish of your vehicle.
- Always use clean cloths and pads for cleaning and polishing. Old or reused cloths and pads may contain dirt particles that will scratch the finish.

90

## **Cleaning and Storage**

### **Chrome Wheel Care (if equipped)**

Proper maintenance will protect chrome wheels from corrosion, preserve wheel life and ensure a “like new” appearance for many years.

**Tip:** Chrome wheels exposed to road salt (or salt in the air in coastal areas) are more susceptible to corrosion if not properly cleaned. Clean chrome wheels more often if they’re exposed to salt or other corrosive elements.

1. Wash chrome wheels frequently. Use a mild detergent. Never use abrasive cleaners on plated or painted surfaces.
2. Rinse well clear water. Soap, detergents, salt, dirt, mud and other elements can cause corrosion.
3. Polish the clean chrome wheels periodically. Use an automotive grade chrome polish.
4. Routinely and liberally apply a weather resistant wax to each polished chrome wheel. Choose a product suitable for chrome finishes. Read and follow the product labels and instructions.

### **Removing Corrosion**

If light rust is found on the chrome finish, use steel wool (#0000-OTT grade) to remove it. Gently rub the affected areas with the steel wool until the corrosion has been removed. Clean and polish the wheel as outlined above.

91

## **Cleaning and storage**

### **Storage Tips**

#### **NOTICE:**

Starting the engine during the storage period will disturb the protective film created by fogging and damage could occur. Never start the engine during the storage period.

#### **Clean the Exterior**

Make any necessary repairs and clean the vehicle as recommended. See page 91.

#### **Stabilize the Fuel**

1. Fill the fuel tank.
2. Add Your Carbon Clean Fuel Treatment or Your Fuel Stabilizer. Follow the instructions on the container for the recommended amount. Carbon Clean removes water from fuel systems, stabilizes fuel and removes carbon deposits from pistons, rings, valves and exhaust systems.
3. Allow the engine to run for 15-20 minutes to allow the stabilizer to disperse through the fuel in the tank and carburetor.
4. Turn the fuel valve off.
5. Drain the carburetor bowl.

#### **Air Filter/Air Box**

Inspect and clean or replace the pre-filter and air filter. See page 72. Clean the air box. Drain the sediment tube.

#### **Fluid Levels**

Inspect the fluid levels. Add or change fluids as recommended in the Periodic Maintenance Chart beginning on page 58.

- Transmission fluid
- Brake fluid (change every two years and any time the fluid looks dark or contaminated)

#### **Engine oil**

Change the oil. See page 65.

92

## **Cleaning and Storage**

### **Storage Tips**

#### **Inspect and Lubricate**

Inspect all cables and lubricate all areas of the vehicle as recommended in the Periodic Maintenance Chart beginning on page 58.

#### **Fog the Engine**

Use Your Engine Fogging Oil. Follow label directions carefully.

#### **Battery Maintenance**

See pages 88-90 for storage and charging procedures.

#### **Storage Area/Covers**

Be sure the storage area is well ventilated. Cover the vehicle with a genuine cover. Do not use plastic or coated materials. They do not allow enough ventilation to prevent condensation, and may promote corrosion and oxidation.

#### **Removal from Storage**

1. Check the battery electrolyte level and charge the battery if necessary. Install it in the vehicle. Make sure the battery vent hose is routed properly and that it's not pinched or restricted in any way.
2. Make sure the spark plug is tight.
3. Fill the fuel tank with fuel.
4. Check all the points listed in the Daily Pre-Ride Inspection section on page 43. Tightness of the bolts, nuts and other fasteners should be checked by an authorized dealer.
5. Lubricate at the intervals outlined in the Periodic Maintenance Chart beginning on page 58.

### Transporting the Vehicle

Follow these procedures when transporting the vehicle.

1. Place the transmission in neutral. Set the parking brake.
2. Stop the engine.
3. Turn the fuel valve off.
4. Remove the key to prevent loss during transporting.
5. Secure the fuel cap and seats.

**NOTICE:**

Always tie the frame of the vehicle to the transporting unit securely with suitable straps or rope. Do not attach tie straps to the front control arm bolt pockets.

6. Wrap the front tie strap through the frame tubes, or attach a tie-down hook around each of the tubes.
7. Wrap the rear tie strap around the swing arm.

## 94

### SPECIFICATIONS

<b>GKV200</b>	
Maximum Rider Weight	75 kg(each rider)
Maximum Weight Capacity	150Kg
Gross Vehicle Weight	402kg
Dry weight	252 kg
Fuel Capacity	11.0 ltr
Engine Oil Capacity	0.9 ltr
Transmission Oil Capacity	0.11 ltr
Overall Length x Width x Height	2440x1220x1470mm
Wheelbase	1860mm
Ground Clearance	130mm
Engine Type	4-Stroke
Displacement	168.9 cc
Cooling	air-cooled
Bore x stroke	61mm x 57.8mm
Alternator Output	110 watts
Compression Ratio	9.2:1
Starting System	Electric
Ignition System	CDI
Spark Plug/Gap	A7TC/0.6-0.7mm



**SPECIFICATIONS**

<b>GKV200</b>	
Lubrication System	Wet Sump
Driving System Type	Automatic Constant Variable Transmission
Final Drive	Chain
Shift Type	F/N/R
Tire Size-Front	21x7-10
Tire Size-Rear	22x10-10
Tire Pressure-Front	24 psi (170kPa)
Tire Pressure-Rear	24 psi (170kPa)
Brakes, Front/Rear	Foot Activated, 4-wheel hydraulic disc
Parking Brake	Mechanical, Rear(Lever)
Daytime Running Lights	Dual, Standard
Brake Light	Standard

**TROUBLESHOOTING****Drive Belt Wear/Burn**

<b>Part cause</b>	<b>Solution</b>
Driving at low RPM or ground speed	Drive at a higher speed.
Insufficient warm-up at low ambient temperatures	Warm the engine at least 5 minutes. With the transmission in neutral, apply small amount of throttle in short bursts, 5 to 7 times. The belt will become more flexible and prevent belt burning.
Slow/easy clutch engagement	Use the throttle quickly and effectively.
Belt slippage from water or snow ingestion into the CVT system	Dry out the CVT (see page 71). Prevent water from entering the CVT inlet and outlet ducts (see page 91). Inspect clutch seals for damage if repeated leaking occurs.
Clutch malfunction	See your dealer
Poor engine performance	Check for fouled plugs or foreign material in gas tank or fuel lines. See your dealer.
Wrong or missing belt	Install the recommended belt.
Improper break-in	Always break in a new belt and/or clutch. See page 41.

**Engine Doesn't Turn Over**

<b>Possible Cause</b>	<b>Solution</b>
Low battery voltage	Recharge the battery to 12.8 VDC
Loose battery connections	Check all connections and tighten
Loose solenoid connections	Check all connections and tighten

**Engine Turns Over, Fails to Start**

<b>Possible Cause</b>	<b>Solution</b>
Out of fuel	Turn the fuel valve to reserve, refuel
Clogged fuel valve or filter	Inspect and clean or replace
Water is present in fuel	Drain the fuel system and refuel
Ole or non-recommended fuel	Replace with fresh recommended fuel
Fuel valve is turned off	Turn the fuel valve on
Fouled or defective spark plugs	Inspect plugs and replace if necessary
No spark to spark plug	Inspect plugs and replace if necessary
Water or fuel in crankcase	Immediately see your Yours dealer
Overuse of choke	Inspect, clean and/or replace spark Plugs
Clogged fuel filter	Replace the filter
Low battery voltage	Recharge the battery to 12.8 VDC
Mechanical failure	See your dealer

**Engine Backfires**

<b>Possible Cause</b>	<b>Solution</b>
Weak spark from spark plug	Inspect, clean and/or replace spark plugs
Incorrect spark plug gap or heat range	Set gap to specs or replace plugs
Old or non-recommended fuel	Replace with fresh recommended fuel
Incorrectly installed spark plug wires	See your dealer
Incorrect ignition timing	See your dealer
Mechanical failure	See your dealer
Loose ignition connections	Check all connections and tighten
Water present in fuel	Replace with fresh recommended fuel
Exhaust system leak	See your dealer

**Engine Pings or Knocks**

<b>Possible Cause</b>	<b>Solution</b>
Poor quality or low octane fuel	Replace with recommended fuel
Incorrect ignition timing	See your dealer
Incorrect spark plug gap or heat range	Set gap to specs or replace plugs

**Engine Runs Irregularly, Stalls or Misfires**

<b>Possible Cause</b>	<b>Solution</b>
Fouled or defective spark plugs	Inspect, clean and/or replace sparkplugs
Worn or defective spark plug wires	See your dealer
Incorrect spark plug gap or heat range	Set gap to specs or replace plugs
Loose ignition connections	Check all connections and tighten
Water present in fuel	Replace with new fuel
Low battery voltage	Recharge battery to 12.8 VDC
Kinked or plugged fuel tank vent line	Inspect and replace
Incorrect fuel	Replace with recommended fuel
Clogged air filter	Inspect and clean or replace
Electronic throttle control malfunction	See your dealer
Other mechanical failure	See your dealer
<b>Possible Lean Fuel Cause</b>	<b>Solution</b>
Low or contaminated fuel	Add or change fuel, clean the fuel system
Low octane fuel	Replace with recommended fuel
Clogged fuel filter	See your dealer
Incorrect fuel	Replace with recommended fuel
Incorrect jetting	See your dealer



DATE	MILES(KM) OR HOURS	TECHNICIAN	SERVICE PERFORMED/COMMENTS

 **102  
! WARNING**

Improper vehicle use can result in SEVERE INJURY or DEATH **NEVER** allow vehicle to be operated:

- Without all occupants first viewing and understanding safety video and warning labels.
- With more than one passenger.
- On hills steeper than 15 degrees  $\angle 15^\circ$ .
- On paved surfaces-pavement may seriously affect handling and control.
- With non-Yours approved accessories-they may seriously affect stability.
- At speeds that are too fast for the operator’s skills, the conditions and /or the terrain.

**ALWAYS** require operator and passenger to:

- Wear seat belts; grab hand holds (passenger) and plant feet firmly on the floor.
- Secure cab nets.
- Keep hands and feet inside vehicle.
- Reduce speed and use extra caution when carrying a passenger.
- Watch for branches or other hazards that could enter vehicle.

Operation of this vehicle by children age 10 and under increases the risk of severe injury or death. Adult supervision required for children under age 10.

**NEVER permit children age 10 and under to operate or ride in this vehicle.**

LOCATE AND READ OWNER’S MANUAL. FOLLOW ALL INSTRUCTIONS AND WARNINGS. IF OWNER’S MANUAL IS MISSING, CONTACT A YOURS DEALER FOR A REPLACEMENT.

## YOUR WARRANTY RIGHTS AND OBLIGATIONS

The U.S. Environmental Protection Agency and **SSR Motorsports Inc.** are pleased to explain the emission control system warranty on your Off-Road Vehicle. SSR Motorsports Inc. must warrant the emission control system on your vehicle for 5,000 km, or at least 30 months, whichever comes first, provided that there has been no abuse, neglect or improper maintenance of your vehicle. This off-road vehicle was designed to meet the emission standards for 10,000 km, or five years, whichever comes first.

Your emission control system may include parts such as the carburetor or fuel injection system, the ignition system, catalytic converter and engine computer, if it is equipped. Also included may be hoses, belts, connectors and other emission-related assemblies.

Where a warrantable condition exists, SSR Motorsports Inc. will repair your vehicle at no cost to you, including diagnosis, parts and labor.

If an emission-related part on your vehicle is defective, the part will be repaired or replaced by SSR Motorsports Inc. This is your emission control system DEFECTS WARRANTY.

**NOTICE!** Use of any SSR brand vehicle in any type of competitive event completely and absolutely voids this and all other warranties offered by SSR Motorsports Inc.

### OWNER'S WARRANTY RESPONSIBILITIES

As the vehicle owner, you are responsible for the performance of the required maintenance listed in your owner's manual. SSR Motorsports Inc. recommends that you retain all receipts covering maintenance on your vehicle, but SSR Motorsports can deny warranty solely for the lack of receipts or for your failure to ensure the performance of all scheduled maintenance.

You are responsible for presenting your vehicle to the SSR Motorsports Inc. dealer as soon as a problem exists. The warranty repairs should be completed in a reasonable amount of time, not to exceed 30 days.

As the vehicle owner, you should be aware that SSR Motorsports Inc. may deny your warranty coverage if your vehicle or a part has failed due to abuse, neglect, improper maintenance or unapproved modifications.

If you use your vehicle in any type of competitive event, this warranty is immediately and completely void.

If you have any questions regarding your warranty rights and responsibilities, you should contact your nearest SSR Motorsports authorized dealership using our dealer locator found here:

[http://www.ssrmotorsports.com/store/dealer\\_locator.php](http://www.ssrmotorsports.com/store/dealer_locator.php), or the U.S. Environmental Protection Agency at 2000 Traverwood Drive, Ann Arbor, MI 48105.

### YOUR WARRANTY RIGHTS AND OBLIGATIONS

SSR Motorsports Inc. warrant that each new SSR branded off-road vehicle:

**A.** Is designed, built and equipped so as to conform at the time of initial retail purchase with all applicable regulations of the United States Environmental Protection Agency; and

**B.** Is free from defects in material and workmanship which cause such vehicle to fail to conform to applicable regulations of the United States Environmental Protection Agency for the periods specified above.

I. **Coverage.** Warranty defects shall be remedied during customary business hours at any authorized SSR Motorsports Inc. dealer located within the United States of America in compliance with the Clean Air Act and applicable regulations of the United States Environmental Protection Agency. Any part or parts replaced under this warranty shall become the property of SSR Motorsports Inc.

**II. Limitations** This Emission Control System Warranty shall not cover any of the following:

**A.** Repair or replacement as a result of

- (1) accident,
- (2) misuse,
- (3) repairs improperly performed or replacements improperly installed,
- (4) use of replacement parts or accessories not conforming to specifications set forth by SSR Motorsports Inc., which adversely affect performance and/or
- (5) use in competitive racing or related events.

**B.** Inspections, replacement of parts and other services and adjustments required for required maintenance.

**C.** Any vehicle equipped with an odometer or hour meter on which the odometer mileage or hour meter reading has been changed so that actual mileage cannot be readily determined.

**III. Limited Liability**

**A.** The liability of SSR Motorsports Inc. under this Emission Control System Warranty is limited solely to the remedying of defects in material or workmanship by an authorized SSR Motorsports Inc. dealer at its place of business during customary business hours. This warranty does not cover inconvenience or loss of use of the vehicle or transportation of the vehicle to or from the SSR Motorsports Inc. dealer. SSR Motorsports Inc. shall not be liable for any other expenses, loss or damage, whether direct, incidental, consequential or exemplary arising in connection with the sale or use of or inability to use the SSR branded vehicle for any purpose. Some states do not allow the exclusion or limitation of any incidental or consequential damages, so the above limitations may not apply to you.

**B.** No express emission control system warranty is given by SSR Motorsports Inc., except as specifically set forth herein. Any emission control system warranty implied by law, including any warranty of merchantability or fitness for a particular purpose, is limited to the express emission control system warranty terms stated in this warranty. The foregoing statements of warranty are exclusive and in lieu of all other remedies. Some states do not allow limitations on how long an implied warranty lasts, so the above limitations may not apply to you.

**C.** No dealer is authorized to modify this Limited Emission Control System Warranty issued by SSR Motorsports Inc.

**IV. LEGAL RIGHTS.** This warranty gives you specific legal rights, and you may also have other rights which vary from state to state.

**V.** This warranty is in addition to the SSR Motorsports Inc. limited vehicle warranty.

**VI. ADDITIONAL INFORMATION.** Any replacement part that is equivalent in performance and durability may be used in the performance of any maintenance or repairs. However, SSR Motorsports Inc. is not liable for these parts. The owner is responsible for the performance of all required maintenance. Such maintenance may be performed at a service establishment or by any qualified individual. The warranty period begins on the date the OFF-ROAD VEHICLE is delivered to an ultimate purchaser.

If you have any questions regarding your warranty rights and responsibilities, you should contact your selling dealer or any authorized SSR Motorsports dealer using our dealer locator:

[http://www.ssrmotorsports.com/store/dealer\\_locator.php](http://www.ssrmotorsports.com/store/dealer_locator.php) or the U.S. Environmental Protection Agency at 2000 Traverwood Drive, Ann Arbor, MI 48105.

**SSR Motorsports Inc.**

12825 Alondra Blvd. Norwalk, CA 90650