



In case you need any Clarification or Service Assistance, please contact our Dealer

Dealer code , name

Address

.....

.....

Contact person name and mobile no. (Sales)

.....

Contact person name and mobile no. (Service)

.....

Email id

Or

TVS Motor Company's Area Offices (flip over for addresses)

Or

Toll Free Number : 18004252077

Email : Service.Support@tvsmotor.com

CONTACT(S) FOR SUPPORT

CONTACT AT OUR AREA OFFICES

TAMILNADU-1

1. TVS Motor Company Limited

SPL - Sriram Nivas, 1st Floor,
No. 38, Venkatakrishna Road,
Mandaveli, Chennai - 600 028.
Phone : 044-24951652/24950018
Email : AO.Chennai@tvsomotor.com

TAMILNADU-2

2. TVS Motor Company Limited

No.10, 2nd floor,
Shree Shanmugapriya Towers,
Kannuswamy Street,
Behind Hotel Annapoorna,
R S Puram, Coimbatore - 641 002.
Phone : 0422-4350060/2541035
Email : AO.Coimbatore@tvsomotor.com

TAMILNADU-3

3. TVS Motor Company Limited

D-09, Srinidhi Block, Agrini Apartments,
Andalpuram, TPK Road,
Madurai - 625 003.
Phone : 0452-4208690
Email : AO.Madurai@tvsomotor.com

TAMILNADU-4 & PONDICHERRY

4. TVS Motor Company Limited

No. 37, 1st Floor,
West Brindavanam,
Near Le Royal Park Hotel,
Puducherry - 605 013.
Email : AO.Pondicherry@tvsomotor.com

KERALA

5. TVS Motor Company Limited

Ambady Towers, Second Floor,
Door No. 27/631, A6,
Edappally-Pookkattupady Road,
Edappally PO., Cochin - 682 024.
Phone : 0484-2544578/2556938
Email : AO.Cochin@tvsomotor.com

ANDHRA PRADESH-1

6. TVS Motor Company Limited

D-19, 302-3rd floor, Gayathri Arcade,
Vikrampuri, Secunderabad - 500 003.
Phone : 040-27840590/27844419
Email : AO.Hyderabad@tvsomotor.com

ANDHRA PRADESH-2

7. TVS Motor Company Limited

Door No. 58-2-35, NCK Plaza,
NTR Circle, Patamata,
Vijayawada - 520 010.
Phone : 0866-6575100
Email : AO.Vijayawada@tvsomotor.com

KARNATAKA-1

8. TVS Motor Company Limited

#600, Anand Surya, 2nd Floor, 5th Cross,
6th Phase, JP Nagar, BMTA Stop,
Bangalore - 560 078.
Phone : 080-42455000/25118000
Email : AO.Bangalore@tvsomotor.com

KARNATAKA-2 & GOA

9. TVS Motor Company Limited

BDP Plaza, 3rd floor, New Cotton Market,
Karnataka Bank Road, Hubli - 580 029.
Phone : 0836-4250617/4250618
Email : AO.Hubli@tvsomotor.com

CONTACT(S) FOR SUPPORT



CONTACT AT OUR AREA OFFICES

MAHARASHTRA-1 & 2

10. TVS Motor Company Limited

#401, 4th floor,
The Chambers, Plot No. 4/12/3,
Near Ganpati Chowk,
Viman Nagar, Pune - 411 014.
Email : Service.pune@tvsmotor.com

MAHARASHTRA-3

11. TVS Motor Company Limited

Plot No. 206, House No. 241,
Ward No. 73, 1st floor,
West High Court Road,
Dharampeth, Nagpur - 400 010.
Phone : 0712-2569932
Email : AO.Raipur@tvsmotor.com
Service.Nagpur@tvsmotor.com

CHATTISGARH

12. TVS Motor Company Limited

Magneto the Mall, Offizo 6th floor,
Office No. 627-628, Labhandi,
GE Road, Raipur - 492 010.
Phone : 0771-4260006
Email : AO.Raipur@tvsmotor.com

MADHYA PRADESH-1

13. TVS Motor Company Limited

211-212, 2nd floor,
Chinar Incube Business centre,
Chinar Fortune City,
Near Brindavan Dhaba,
Hoshangabad Road, Bhopal - 462 026.
Phone : 0755-2499406/2499306
Email : AO.Bhopal@tvsmotor.com

MADHYA PRADESH-2

14. TVS Motor Company Limited

301, 3rd floor,
Shagun Arcade, Vijay Nagar,
Indore - 452 010.
Phone : 9826388896
Email : AO.Indore@tvsmotor.com

GUJARAT

15. TVS Motor Company Limited

109, Ayana Complex,
Opp : Suvarna Villa Bungalows,
100 ft Thaltej Hebatpur road,
Off : S.G. highway, Thaltej,
Ahmedabad - 380 054.
Phone : 079-65443748
Email : AO.Ahmedabad@tvsmotor.com

UTTAR PRADESH-EAST & CENTRAL

16. TVS Motor Company Limited

1st floor, Cyber Tower, TC-34/V-2,
Vibhuti Khand, Gomti Nagar,
Lucknow - 226 010.
Phone : 0522-4918300
Email : AO.Upe@tvsmotor.com
AO.upc@tvsmotor.com

UTTAR PRADESH-WEST & UTTARAKHAND

17. TVS Motor Company Limited

K-23, 1st floor, Lajpat nagar, Part II,
New Delhi - 110 024.
Phone : 011-29834773/29834640
Email : AO.Upw@tvsmotor.com

DELHI & HARYANA

18. TVS Motor Company Limited

K-23, 1st floor, Lajpat nagar, Part II,
New Delhi - 110 024.
Phone : 011-29834773/29834640
Email : AO.Delhi@tvsmotor.com
AO.Haryana@tvsmotor.com

CONTACT(S) FOR SUPPORT



CONTACT AT OUR AREA OFFICES

PUNJAB, HIMACHAL PRADESH, JAMMU & KASHMIR

19. TVS Motor Company Limited

SCF- 10-11, Kalghaidhar Enclave,
Baltana Road, Zirakpur,
District Mohali - 140 603.
Phone : 01762-653477/653480
Email : AO.Chandigarh@tvs motor.com

RAJASTHAN-1

20. TVS Motor Company Limited

Plot No. 16-17,
Top floor of National Motors,
Jhotwara Industrial Area,
Jaipur - 302 012.
Phone : 0141-5150900/5150901
Email : AO.Jaipur@tvs motor.com

RAJASTHAN-2

21. TVS Motor Company Limited

204, 2nd floor,
Daulet Chambers, 4-D,
Sardarpura, Udaipur - 313 004.
Phone : 9001897485
Email : AO.Udaipur@tvs motor.com

BIHAR

22. TVS Motor Company Limited

N-Plaza, Jamal Road,
P.S. Kotwali, Patna - 800 001.
Phone : 0612-2200068/2200069
Email : AO.BNJ@tvs motor.com

JHARKHAND

23. TVS Motor Company Limited

2nd floor, Lucas Building,
Argora Bypass Road,
Ranchi - 834 002.
Phone : 0651-2244715
Email : AO.Ranchi@tvs motor.com

ODISHA

24. TVS Motor Company Limited

#303, 3rd floor,
Creative Plaza, Rasulgarh,
Bhubaneswar - 751 010.
Phone : 0674-2580018/2580019
Email : AO.Bhubaneswar@tvs motor.com

WEST BENGAL

25. TVS Motor Company Limited

9/2, Dover lane, Ground floor,
Gariahat, Kolkata - 700 029.
Phone : 033-24617092/24617096
Email : AO.kolkata@tvs motor.com

NORTH EAST STATES

26. TVS Motor Company Limited

147, Udayan, Ganesh Guri,
Opp. Punjab National Bank,
R G B. Road,
Guwahati - 781 005.
Phone : 0361-2202030/2202031
Email : AO.Guwahati@tvs motor.com

UNIQUE FEATURES OF TVS PHOENIX



FULLY-LOADED STYLE STYLISH TANK SCOOPS

A tank scoop that makes your ride look uber-cool, besides representing modern engineering. The aerodynamic design is another stylish new feature in your TVS Phoenix 125.



MUSCULAR FRONT VISOR

We perfected the art of making a first impression and added that to the TVS Phoenix 125. For Starters, the majestic visor does that for you, wherever you go.



PREMIUM 3D LOGO

Yes, the 3D logo stylishly doubles up the look of the bike. The proof of which lies in the number of heads that turn every time you take it out for a ride.



TWIN LED PILOT LAMPS

Apart from complementing the elegant looks of the TVS Phoenix 125, these LED lamps announce your arrival in signature TVS fashion. A brilliant feature, if you ask us.



FULLY-LOADED PERFORMANCE 125CC ECOTHRUST ENGINE

Tailor made to belt out maximum power with minimum consumption. Turn the key. Ignite. And feel the engine come alive. All of 11 PS in it. And you get a whopping mileage out of it.



GAS CHARGED SERIES SPRING SUSPENSION

TVS Phoenix 125 is specially designed for the Indian roads. State-of-the-art MIG (Monotube Inverted Gas Filled) shock absorbers make sure that you don't have to worry about those pesky bumps or pot holes (refer page no. 39 for details).



UNIQUE FEATURES OF TVS PHOENIX



ROTO PETAL DISC BRAKE*

Prevention is better than cure. The thinking behind the disc brakes that allow instant stopping in any situation. In case of the worst, you'll have the best at your disposal (refer page no. 39 for details).



TUBELESS TYRES*

Safety first. Tubeless tyres make sure there is no sudden loss in air pressure at any speed. You can easily reach the nearest service station or home. Simply put, stop only when you want (refer page no. 43 for details).



FULLY-LOADED FEATURES

HAZARD LAMPS

Fog, rain, sleet, mist. Be seen in every scenario. Your TVS Phoenix 125 is equipped with hazard lamps that keep you visible, every single time (refer page no. 19 for details).



FULLY DIGITAL SPEEDOMETER

Special care has been given even to the tiniest of detail. Easy to read digital tachometer with a sporty white backlit display. It even warns you to low battery levels, reminds you to timely service the bike and keep it in perfect running condition. Think of it as the best companion on the road (refer page no. 13 for details).



VEHICLE LOCATION ASSISTANCE*

On the road outside your home or a crowded parking lot, there is one thing that will come easily. Your TVS Phoenix 125. One flick at the key and the bike blinks at you, making it easy to spot it amongst the other. Of course, the looks do the same thing as well (refer page no. 11 for details).



* Applicable only for Disc version

UNIQUE FEATURES OF TVS PHOENIX



COMPOUND PADDED SEATS

Some journeys call for long rides. And long rides call for unparalleled comfort. So, we installed compound padded seating which ensures the most relaxed ride.



SOFT TEXTURED GRIPS

Short round in the city or a trip to the hills on the weekend; to leave the hustle bustle of city behind. It shouldn't take a toll on your hands. Rest assured, it won't.



SOFT TOUCH SWITCHGEAR

Riding should make you feel at home and feel less like an effort. Which is why you'll find all necessary controls at your fingertips. All thanks to the soft touch switchgear in your new TVS Phoenix 125.



DC HEAD LAMP

Like a crown on a masterpiece, it sits stop and lights up your ride. With a flicker-free constant beam headlamp, every single ride is a blessing on the roads. Furthermore, with a nifty pass-by switch operation for day and night.



Dear friend,

Thank you for choosing TVS Phoenix 125 – The Fully Loaded 125cc Bike.

As an elite owner of the TVS Phoenix 125, you are now part of a family with millions of satisfied TVS customers.

TVS Phoenix 125 is a supreme combination of contemporary styling, thoughtful engineering and premium features. It is a re-imagination of comfort and convenience like no other bike in the category.

This manual explains the multiple features and operations of your TVS Phoenix 125. Please read it carefully and follow the instructions to enjoy a fabulous ride.

To prolong your ride, we urge you to get your TVS Phoenix 125 serviced only at TVS Motor Company Authorised Main Dealers / Authorised Dealers.

Wishing you a joyful riding experience!

TVS MOTOR COMPANY LIMITED

This manual should be considered as a permanent part of the motorcycle and should remain with the motorcycle when resold or transferred to a new owner.

All information, illustrations, photographs and specifications contained in this owner's manual are based on the latest product information available at the time of this publication. TVS Motor Company Limited may, however, incorporate modifications or improvements on its vehicles at any time without notice, and therefore, in such events it is possible that the relevant part of the owner's manual does not apply to your vehicle.

Prior permission of TVS Motor Company Limited is required for quoting, copying or reproducing any part of this owner's manual.

 **Note**

Accessories shown in the picture may not be part of the standard equipment.

Pictures shown in this manual are of TVS Phoenix 125 Disc Brake model

Operating this vehicle safely is an important responsibility of the rider. To help you make decisions about safety, we have provided operating procedure and other information in this manual. This information alerts you on potential hazards that could hurt you or others. Since it is not possible to warn you about all hazards associated with operating or maintaining the vehicle, you must use your own judgement.

You will find important safety information in following form in this manual. These words carry the following connotations:

 Warning

*Disregarding this message might result in **injury to the rider.***

 Caution

*This message indicates special procedures or precautions to be followed to **avoid damage to the vehicle.***

 Note

*This message provides further clarification for **clear understanding of a particular information.***

Running-in information	01
Safe riding tips	02
Know your TVS Phoenix 125	06
Riding your TVS Phoenix 125	25
Maintenance	30
Warranty and services	50
Technical specifications	62
General information	65

The first 1000 km is a crucial part for the life of your motorcycle. Proper running-in operation during this period helps in ensuring **maximum life** and **smooth performance** of your motorcycle.

The reliability and performance of your motorcycle depends on the special care and restraint exercised during the running-in period. It is especially important that you avoid operating the engine in high speed (RPM), which could expose the engine parts to excessive stress. Maximum recommended speed during the running-in is:

Maximum 50 kmph speed upto 1000 km (vary the engine speed for better mating of parts).

The first free service at 500 ~ 750 km is most important. During running-in period all the engine components and other parts will have set in. All adjustments to be restored, all fasteners to be tightened. Engine cum transmission oil to be replaced. Timely performance of the first free service will ensure optimum service life and performance from the engine.



Caution

Replacing the engine cum transmission oil during first free service is most important for better life of engine. Always use TVS TRU4 PREMIUM oil (SAE10W30 API-SL, JASO MA2) for better performance and life.

SAFE RIDING RECOMMENDATIONS

Any two wheeler riding requires some precautions to be taken to ensure the safety of the rider, pillion and other road users. These precautions are:

Familiarise yourself with TVS Phoenix 125

Riding skill and your mechanical knowledge form the foundation of safe riding practices. We suggest you to practice riding TVS Phoenix 125 in a low-traffic condition until you are thoroughly familiar with your vehicle and its controls. Remember practice makes you perfect.

Riding apparel

Loose, fancy clothing can be uncomfortable and unsafe when riding a two-wheeler. Choose good quality two wheeler riding apparel.

Know your limits

Ride within the boundaries of your own skill at all times. Knowing these limits and staying within them will help you avoid accidents.



Warning

Two wheeler safety equipment starts with a safety helmet of good quality. One of the most serious injuries that can happen is head injury. Always wear ISI approved helmet. You should also have good suitable eye protection.

SAFE RIDING TIPS



Posture

Proper vehicle riding starts with proper posture.

1. Keep your elbows relaxed and flexible.
2. Sit and adjust yourself on seat so that arms and shoulders are relaxed.
3. Look widely instead of gazing at one point.
4. Keep the knees close to fuel tank.

Cornering

When cornering, centrifugal force works in a direction perpendicular to the direction in which the vehicle is moving. Centrifugal force increases in proportion with speed and the radius of the corner.

During cornering, reduce speed so as to lessen the effects of centrifugal force. By all means, avoid abrupt application of brake or sudden steering.



Warning

One-hand riding is dangerous. Keep both hands firmly on the handle bar and both feet securely on the foot rest. Under no circumstances should both the hands be removed from the handle bar, as it is very dangerous.

Avoid use of mobile phones while riding as it could lead to fatal accident.

Do not downshift the gear in the midst of cornering. Slow down to a safe speed before negotiating a corner. If this is the first time that you are riding a vehicle of this type, we suggest that you practice on a safe, open area to become thoroughly familiar with the operation of the vehicle.

Braking

For safe riding, it is very important to master the braking techniques.

1. Close / release the throttle.
2. Hold the vehicle upright as you apply the brake.
3. Progressive application of brake is safer.
4. Never depress the clutch lever while braking at higher speeds.
5. **Apply both the brakes.**
6. Riding down hills, while cornering and wet roads, close the throttle and down shift the gear to take advantage of gearbox and engine which acts as an additional brake. This will avoid loss of control over the vehicle due to over speed.

Causes for poor braking

1. If the brake shoes / pads or drum / disc are worn out or if there is water or oil on them, sufficient friction does not develop and brakes do not work well.

2. Even when the brake works normally, if the road surface is wet or the tyre surface is worn-out, tyres do not take a firm hold on the surface, increasing the stopping distance.
3. Approximately 60% braking effect is from front brake. **Non-usage of front brake causes poor braking.**



Warning

As the vehicle speed increases, the stopping distance also increases progressively. Be sure that, you have sufficient distance between you and the vehicle or obstruction ahead of you.

Avoid directing the water jet directly towards brake drums / disc pads during water wash.

*Using only the front or rear brake is dangerous and can cause skidding and loss of control. **Apply both the brakes together and with great care on a wet road or other slippery surfaces.** Any abrupt braking on slippery or irregular roads can cause loss of rider control.*

SAFE RIDING TIPS

ACCESSORY INSTALLATION AND SAFETY TIPS

Use extreme caution while selecting and installing the accessories for your motorcycle.

The addition of **unsuitable accessories can lead to unsafe operating conditions**. Your friendly Dealer will assist you in selecting quality accessories and installing them correctly.

While selecting the accessories, make sure the accessories **should not obstruct lighting, steerability, suspension level and ground clearance**. Please ensure that, if the tank cover is used, it is not getting en-trapped between fuel tank and fuel tank cap.

Additional electrical equipments and controls should not exceed the specified electrical system load of the vehicle (capacity of battery and magneto).

EMISSION CONTROL

All the TVS vehicles are tested in the factory for optimum fuel efficiency and lowest possible CO levels.

Do not disturb the Carburettor settings as this may lead to higher fuel consumption and also higher CO levels.

If the vehicle needs any adjustments, please consult nearest TVS Motor Company Authorised Main Dealer or Authorised Dealer.

While adequate care is exercised at the factory to ensure that the emissions are within the limits, it is essential for the owner to always maintain the motorcycle in good condition by getting it periodically checked and serviced by TVS Motor Company Authorised Main Dealer or Authorised Dealer so that the emission and fuel consumption levels are maintained as per norms.



Note

Get your vehicle certified by the Government authorised emission testing stations at specified intervals.

VEHICLE IDENTIFICATION NUMBER

Serial numbers of both frame and engine are required for vehicle identification. They are also required to assist your Dealer for ordering parts or referring to special information.



The frame serial number is stamped on the left side of the steering head tube.

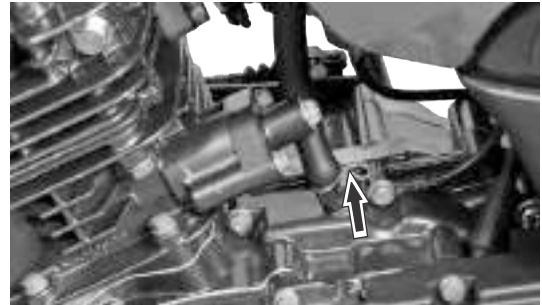

The engine serial number is stamped on the top of the left side crankcase near cylinder block.

Frame number

--	--	--	--	--	--	--	--	--	--	--	--	--	--	--	--	--	--	--	--

Engine number

--	--	--	--	--	--	--	--	--	--	--	--	--	--	--	--	--	--	--	--

Control key number

--	--	--	--	--	--	--	--	--	--	--	--	--	--	--	--	--	--	--	--	--

Please fill the above boxes now for future reference

LOCATION OF PARTS - HANDLE BAR

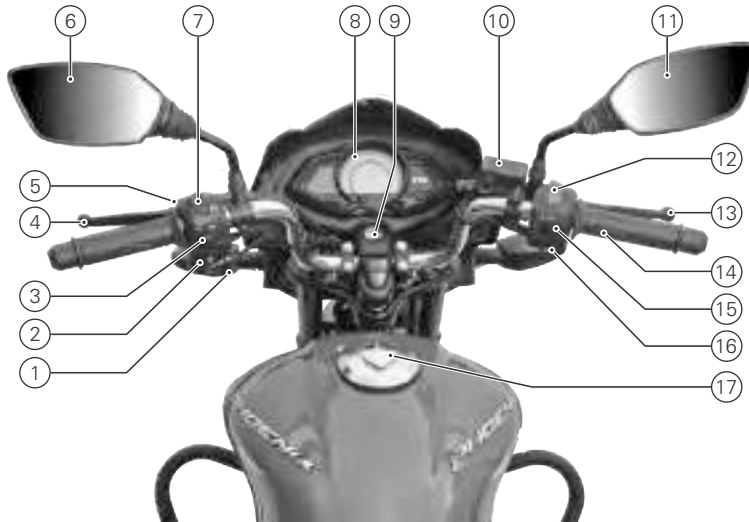

1. Choke lever
2. Horn switch
3. Turn signal lamp switch
4. Clutch lever
5. Pass by switch
6. Rear view mirror L
7. High / low beam switch
8. Digital speedometer
9. Ignition cum steering lock
10. Master cylinder front*
11. Rear view mirror R
12. Hazard switch
13. Front brake lever
14. Throttle grip
15. Head lamp switch
16. Electric starter switch
17. Fuel tank cap

* Applicable only for Disc version

LOCATION OF PARTS - VEHICLE LEFT SIDE

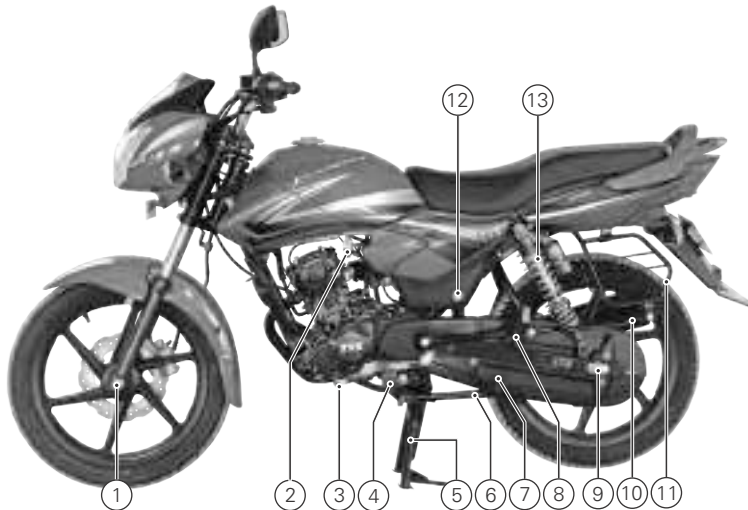

1. Front wheel axle
2. Fuel cock
3. Gear shift lever
4. Rider foot rest L
5. Centre stand
6. Side stand
7. Chain inspection window
8. Pillion foot rest L
9. Rear wheel axle
10. Lady foot rest
11. Saree guard
12. Cover frame L lock
13. Rear shock absorber L

LOCATION OF PARTS - VEHICLE RIGHT SIDE

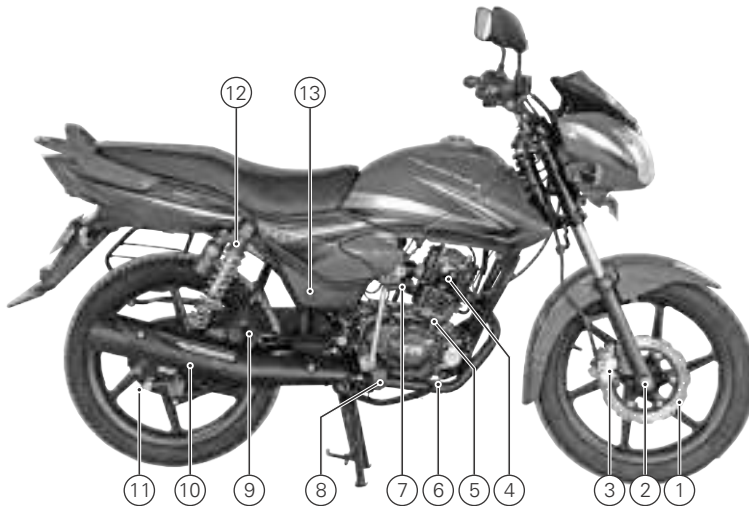

1. Disc plate front*
2. Front wheel axle nut
3. Front caliper assembly*
4. Spark plug
5. Gauge oil level
6. Rear brake pedal
7. Kickstarter lever
8. Rider foot rest R
9. Pillion foot rest R
10. Muffler assembly
11. Rear brake adjuster
12. Rear shock absorber R
13. Cover frame R screw

* Applicable only for Disc version

LOCATION OF PARTS - VEHICLE FRONT AND REAR

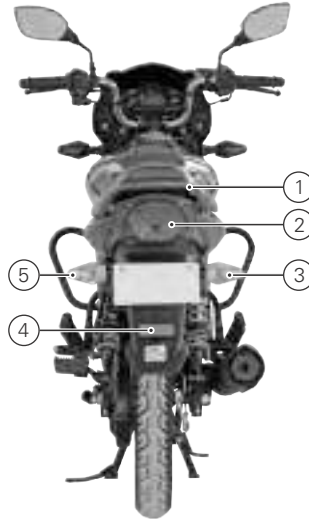
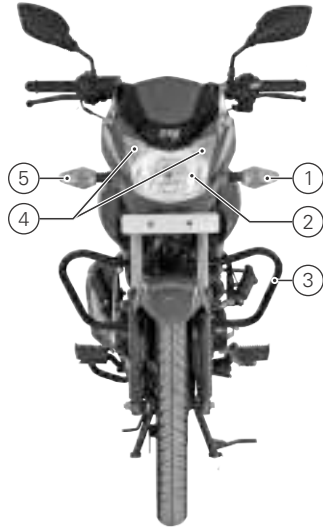

FRONT

1. Turn signal lamp front L
2. Head lamp assembly
3. Crash guard
4. Position lamps
5. Turn signal lamp front R

REAR

1. Pillion handle
2. Tail lamp assembly
3. Turn signal lamp rear R
4. Reflex reflector
5. Turn signal lamp rear L

VEHICLE LOCATION ASSISTANCE*

Your TVS Phoenix 125 comes with a vehicle location assistance device which helps you to find your bike easily when it is parked on the road outside your home or a crowded parking lot. A remote supplied along with your bike for activating vehicle assistance device has an activation switch (A) represented by the (⚡) symbol and an indicator LED (B) on the top.

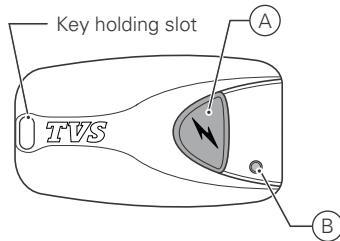

To locate your bike, just press the activation switch of the remote. This makes all the four turn signal indicators of your bike to blink along with the buzzer about 6 times and indicates you the location where it is parked.

Note

Vehicle location assistance works around 15 meter from the vehicle and in-line of sight of the vehicle.

If the vehicle is parked in switched 'OFF' condition for two days, the vehicle location assistance device gets disabled itself to avoid discharge of battery. It gets enabled automatically once the ignition is turned 'ON' again.

While pressing the activation switch of the remote, the LED indicator (B) glows continuously. If it is not glowing, the battery of the remote may lost it's power. Similarly, if the remote is lost / damaged, you can purchase a new remote and assign it with your bike's location assistance device. Contact nearest TVS Motor Company Authorised Main Dealer / Authorised Dealer for battery replacement or for purchasing a new remote and assigning it with your vehicle location assistance device.

* Applicable only for Disc version

Caution

Do not try to assign a non-genuine remote with your vehicle location assistance device. It may damage the device and make it inactive.

Do not attach the remote to your key ring. It may cause rattling noise while driving.

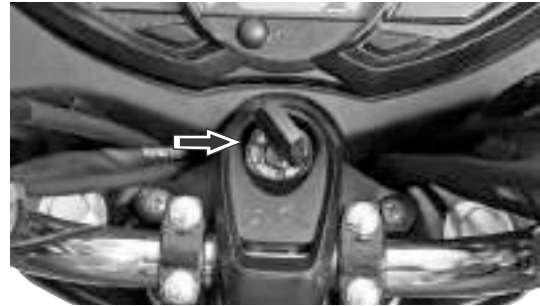

CONTROL KEY

TVS Phoenix 125 comes with a pair of identical control keys. These keys are to operate ignition cum steering lock, fuel tank cap and cover frame R.

IGNITION CUM STEERING LOCK

There are three positions in the ignition cum steering lock. They are:

1. 'OFF' position

All the electrical circuits are turned 'OFF' in this position. Engine will not start. Key can be taken out.

2. 'ON' position

In this position, all the electrical circuits are turned 'ON' and the engine can be started. Key cannot be removed in this position.

3. 'LOCK' position

TVS Phoenix 125 steering can be locked in both 'left' and 'right' directions.

To lock the steering, turn the handle bar all the way to the 'left' or 'right'. Push the key in and turn it to the 'LOCK' position and take out. All the electrical circuits are turned 'OFF' in this position.

Insert the key into the lock and turn it to 'OFF' or 'ON' position to unlock the steering.

Warning

Never attempt to move the vehicle when the steering is locked, you may lose balance.

Caution

Leaving the ignition cum steering lock in 'ON' position will drain the battery when the vehicle is not in use. So "Switch off" and take the key out when the vehicle is not in use. For safety, always lock the steering while parking.

Note

When the ignition lock is turned 'ON' the speedometer performs self test. Wait till the self test cycle of speedometer gets over.

The back light of the speedometer glows continuously once the ignition is turned 'ON'.

DIGITAL SPEEDOMETER

1. Mode switch

Press the switch to change the display mode ('ODO' or 'TRIP').

2. Neutral indicator lamp (N)

Glows when the vehicle is in neutral and goes 'OFF' if the gear is shifted from neutral.

3. Turn / hazard signal indicator

Flashes when the 'left' or 'right' side turn signal indication or hazard signal indication is activated.

4. High beam indicator

Glows when the head lamp high beam is activated.

5. Multi functional digital display





5a. Odometer / trip meter

Odometer registers and displays the total distance covered by the vehicle in kilometers. The digit after the dot mark denotes one tenth of a kilometer. Set the display in 'ODO' mode to know the reading.



Trip meter registers and displays the partial distance covered in kilometers. The digit after the dot mark denotes one tenth of a kilometer.



Set the display in 'TRIP' mode to know the reading. Press the mode switch for a few seconds (in 'TRIP' mode) to reset the trip meter whenever required.

If the 'ODO/TRIP' segments of speedometer are blinking during riding, contact nearest TVS Motor Company Authorised Main Dealer / Authorised Dealer.

5b. Speedo meter

Displays the driving speed in kilometer per hour (km/h) in real time.



5c. Tachometer

Digital bars of tachometer indicates the engine speed in multiples of 1000 rpm (revolutions per minute).

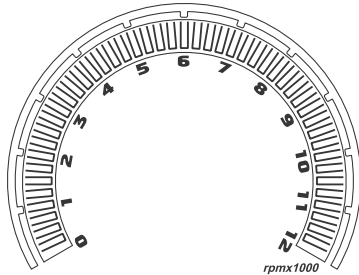

All the eight bars will be displayed when the fuel in the tank reaches above 10.5 liters approximately (full tank). When the fuel reaches half tank (6 liters approx.) the fuel gauge displays only five bars as shown.



The fuel gauge shows only single bar when the fuel reaches reserve level (2.1 liters approx.).

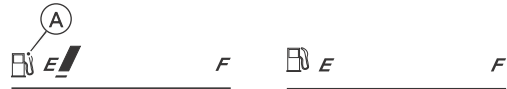

5d. Fuel gauge

Digital bars indicate the approximate fuel quantity available in fuel tank. There are eight bars to indicate the quantity of fuel available in the fuel tank.



Fuel tank symbol (A) starts blinking and one bar will be visible when the fuel reaches to the safe level of approximately 1.5 liters. Refill the fuel immediately. Once the fuel level reaches 1 liter, no bar will be visible and fuel tank symbol (A) glows continuously. **If all the fuel level bars speedometer are blinking, Contact nearest TVS Motor Company Authorised Main Dealer / Authorised Dealer.**

5e. Service reminder

If the service is due, whenever the ignition lock is turned 'ON', an icon with spanner symbol '  ' blinks for 10 seconds after the self test cycle, and continues to glow till the vehicle is serviced and reset. Get the vehicle serviced at TVS Motor Company Authorised Main Dealer / Authorised Dealer.

5f. Low battery indicator

An icon with battery symbol '  ' glows when the battery charge is too low. Get the battery checked at TVS Motor Company Authorised Main Dealer / Authorised Dealer.

 Note

Service reminder indicator lamp works only based on the distance (km) covered by the vehicle. This is only a reminder indicator. Customers are advised to keep track and follow the service schedule.

HANDLE BAR LEFT SIDE

1. Choke lever

Pull the choke lever towards left to apply choke. **During cold start, apply the choke and start the vehicle using electric starter or kick lever without opening / with less opening of throttle.** Once the engine is started and running in stable RPM, release the choke and ride the vehicle.

2. Horn switch

Press the switch '  ' to operate the horn.

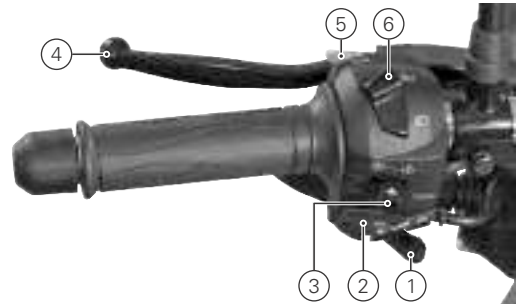

 Caution

Always use choke for starting the cold engine. Never open the throttle fully when the choke is applied. It may lead to flooding of engine and difficulty in starting.

3. Turn signal lamp switch

Slide the turn signal lamp switch to left ' ← ' or right side ' → ' to operate respective turn signal lamps (LH/RH). Press the knob to turn 'OFF'.

4. Clutch lever

Use the clutch lever to disengage the drive to the rear wheel while shifting the gears. Squeezing the lever towards grip disengages the drive.

 Warning

Always use the appropriate turn signal lamps when you intend to change lanes or take turns. Be sure to switch 'OFF' the turn signal lamps after negotiating the turns or lanes.

5. Pass by switch

Press the pass by switch intermittently to signal the opposite vehicle during overtaking. If the switch is pressed during day time, the head lamp high beam flashes. But in night time, if the switch is pressed the head light beam toggles between 'High' and 'Low'.

6. Head lamp high / low beam switch

With the head lamp switch in 'ON' condition, press the beam control switch towards ' ≡D ' to turn-on the head lamp high beam. Press the switch towards ' ≡D ' to turn-on the head lamp low beam.

 Warning

Use appropriate head lamp beam 'high / low' as per the traffic and road conditions for your safety and to avoid inconvenience to other riders.

 Note

If the pass by is operated with the engine 'OFF' condition, the head lamp glows only with 50% illumination.

HANDLE BAR RIGHT SIDE

1. Electric starter switch

Press the electric starter switch '☎' to start the engine electrically with the transmission is in neutral or by depressing the clutch lever when the transmission is in gear.

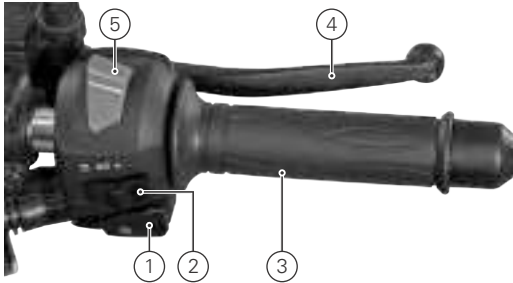

If the electric starter switch is pressed more than 3 sec continuously, the starter motor gets disabled automatically and will not crank the engine. The motor cranks the engine only after 3 sec or if the switch is released and repressed.

Caution

For cold starts, avoid using electric starter. Use kickstarter. A typical example is early morning start. This would reduce load on the battery and prevents quick drain.

2. Head lamp switch

Head lamp switch has three positions. Working of head lamp at various positions are as follows:

OFF: All the lamps are turned 'OFF' (except speedo backlit) when the switch is at '●' position even though the ignition is 'ON'.

PO: Position lamps and tail lamp glows when the switch is at '☒' position with the ignition 'ON'.

ON: Head lamp glows along with the above said lamps when the switch is at '☀' position and engine is running. **If the engine is idling for more than 30 seconds, the head lamp power (brightness) reduces automatically. Once the throttle is operated, the head lamp will be back to normal brightness.**

3. Throttle grip

Engine speed is controlled by the rotation of the throttle grip. Twist it towards you to increase the engine speed and away from you or release it to decrease the engine speed.

4. Front brake lever

The front brake is applied by squeezing the front brake lever gently towards the throttle grip. The brake lamp glows on application of front brake.

5. Hazard switch

Whenever it is necessary to park the motorcycle in a hazardous location due to emergency situation, press the hazard switch away from you with the ignition 'ON' condition. This makes all the turn signal lamps to flash simultaneously to make other road users aware of presence of the vehicle. Press the switch towards you to turn-off the lamps.



Note

Avoid unnecessary usage of hazard warning lamps with engine off condition. Battery may get drained.

FUEL TANK* CAP

To open the fuel tank cap, move away the protection lid (A) from its position. Insert the control key into the lock and turn it in clockwise direction. The tank cap ejects automatically. Take out the cap along with the key.

To close, press the cap back to its original position by keeping the front end (arrow marked) towards the handle bar. Take out the key and close the protection lid.

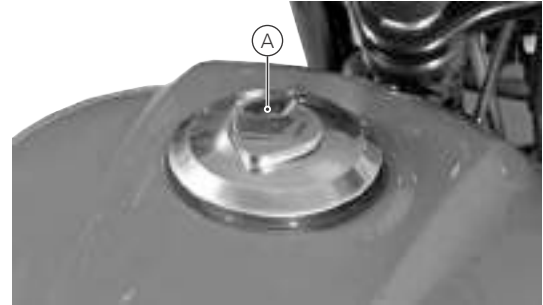

** Fuel tank is not a measuring instrument and capacity of the fuel tank may slightly vary from the indicated capacity.*

Warning

Avoid spilling of fuel on the hot engine. Never refill fuel near open flame. Do not smoke while refueling. Do not use cell phones while refueling.

Note

Whenever refueling the bike, fill upto the bottom of neck portion of the fuel tank. Filling above the neck may result in improper breathing of fuel tank and seepage of fuel.

FUEL COCK

Fuel cock has the following three positions:

- ON: Fuel flows in this position when the fuel is above the reserve level in the tank.
- RES: Switch over the fuel cock lever to this position when the fuel stops flowing in 'ON' position.
- OFF: Fuel flow cuts off from the fuel tank to carburettor.



Caution

Leaving the fuel cock in 'ON' or 'RESERVE' position may cause the fuel tank to completely drain out, in case any malfunctioning of carburettor float system.

Similarly, if the fuel cock is positioned between 'ON' and 'OFF' may drain off entire fuel while riding the vehicle.

KICK STARTER LEVER

The kick starter lever is located on the right side of the vehicle. To start the vehicle, keep the ignition in 'ON' condition and transmission in neutral. Keep your foot on the lever extension and kick from top and stroke to bottom with rapid motion.

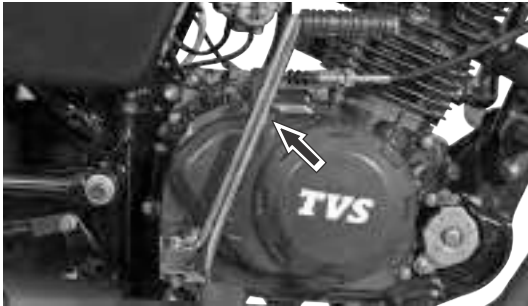

Note

It is recommended to start the vehicle always in neutral gear. However, the vehicle can be started in any gear using electric starter, after depressing the clutch lever.

Please note that the engine can be started with the kickstarter lever only when the vehicle is in neutral.

GEAR SHIFT LEVER

TVS Phoenix 125 has a heel and toe gear shift lever. To shift the gear from neutral to higher, press the rear end of gear shift lever by heel once for each gear after applying the clutch.

Similarly, to down shift to lower gears, press the front end of the lever by toe once for each gear after applying the clutch.

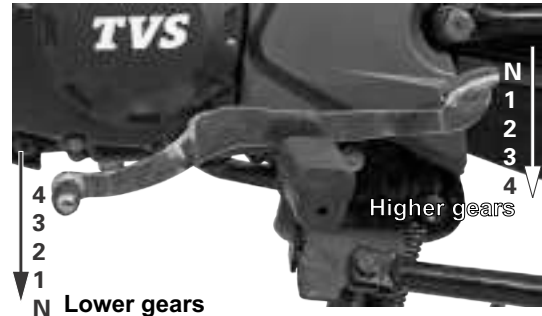

REAR BRAKE PEDAL

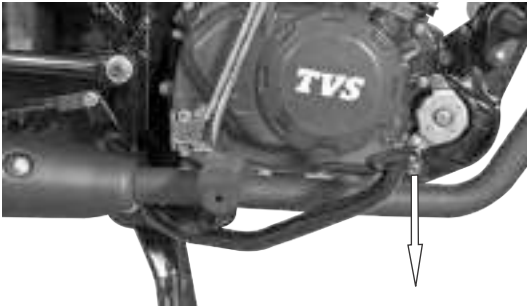

Rear brake pedal is located on the right side of the vehicle. Press the rear brake pedal with your right foot to apply the rear brake. The brake lamp glows on application of brake.

Warning

Brakes are items of personal safety and should always be maintained in proper condition.

STANDS

TVS Phoenix 125 is equipped with a centre (1) and side stand (2). To place the vehicle on the centre stand, hold the handle bar left grip with left hand and pillion handle with right hand. Place your foot firmly on the centre stand extension (1a) and press with adequate effort. Ensure both the legs of centre stand are touching the ground before placing the vehicle on the stand.

Side stand can be operated by sitting on the vehicle with your left foot by pushing it away from the vehicle till it stops.

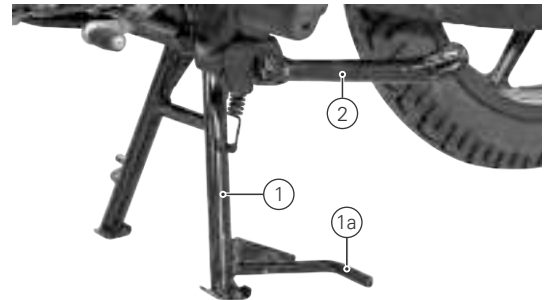

 **Warning**

Always release the side stand to its full up position before moving the vehicle.

 **Caution**

Never sit on the vehicle when it is supported by side stand. Always park the vehicle on a flat, firm surface.

COVER FRAME L

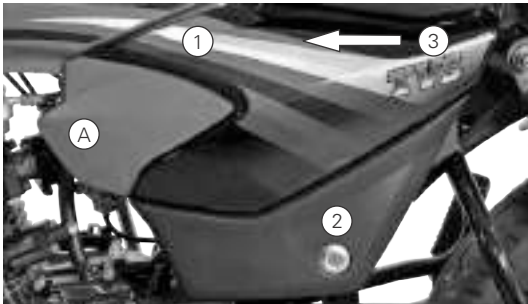

TVS Phoenix 125 is provided with lockable cover frame on the left side for accessing the battery, tool kit and first aid kit. This cover can be opened in the following manner:

1. Insert the control key into the cover frame lock (2) and rotate it in clock wise direction.
2. Take out the cover frame by gently pulling out at front (1) and bottom (2) and sliding it forward.

To assemble the cover frame back

1. Locate the cover frame rear portion carefully into the frame hook at (3) while ensuring the availability of cushion in the hook.
2. Locate the cover frame lug (front) into the fuel tank hole while ensuring the availability of cushion in the hole and gently press.
3. Now lock the cover frame by turning the key in anti-clockwise direction.

 **Caution**

Do not pull out the cover frame by holding the cover frame front at (A) as it may get damaged.

TOOL KIT AND FIRST AID KIT

To assist you in performing certain aspects of periodic maintenance and emergency repairs, a tool kit is supplied along with the vehicle. A first aid kit is also available along with the tool kit.

Both tool kit and first aid kit are located below the cover frame L. Remove the cover frame L as explained earlier to access them.

Tool kit consists of one number each of the following:

1. 16 mm box spanner



2. 22 mm ring spanner
3. Screw driver handle
4. Combination screw driver bit
5. 14x17 mm open end spanner
6. 10x12 mm open end spanner
7. Tool bag

Note

It is recommended to use the tool kit in case of any emergency only. It is always advisable to take your vehicle to TVS Motor Company Authorised Main Dealer / Authorised Dealer.

INSPECTION BEFORE RIDING

Check the following items before riding.

ITEM	WHAT TO CHECK FOR
Engine cum transmission oil	Availability of oil upto the level (page no. 37)
Fuel	Enough fuel for the planned distance of running
Tyres	Correct pressure (page no. 43) Adequate tread depth / No cracks or cuts
Battery	Proper working of position lamps, tail lamp, horn, brake lamp, turn signal lamps, neutral lamp and electric starter. Proper working of pass-by, head lamp high beam / low beam and high beam indicator. Low battery indication (page no. 16) and electrolyte level (page no. 34)
Speedometer	Performing self check and proper working of back illumination
Steering	Smooth movement / No play or looseness
Throttle	Correct free play of cable / Smooth operation
Clutch	Correct free play of cable (page no.37) Smooth and progressive action
Brakes	Availability of brake fluid (incase of disc brake), proper working of brake and correct brake play (page no.39).
Wheels	Free rotation

STARTING THE ENGINE

Turn the fuel cock lever to 'ON' or 'RESERVE' position based on the availability of fuel in the tank. Insert the control key into the ignition cum steering lock and turn it to the 'ON' position. Wait till the self test cycle of speedometer gets over.

Keep the transmission in neutral and press the electric starter switch to start the engine electrically or kick start.

When the engine is cold

- ❑ Pull the choke lever and start the engine using kick starter with no opening / very less opening of throttle.
- ❑ Once the engine is started and running stable, release the choke lever and ride the vehicle (when the engine is warm / hot do not use choke).



Caution

Do not keep the engine in idling rpm for long and do not open excessive throttle when engine is idling and the vehicle is parked. It leads to overheating of engine and damage to the internal components.



Warning

Do not run the engine indoors where little or no ventilation available. Exhaust gases are extremely poisonous.

SETTING THE VEHICLE IN MOTION

1. Depress the clutch lever and engage the first gear by pressing rear end of gear shift lever.
2. Open the throttle slowly and simultaneously release the clutch lever gently and gradually. The vehicle starts moving forward.
3. As the vehicle picks up speed, shift to the next higher gear by closing throttle, applying the clutch and pressing the gear shift lever rear end once again.
4. Release the clutch lever and open the throttle smoothly. Select the required gears in similar manner.

Using the transmission

The transmission is provided to keep the engine to run smoothly in its normal operating speed range. The gear ratios have been carefully chosen to meet the characteristics of the engine.

The rider should always select the most suitable gear to achieve the necessary speed and pulling power smoothly.

Riding on hills / gradients

When climbing steep hills, the motorcycle may begin to slow down and show lack of power. At this point you should shift to a lower gear so that the engine will again be operating in its normal power range. Shift gears rapidly to prevent the motorcycle from losing momentum.

When riding down a hill, the engine may be used as braking by shifting to a lower gear.

STOPPING AND PARKING

1. Close the throttle completely and apply both the brakes simultaneously.
2. Down shift the gears as the road speed decreases. Bring the engine to neutral position just before the vehicle stops.



Warning

Reduce speed to a safe limit before turning / cornering. Do not apply brake while turning / cornering. Do not disengage clutch before braking.

3. Turn the ignition 'OFF'.
4. Park the vehicle on a firm, flat surface.
5. Lock the steering and turn 'OFF' the fuel cock.

FUEL RECOMMENDATION

Use unleaded petrol only.

The petrol should be 85 to 95 octane by research method. Use recommended fuel additives for longer life of engine components and lower maintenance. Petrol mixed with ethanol will have impact on engine components. Contact your TVS Motor Company Authorised Main Dealer / Authorised Dealer for usage.



Caution

Never mix oil in petrol in the fuel tank. Always fill fuel from the reputed and reliable fuel stations.



Note

Use fuel additives in petrol as recommended by the respective manufacturer for low carbon deposition.

CHECKS AND TIPS FOR IMPROVING FUEL ECONOMY

Regular checks

Carry out the periodic maintenance checks as specified in this manual (refer page no. 31 and 32).

Regular maintenance checks will save fuel and ensure trouble-free, enjoyable and safe riding besides keeping environment clean.

Spark plug

A dirty or defective spark plug leads to wastage of fuel due to incomplete combustion. Clean and adjust the spark plug only if necessary. **Replace the spark plug every 12000 kms (1 year). Always use recommended spark plug only.**

Air cleaner element

A dirty air cleaner element restricts airflow and increases the fuel consumption. **Replace the element every 12000 kms.**

Since paper filter is used in your motorcycle it is not recommended to clean the filter. Replace the filter incase of any abnormalities.

Clutch

Increase in engine rpm during acceleration, without a increase in road speed indicates the clutch slip. A slipping clutch will cause high fuel consumption and engine overheat.

If the condition persists even after adjusting the clutch lever play, immediately have the clutch checked by TVS Motor Company Authorised Main Dealer or Authorised Dealer.

Engine cum transmission oil

Dirty or less engine cum transmission oil increases the friction between various parts of engine and reduces the engine life, thereby increases the fuel consumption.

Regularly inspect the engine cum transmission oil for correct level and top-up if necessary. Get it replaced at regular intervals as per the maintenance schedule.



Caution

Never drive the vehicle with half clutch. This will reduce the life of clutch and affects the performance of the vehicle and fuel economy.

Fuel leak

Check and arrest fuel leak if any, from tank, carburettor and fuel lines. Loss of fuel due to leak may drain the fuel tank completely.

Evaporation

Vehicle parked in the hot sun leads to wastage of fuel through evaporation. Also, lower fuel levels in the tank will have increased evaporation and condensation of moisture inside, which may result in rusting of the tank.

Ensure to close fuel tank cap after every filling. If the fuel tank cap kept open for long time, it leads to safety and fuel loss.

Tyres

Low tyre pressure has adverse effects on the vehicle. The **drag on the vehicle** increases resulting decreased fuel economy. Further more, handling may be adversely affected.

Inspect the tyre pressure regularly (weekly) and inflate it to the recommended pressure (refer page no. 43). Never use tyres which are worn beyond the permissible limit.

Chain slackness

Check and ensure the drive chain slackness. Excess slackness leads to higher fuel consumption (refer page no. 45).

Wheel freeness

Check and ensure the wheel freeness by rotating the wheel at least once in a week to avoid wastage of fuel.

Fast starting from rest wastes fuel

A racing start from rest at full throttle can waste fuel and damage the engine. It also creates a potentially dangerous traffic situation.

Fast acceleration wastes fuel

Fuel is wasted whenever you suddenly accelerate or apply brake.

Avoid unnecessary idling

While waiting for someone or stopping in signals for long time, if the engine is kept running at idle speed, it causes unnecessary wastage of fuel.

Avoid frequent braking

Anticipate corners and slopes as well as the traffic conditions. **Unnecessary and frequent braking will reduce the fuel economy.**

MAINTENANCE SCHEDULE

The maintenance schedule indicates the intervals between periodic services. At the end of each interval, be sure to inspect, check, replace, adjust, lubricate and service as instructed. If the maintenance is not done periodically, it will result in rapid wear and severe damage to the vehicle. If the vehicle is used under high stress conditions such as continuous full throttle operation or is used / operated in dusty climate, certain jobs should be performed more often to ensure reliability of the vehicle. Cylinder head, steering components, suspension, chain and wheel components etc., are key items and require very special and careful servicing. TVS Motor Company Limited strongly recommends that the jobs as per the maintenance schedule be performed by your TVS Motor Company Authorised Main Dealer / Authorised Dealer.

Periodic inspections may reveal one or more parts that may need replacement. Whenever replacing parts on TVS Phoenix 125, it is recommended that you use only the **TVS Motor Company Genuine** parts.



Caution

Proper running-in and maintenance are mandatory for making certain that your vehicle is reliable and gives optimum performance at all times. Be sure that the periodic maintenance is performed thoroughly in accordance with the instructions given in this owner's manual.

In more dusty areas, the air filter element may required early replacement than the mentioned kilometers to avoid costly damages to the engine.

PERIODIC MAINTENANCE SCHEDULE

Item	Service km Period from the date of sale	In free service					After free service		Remarks
		1st 500-750 1 month	2nd 2500-3000 3 months	3rd 5000-6000 6 months	4th 8500-9000 9 months	5th 11500-12000 12 months	Every 3000 km	Every 6000 km	
Engine cum transmission oil		R	I & T	R	I & T	R	I & T	R	
Oil filter (strainer)		C	-	C	-	C	-	C	
Centrifugal filter		-	-	C	-	C	-	C	
Spark plug		C & A	-	-	-	R	-	-	Replace every 12000 km
Air cleaner element		-	-	-	-	R	-	-	Replace every 12000 km
SAL filter		-	-	-	-	R	-	-	Replace every 12000 km
PCV filter element		-	-	-	-	R	-	-	Replace every 12000 km
Carburettor assembly		C & A	-	-	-	C & A	-	-	C & A every 12000 km
Tappet clearance		I & A	-	I & A	-	I & A	-	I & A	
Fuel cock sediment bowl		C	C	C	C	C	C	-	
Hose fuel		I	I	I	I	I	I	-	Replace every three years
All control cables ¹		I, A & L	I, A & L	I, A & L	I, A & L	I, A & L	I, A & L	-	
Throttle grip		-	-	L	-	L	-	L	Lubricate using grease
Choke operation		I	I	I	I	I	I	-	
Steering smooth operation / play		I & A	I & A	I & A	I & A	C, L & A	I & A	-	C & L with fresh Bechem premium grade 3 grease every 12000 km
Front fork oil		-	-	-	-	-	-	-	Replace every 18000 km
Front and rear suspension		I	I	I	I	I	I	-	Inspect for proper functioning
All fasteners		I & TI	I & TI	I & TI	I & TI	I & TI	I & TI	-	
Drive chain		C, L & A	C, L & A	C, L & A	C, L & A	C, L & A	C, L & A	-	Adjust if necessary

MAINTENANCE



Item	Service km Period from the date of sale	In free service					After free service		Remarks
		1st 500-750 1 month	2nd 2500-3000 3 months	3rd 5000-6000 6 months	4th 8500-9000 9 months	5th 11500-12000 12 months	Every 3000 km	Every 6000 km	
All bulbs, horn and switches		I	I	I	I	I	I	-	Inspect for proper functioning
Head lamp beam		I & A	I & A	I & A	I & A	I & A	I & A	-	
Battery electrolyte level		I & T	I & T	I & T	I & T	I & T	I & T	-	
Specific gravity and voltage ²		I	I	I	I	I	I	-	
Brake effectiveness / play ³		I & A	I & A	I & A	I & A	I & A	I & A	-	
Brake cams		-	-	C & L	-	C & L	-	C & L	Lubricate using grease
Brake pad wear*		I	I	I	I	I	I	-	Replace if necessary
Brake fluid*		I & T	I & T	I & T	I & T	I & T	I & T	-	Replace every 21000 km
Brake hose*		I	I	I	I	I	I	-	Replace every three years
Master cylinder cups*		-	-	-	-	-	-	-	Replace every 21000 km
Wheel freeness		I	I	I	I	I	I	-	
Tyre pressure at cold condition		I & S	I & S	I & S	I & S	I & S	I & S	-	
Engine idling RPM		I & S	I & S	I & S	I & S	I & S	I & S	-	
Idling CO% ⁴		I & S	-	-	-	-	-	-	
Centre / side stand pivot		L	L	L	L	L	L	-	Lubricate using TRU4 oil
Kick starter pedal pivot		L	L	L	L	L	L	-	Lubricate using TRU4 oil
Swing arm bearings		-	-	-	-	-	-	-	Lubricate using grease every two years

R - Replace; I - Inspect; T - Top up; C - Clean; A - Adjust; L - Lubricate; TI - Tighten; S - Set

¹ Inspect for proper operation and adjust play. Lubricate ends using grease. ² Recharge if necessary

³ Lubricate brake pedal shaft every service using TRU4 oil

⁴ Idling CO% should be set with the help of exhaust gas analyser and tachometer only

* Applicable only for Disc version

RECOMMENDED LUBRICANTS

Application	Qty	Manufacturer	Brand
Engine cum transmission oil	1000 ml	TVS Motor Company	TVS TRU4 PREMIUM oil (SAE 10W30 API-SL, JASO MA2)
Front fork oil	(for GIL make) 155 ± 2 ml / leg (for TOP make) 140 ± 2.5 ml / leg	IOC / Castrol	Teleshockab oil
Disk brake fluid*	-	TVS Girling	DOT 3 / DOT 4
Grease	-	Bharath petroleum IOC Bechem	MP Grease no. 3 Servo Gem no. 3 Bechem premium grade 3
Chain lubricant	-	TVS Motor Company	TRU SPRAY
Fuel additives	As recommended		IFTEX

* Applicable only for Disc version

SELF - MAINTENANCE PROCEDURES BATTERY

Battery is located below the cover frame L. The electrolyte level of the battery must be maintained to avoid damages to the battery. To check the electrolyte level, follow the procedure:

1. Place the vehicle on centre stand on a flat surface and open the cover frame L as explained in page no. 23.
2. Inspect the battery electrolyte level. It should be between the minimum and maximum level.

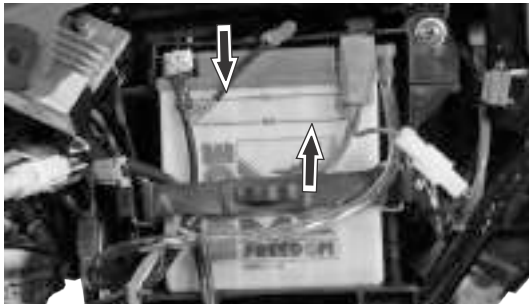

3. If the electrolyte level is below minimum level, add only distilled water upto the maximum level by removing the filler caps.
4. Reinstall the filler caps and clean the battery thoroughly, apply petroleum jelly to the battery terminals to protect it from corrosion.

Incase of any abnormality or for removal of battery from the vehicle, contact TVS Motor Company Authorised Main Dealer or Authorised Dealer.

Caution

Once the battery is charged initially, never add diluted sulphuric acid. Use only distilled water for topping up. Never add tap water.

Never check the battery charge by shorting the terminals. Always connect the positive terminal first and then negative to avoid sparking.

Do not obstruct, bend or change the routing of battery air vent tube. Make sure that the vent tube is firmly attached to the battery and the other end is open and clear.

MAINTENANCE



FUSE REPLACEMENT

Non-working of electrical system may be due to safety fuse failure. Short circuit or overload in the electrical system are the main cause for fuse failure. Two 10A blade type fuses are provided for the safety of your bike's electrical system. One fuse is given exclusively for head lamp and the next one is for other electrical systems. In case of any fuse failure:

1. Open the cover frame L (refer page no. 23) and pull out the fuse case from its location.
2. The fuse cases contains two 10A fuses. Open the fuse case cover and pull out the blown fuse.

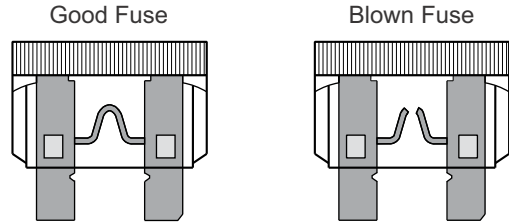
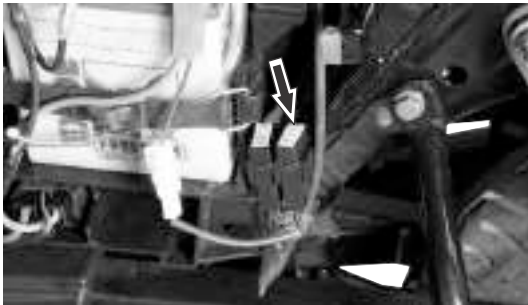

3. Replace the fuse with a new (extra fuse is provided in a pouch in the wiring harness itself). Close the fuse case cover.
4. Turn the ignition 'ON' and check for proper functioning of electrical systems. In case the fuse fails again, consult nearest TVS Motor Company Authorised Main Dealer / Authorised Dealer.

Caution

*Do not use vehicle by **shorting the wires without a fuse**. This may result in overheating of electrical / wiring and may result in fire. **Do not use fuse of higher amperage than specified for the safety of electrical system.***

SPARK PLUG

1. Clean the dust and mud around the spark plug mounting to avoid falling inside the cylinder.
2. Pullout the suppressor cap from spark plug. Using spark plug spanner, remove the spark plug.

A spark plug with heavy carbon deposits will not produce strong sparks. Hence, only if necessary, remove the carbon deposits from the spark plug with a small wire brush or spark plug cleaning tool.

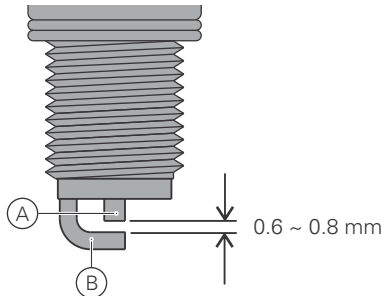

Inspect the spark plug electrodes (A) and (B) for any corrosion. If found any replace the spark plug with a new one.

Inspect the gap of spark plug with a wire gauge / feeler gauge. Readjust the spark plug gap to **0.6 ~ 0.8 mm** if required.

After cleaning and adjusting the gap, reinstall the spark plug and tighten by hand to avoid cross threading. Finally tighten using the spanner. Do not over tight or cross thread the spark plug.

Caution

*Always use only recommended make and type of spark plug. **Replace spark plug every 12000 km.***

Cover the spark plug hole with cloth when the plug is removed to prevent dust/water entry.

It is advisable to tight the new spark plug by hand till the end and then loose and again re-tight the spark plug by 1/8 of rotation after sealing by using only the hand tool .

ENGINE CUM TRANSMISSION OIL LEVEL

Check the engine cum transmission oil level periodically.

1. Place the vehicle on centre stand on a flat surface. Wipe-off the surroundings of gauge oil level.
2. Remove the gauge oil level and wipe it clean.
3. Fix the gauge back to its mounting hole. Do not thread in.
4. Take out the gauge and check the oil level.



5. The oil level should be between the minimum and maximum level marks of the gauge as shown in the figure.
6. If the oil level is less than the minimum level, add TVS TRU4 PREMIUM oil (SAE 10W30 API-SL, JASO MA2) upto the maximum level mark.
7. Wipe out the oil traces with a clean cloth to prevent dust accumulation and assemble back the gauge oil level.



Caution

If the vehicle is driven with less engine cum transmission oil, engine components will be severely damaged. Check the oil level as per the schedule to avoid costly damage. Do not fill excess oil may cause oil leak. Always use TVS TRU4 PREMIUM oil (SAE 10W30 API-SL, JASO MA2) only.

CLUTCH ADJUSTMENT

Clutch lever free play is one of the most important adjustment which you may need to check in-between services for better life of clutch plates.

The free play of the clutch lever should be 10 ~ 15 mm as measured at the clutch lever end before the clutch begins to disengage.

Adjust the clutch lever free play periodically by means of clutch cable adjuster at arm clutch release if the free play is not within the specified limit.

1. Ensure that the engine is cold.
2. Loosen the lock nut (2) while holding the clutch cable adjuster (3). Adjust the clutch cable adjusting nut (1) 'in' or 'out' to give sufficient play in the clutch lever.

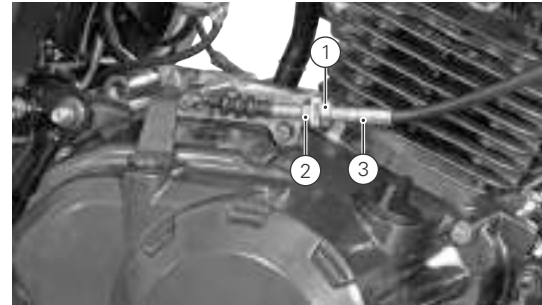
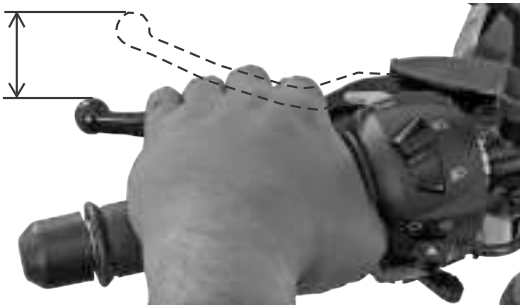

3. After adjusting the play, hold the adjuster nut in the same position, tighten the lock nut.

Caution

Too much or too less clutch lever free play will damage the clutch plates, thereby affecting the performance of the vehicle.

Adjusted clutch lever free play only when the engine is cold.

REAR SHOCK ABSORBERS

TVS Phoenix 125 is provided with adjustable, gas charged, series spring, monotube inverted rear shock absorbers to meet different road and load. There are 5 notches for adjusting spring load. If the spring is adjusted to the minimum notch, then the shock absorber will be softer which is good for light loads. If the spring is adjusted to maximum notch, then it will be stiffer which is good for heavy loads. Adjust the spring pre-load by shifting the adjuster to the required notch according to the different load conditions.

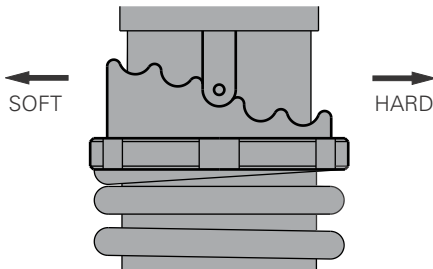

The more you compress the spring, the suspension becomes more stiff.

Caution

Keep both left and right shock absorbers spring adjusters in the same position. Contact nearest TVS Motor Company Authorised Main Dealer or Authorised Dealer for adjusting the shock absorbers.

BRAKES

Front brake (disc type)

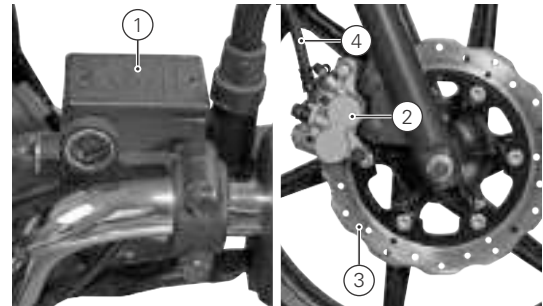

You can observe a master cylinder (1) on the right side of the handle bar, a caliper assembly (2) fitted to the fork leg R, a disc (3) to the front wheel and a high pressure hose (4) connecting the master cylinder and the caliper assembly.

1. Check the master cylinder brake fluid level through the view piece glass (A).
2. Brake fluid level always should be above the 'LOWER' mark (B) provided on the master cylinder when the master cylinder is parallel to the ground.

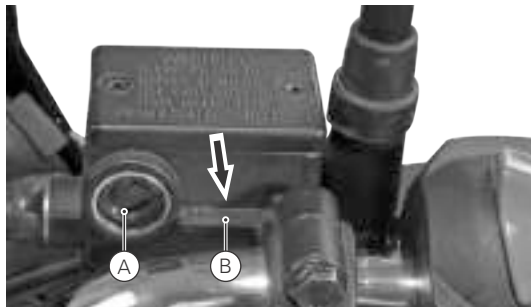

3. If the brake fluid level is below the mark or while applying brake if you feel the brake is more spongy or ineffective due to air entry, contact TVS Motor Company Authorised Main Dealer or Authorised Dealer for topping-up the brake fluid, air bleeding and other brake related inspections.

Brake pad wear indicator

Visually check the brake pads wear. If the wear is found beyond the wear indicator groove as shown in the figure then, replace the brake pads as a set with new one.

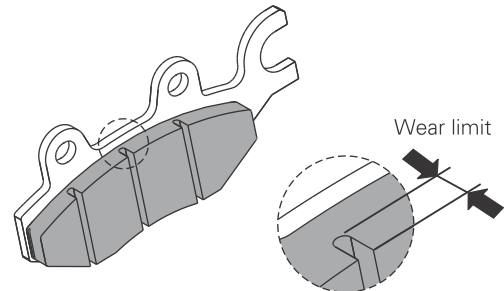

Front brake (drum type)

1. Measure the free play of the front brake lever at the lever end as shown in the figure.
2. The free play of the brake lever before the engagement of brake shall be between 15 ~ 20 mm.

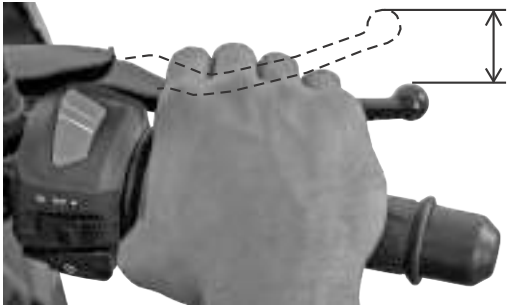

3. If the measured free play is more than the limit, adjust the nut provided at the front wheel end to obtain the correct play.
4. Turn the adjuster nut in clockwise direction for reducing the free play or turn it in anti-clockwise direction for increasing the free play.

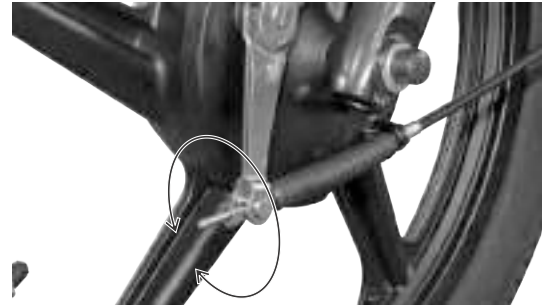

 Warning

Check the brake play periodically. However the brake play needs to be adjusted more frequently depending upon the usage.

5. After adjusting the free play, check and ensure the free rotation of the wheel by rotating the wheel by hand when the vehicle is in center stand.

Rear brake

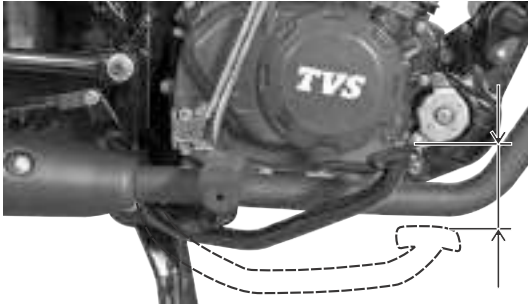

1. Measure the free play of the rear brake pedal at the pedal end as shown in the figure.
2. The free play of the brake pedal before the engagement of brake should be between 15 ~ 20 mm.
3. If the free play is more than the limit, adjust the nut provided at the rear wheel end to obtain the correct play.

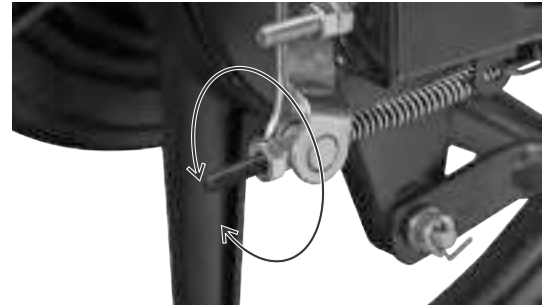

4. Turn the adjuster nut clockwise direction to reduce the free play or turn it in anti-clockwise direction to increase the free play.
5. After adjusting the free play, check and ensure the free rotation of the wheel by rotating the wheel by hand when the vehicle is in center stand.

Brake shoe wear indicator

When the brake is applied, the wear index mark (A) on both front and rear brake cam should be within the range of wear limit indicator (B) on both front and rear brake panel assembly.

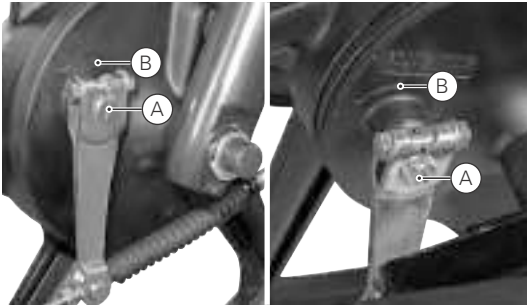

Incase the mark is going beyond the wear limit, index the lever to next slot with the help of Dealer to extend shoe life.

Warning

Replace the brake shoes as a set, if the wear limit indicator shows beyond the wear limit even after indexing the lever.

TYRES

Tyre pressure:

Check the tyre pressure atleast once in a week if not more frequently. Insufficient air pressure in the tyres not only hasten tyre wear, but also seriously affects the stability of the vehicle. **Lower tyre pressure consumes more fuel.**

Under inflated tyres make smooth cornering difficult and over inflated tyres decrease the tyre contact with the ground which can lead to skidding and loss of control. Be sure that the tyre pressure is within the specified limit at all times.

	Solo	Pillion
Front	1.75 kg/cm ² (25 PSI)	1.75 kg/cm ² (25 PSI)
Rear	2.25 kg/cm ² (32 PSI)	2.53 kg/cm ² (36 PSI)

Tyre tread condition

Operating the vehicle with excessively worn tyres will decrease riding stability and can lead to loss of control. It is recommended to replace the tyre when the tyre wears off to the tyre wear indicator level (indicated by TWI on the tyre).



Tyre rotation direction

While reassembling the tyre, after removing from the wheel rim, ensure that the arrow mark (A) on the tyre facing the direction of wheel rotation.

Warning

*Tyre inflation pressure in cold condition and the tyre tread condition are extremely important for the performance and safety of the rider. Check the tyres frequently for inflation pressure as well as the wear pattern on it. **Use of a tyre other than the standard may cause instability.***

Tyre puncture (tubeless tyres)*

Disc version of TVS Phoenix 125 is fitted with a tubeless tyre on both the wheel. In case of any puncture / tyre damage, it is advised to visit the nearest tyre manufacturer Dealer or the tyre shops who knows the repairing method of tubeless tyre. It is not necessary to remove the tyre from wheel rim always to attend a puncture.

Even though, if there is need of tyre removal, it is strongly recommended to use a tyre removal / fitment machine. If at all, the tyre levers needs to be used, the levers should be free from sharp edges. Care should be taken not to damage the tyres and rims.

Caution

The tyre walls of the tubeless tyre which in contact with the wheel rim are only seals the air inside the wheel assembly. Hence care should be taken not to damage the side walls of the tyres during removal/reassembly.

* Applicable only for Disc version

DRIVE CHAIN

Proper lubrication and adjustment of drive chain gives long service life of chain. Poor maintenance of chain causes premature wear or damage to the drive chain and sprockets.

The drive chain must be cleaned, checked, lubricated and adjusted at specified intervals mentioned in the maintenance schedule. **Higher chain slackness consumes more fuel. Uncleaned and dry chain (unlubricated) consumes more fuel.**

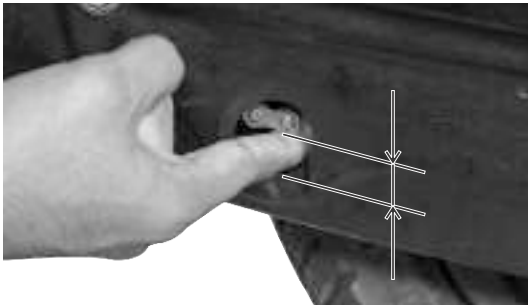

If the vehicle is used under severe conditions and more dusty area, the drive chain must be attended more frequently.

Check, clean, lubricate and adjust the drive chain in the following manner:

1. Place the vehicle on centre stand with the transmission in neutral.
2. Remove the dust seal chain cover.
3. Inspect the drive chain slackness (vertical movement) using the finger as shown in the figure.
4. The slackness of the drive chain should not exceed the limit (20 ~ 30 mm).
5. If the slackness found more, contact TVS Motor Company Authorised Main Dealer / Authorised Dealer for adjustment.
6. If the slackness found is within the limit, lubricate the drive chain using TRU SPRAY / TRU4 oil and re-fix the dust seal chain cover.

FRONT WHEEL REMOVAL AND REASSEMBLY

1. Remove the axle nut (1) along with a washer.
2. Pull out the axle (2) along with a washer.
3. In disc brake model, remove the spacers from both side of the wheel. In drum brake model remove the spacer from right side of the wheel.
4. Place a support below the frame to prevent the vehicle from falling and lift the vehicle up.
5. In drum brake model, dislocate the wheel assembly along with brake panel from the front fork.

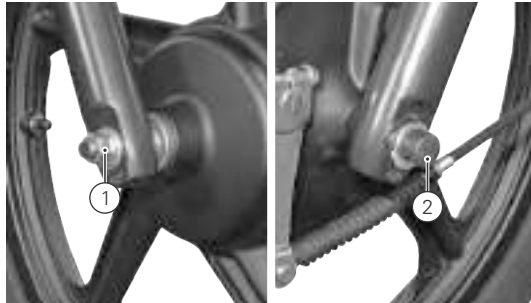

6. Separate the brake panel from the wheel and take out the wheel.
7. In disc brake model, carefully dislocate the disc from the caliper assembly and slide the wheel out.
8. Reverse the procedure for reassembling.

Warning

Always make sure that whenever the wheel is removed, axle nut is properly re-tightened to the specified torque.

In disc brake vehicle, ensure the proper seating of disc in the caliper assembly while reassembling. Similarly, In drum brake vehicle, locate the lug on the fork leg L to the slot in the brake panel while reassembling.

REAR WHEEL REMOVAL AND REASSEMBLY

1. Remove the rear brake adjuster nut (1) and disconnect the brake rod.
2. Remove the split pin (2) and the nut (3) from the torque link mounting with the brake panel and disconnect the torque link.
3. Remove the axle nut (4).
4. Pull out the axle (5) and take out the spacer bush from the rear wheel assembly.
5. Tilt the vehicle to the left and take out the wheel assembly along with the brake panel.

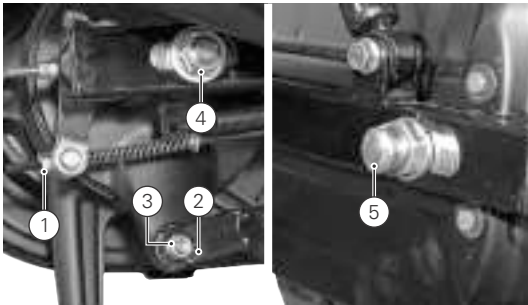

6. Separate the brake panel from the wheel.
7. For locating and reassembling the rear wheel easily, engage the gear. This will arrest the free movement of the drum sprocket.
8. Reverse the procedure for reassembly.

STORAGE PROCEDURES

For storage of your motorcycle for longer period of over a month and above, we recommend to carry out the following steps:

1. Clean the vehicle thoroughly. Park the vehicle on centre stand.
2. Warm up the engine and drain engine cum transmission oil. Store the oil, if new, in a dust free container.
3. Empty the fuel tank. Turn the fuel cock lever to 'OFF' position.
4. Drain the petrol from carburettor.
5. Remove the spark plug and feed in several drops of engine cum transmission oil through spark plug hole. Crank the engine few times and reinstall the spark plug.
6. Remove the battery, store it away from direct sunlight and freezing temperatures.

7. Place a suitable support at the bottom of the frame so that both the tyres are off the ground. This will ensure better tyre life.
8. Cover up the vehicle completely with a clean tarpaulin or any other suitable cover. Store the vehicle inside a garage or similar area to avoid damage due to dust and rain. Make sure that the storage area is well ventilated and free from any source of flame or spark.



Warning

The exhaust system becomes hot after a run. Park the vehicle in a place where pedestrians or children are not likely to touch the vehicle.



Caution

Do not park the vehicle on a slope or soft ground or else it may fall down.

During storage, the battery must be recharged on a constant current battery charger at recommended amperage atleast once in a month.

TAKING THE VEHICLE OUT OF STORAGE FOR REGULAR USE

1. Take the vehicle out of the garage and clean it thoroughly.
2. Remount the battery after bench charging if required.
3. Fill TVS TRU4 PREMIUM oil (SAE 10W30 API-SL, JASO MA2) and check the oil level.
4. Lubricate the parts as instructed in the periodic maintenance schedule.
5. Fill up fresh petrol in the fuel tank.
6. Check and inflate the tyres to the specified tyre pressure.
7. Check and correct the points mentioned in page no. 25.
8. Turn the ignition switch to 'ON' position. Start the engine with choke 'ON' condition for a few minutes and ride out.



Caution

Avoid using alkaline solution like detergent soaps for washing the vehicle. This may damage head lamp and other lamp assemblies.

RECOMMENDED TIPS WHEN TAKING A LONG TRIP OF MORE THAN 500 KM:

- A) Please keep the following items for use in case of emergency:
1. Tool kit complete.
 2. Recommended spark plug one number.
 3. Head lamp and turn signal lamp bulb one each.
 4. Throttle, clutch and front brake cable (incase of drum brake vehicle) one each.
 5. Drive chain lock - one number.
 6. First aid kit.
- B) Precautions to be taken for the journey:
1. Ensure engine cum transmission oil level and brake oil level (only if applicable) are upto the level.
 2. Adequate fuel in fuel tank.
- C) Check your motorcycle for the following:
1. Tightness of all bolts and nuts with correct torque value.
 2. Fitness of tyres / tyre pressure / tread depth.
 3. All bulbs, indicators and horn function.

4. Smooth functioning of all cables and their free play.
5. Smoothness of steering operation.
6. Drive chain and sprocket condition. Chain adjustment.
7. Front / rear brake functioning and rear brake lamp switch adjustment.
8. Front fork for any abnormality.
9. Fuel cock bowl filter cleanliness.
10. Spark plug gap and condition of spark plug.
11. Air filter element cleanliness.
12. Correct idling speed.
13. Lubrication of all items mentioned in the periodic maintenance schedule.
14. Any other job as necessary.
15. Have your vehicle checked at any TVS Motor Company Authorised Main Dealer or Authorised Dealer.



Warning

Long journey are to be taken only after the running-in period of 1000 km.

TVS Motor Company Limited ('the Company') gives this warranty with respect to the TVS Phoenix 125 motorcycle manufactured by the Company.

The Company has taken every care to maintain quality in the manufacture of the TVS Phoenix 125 motorcycle, subject to other terms of warranty:

During 24 months from the date of purchase or during the first 30,000 km of run for the vehicle in the hands of original retail purchaser, whichever is earlier, all parts of the vehicle which prove to the satisfaction of the Company to have a manufacturing defect will be repaired or replaced free of cost.

The Company's obligation under this warranty is limited to repairing or replacing, free of cost, those parts of the vehicle which upon examination by the Company may prove to the Company's satisfaction to have a manufacturing defect, and in such cases the Company's decision either to repair or replace the affected parts will be final. In the event of replacement of parts, the Company also reserves the right to use parts of the same brand as the affected parts or any other brand which is used by the Company in the course of manufacture. All parts replaced under this warranty will become the property of the Company and must be returned to the Company.

Limitations of Warranty:

1. This warranty shall not apply to:
 - Normal maintenance operations such as engine tune-up, decarbonising, fuel system cleaning, oil changes, head light focussing, fastener retightening, adjustments of carburettor, ignition timing, clutch and brakes as well as other normal adjustments.
 - Insignificant factors which do not affect the function of the vehicle, including without limitation, sound, vibration and fluid seep.
 - Replacement of normal service items or wear and tear items, including without limitation, bulbs, electrical wiring, filters, spark plug, chain, sprockets, clutch and brake linings, fasteners, shims, washers, oil seals, gaskets, rubber, plastic and rexine components (including hoses / pipes etc..) disc / pads and spokes etc..

WARRANTY AND SERVICES



- Proprietary parts such as tyres, tubes and battery etc.,.
 - Any natural wear and tear, including without limitation, aging.
 - Parts suffering damage or resultant damage by accident, misuse, negligent treatment, use of bad quality lubricants or impure fuel or by omission to follow the guidance and instructions contained in this owner's manual.
 - Parts which are used in conjunction with parts not made or recommended by the Company.
 - Parts of the vehicle which have been tampered with, altered, repaired or replaced by persons not authorised by the Company and which in the sole judgement of the Company affect the performance of the vehicle.
 - Parts of the vehicle getting affected due to atmospheric effect/environmental factors.
 - Vehicles, on which engine number or chassis number is deleted, defaced or altered.
- **Vehicles on which any warranty (periodic) service is not availed when it falls due.**
 - Vehicles sold or transferred by original retail purchaser.
 - Vehicles used for racing or any competition or used otherwise than for ordinary personal transportation. Vehicles attached with side cars etc..
 - Vehicles which have been taken out of India.
2. Warranty claims on proprietary items such as tyres, tubes and battery etc., should be preferred by the user directly on the respective manufacturer, as per their warranty terms and the Company shall not be liable in any manner in respect to the same.



Warning

Modifications to this vehicle not approved by the TVS Motor Company may cause loss of performance and render it unsafe for use and disqualifies for warranty coverage also.

WARRANTY AND SERVICES



3. Parts repaired or replaced under this warranty are warranted only throughout the remainder of the original warranty period.
4. The Company is not liable for any delay in servicing due to reasons beyond the control of the Company or any of its Authorised Main Dealers / Authorised Dealers.
5. In any event, the Company is not liable for indirect, remote, incidental or consequential damages.
6. The Company may make any modification or improvement to vehicles in future production at any time without prior notice and without any obligation to install the same on vehicles previously despatched for sale.
7. Any claim under this warranty will lie only when the customer:
 - (i) takes his vehicle to an Authorised Main Dealer / Authorised Dealer of the Company and reports the problem he / she felt in the vehicle to enable the Authorised Main Dealer / Authorised Dealer to inspect the same and assess the cause for the reported problems.
 - (ii) produces to such Authorised Main Dealer / Authorised Dealer the owner's manual for the concerned vehicle for verification of relevant details.
8. This is the only warranty given by the Company for the TVS Phoenix 125 motorcycle. No employee, Dealer or other person is authorised to extend or enlarge this warranty.

Customer's Name and address

.....

Frame number.....

.....

Engine number.....

.....

Key number.....

Service coupon no.....

Colour.....

Date of sale.....

Km.....

Registration number.....

.....

Selling dealer's code, name, address and
 phone number:

.....

SERVICE INFORMATION

There are eleven services for TVS Phoenix 125 during warranty period. Of these, the first five are free services for which labour charges are free. In addition to these five free services, we have a scheme of six pay services. Coupons for the free services are attached with this owner's manual. For keeping maintenance track of your vehicle, a pay service record sheet is also attached. Please have the record sheet filled by the Dealer who is carrying out the maintenance service.

Before you avail your first free service, please enter the particulars of your vehicle on the left side of this page. This will be useful for any reference.

For availing any of the eleven warranty services, please take your vehicle and your owner's manual to any of our Authorised Main Dealer or any of our Authorised Dealer. After effecting the service the Authorised Main Dealer or the Authorised Dealer will take out the detachable portion of the relevant service coupon from your owner's manual for their records and will obtain your acknowledgment on the same for having the service done to your satisfaction. For your record, the Authorised Main Dealer or the Authorised Dealer will affix their stamp on the stub of the relevant service coupon or the last column of the record sheet whenever they carry out any service.

WARRANTY AND SERVICES



Periodic maintenance always helps good performance of an automobile and our services are planned to keep your TVS Phoenix 125 performing good. **Please note that carrying out the services for your vehicle at scheduled intervals is necessary for availing of warranty.** And please also remember that, after the services are over, periodic servicing of your vehicle at appropriate intervals, depending upon its extent of use, will keep your vehicle at its best level of performance.

In case you need any clarification or assistance, please feel free to write to us mentioning the frame number, engine number and the date of purchase of your vehicle also the name and place of the Authorised Main Dealer / Authorised Dealer from whom you bought the vehicle and getting it serviced.

Service Department
TVS MOTOR COMPANY LIMITED
P.O.Box No. 4, Harita, Hosur - 635 109,
TAMILNADU, INDIA.
Toll free no. :- 18004252077

TVS
PHOENIX 125

PART (B) DELIVERY CERTIFICATE

(To be given by the customer to TVS Motor Company authorised dealer at the time of taking possession of new vehicle)

<p>Certified that I have taken possession of the TVS Phoenix 125 bearing engine no. and frame no. as mentioned along side from M/s</p> <p>..... today in good condition.</p> <p>I have understood operations, controls and general maintenance instructions including rear wheel removal and engine oil specifications. The terms of warranty have been explained to me and I agree to abide by the same.</p> <p>I have also received the following items along with my TVS Phoenix 125 without extra charge.</p> <ul style="list-style-type: none"> <input type="checkbox"/> Tool kit and first aid kit <input type="checkbox"/> Mirror (2 nos) <input type="checkbox"/> Owners manual <input type="checkbox"/> Set of two keys <p>The location of the tool kit in the vehicle has been shown to me..</p>	<p>TO BE FILLED IN BY THE DEALER</p> <p>Engine No. : <input style="width: 100%;" type="text"/></p> <p>Frame No. : <input style="width: 100%;" type="text"/></p> <p>Dealer code : <input style="width: 80%;" type="text"/></p> <p>Dealer stamp : _____</p> <p>Date of delivery : <input style="width: 100%;" type="text"/></p> <p>Colour : <input style="width: 100%;" type="text"/></p> <p>Mode of purchase by customer</p> <ul style="list-style-type: none"> <input type="checkbox"/> Show room - cash sales <input type="checkbox"/> Show room - hire purchase sales <input type="checkbox"/> Institutional sales <p>Dealer to get the Customer information coupon filled by the customer and hand it over to Market Research, TVS Motor Company Limited, Hosur.</p>	
Dealer's signature :	Customer signature :	Date :

WARRANTY AND SERVICES

भाग (ब) डिलिवरी प्रमाण पत्र

(उपभोक्ता के द्वारा TVS Phoenix 125 अधिग्रहण करने के समय टी.वी.एस डीलर को प्रेषित किया जाये)

प्रमाणित कि मैंने TVS Phoenix 125 का अधिग्रहण उचित अवस्था में मेसर्स

.....

से आज कर लिया है, जिसका फ्रेम नम्बर और इंजन नम्बर साथ में संलग्न है।

मैंने इसके सारे ऑपरेशन, कंट्रो-ल और सामान्य-रख-रखाव के अंतर्गत पिछला पहिया निकालना, इंजन आयल जाँचना इत्यादि का ज्ञान प्राप्त कर लिया है। वॉरंटी के सभी नियम मुझे अवगत हैं, और मैं उनका पालन करने के लिये सहमत हूँ।

TVS Phoenix 125 के साथ बिना किसी अतिरिक्त कीमत के निम्नलिखित वस्तुएँ प्राप्त हुईं.

- टूल किट और प्रथम चिकित्सा किट
- मिरर (२ नं)
- ओनर्स मैनुयल
- एक जोड़ी चाबी

टूल किट का स्थान भी अवगत किया गया है।

डीलर के द्वारा भरा जाये

फ्रेम नं० :

इंजन नं० :

कोड :

डीलर सील :

डिलिवरी की तिथि :

रंग :

वाहन खरीदने का मुख्य प्रारूप.

- शोरूम - नगद
- शोरूम - ऋण सुविधा से।
- इन्स्टिट - युशनल सेल्स

डीलर इस कूपन को उपभोक्ता से भरवा कर टी.वी.एस. सर्विस इंजिनियर को दें।

डीलर हस्ताक्षर :

उपभोक्ता हस्ताक्षर :

तिथि :



Extended Assurance. Guaranteed Smiles.

- ★ Peace of mind for 5 years
- ★ Trouble free ownership experience
- ★ Valid at all India TVSM Authorized network
- ★ TVSM Genuine Parts Guaranteed
- ★ Higher Resale Value of Vehicle.
- ★ Optional feature, can be availed at nominal charges.

Contact your nearest Dealership for details*

*Terms and conditions apply



Drive In.

Drive Out.



**Say bye-bye to waiting time
for servicing your bike.**

Get your vehicle serviced in 1 hour at no additional cost. Contact your nearest Dealership for details.*

*Facility available at selected Dealerships only. Terms and conditions apply



Busy Life? Easy Servicing!

Now, service your bike anywhere, anytime.

- ★ Service the vehicle at your door step.
- ★ Available for regular maintenance or breakdown service only.
- ★ Offered at nominal convenience charges.

Contact your nearest Dealership for details.*

*Facility available at selected Dealership only. Terms and conditions apply



Busy Life? Easy Servicing!

Now, Avail Pickup & Drop of your vehicle for service.

- ★ Vehicle picked up & delivered from/to your office or residence at prefixed appointed time.
- ★ Offered at nominal convenience charges.

Contact your nearest Dealership for details.*

*Facility available at selected Dealership only. Terms and conditions apply

TECHNICAL SPECIFICATIONS



MANUFACTURER : TVS MOTOR COMPANY LIMITED
P.B. No. 4, Harita, Hosur - 635 109, India.

ENGINE

Type : Single cylinder, 4 stroke, air cooled spark ignition engine
Cylinder bore : 57 mm
Stroke : 48.8 mm
Piston displacement : 124.53 cc
Compression ratio : 9.4 : 1.0
Carburettor : UCAL UCD 25
Air filter : Paper filter element
Lubrication system : Positive lubrication
Maximum power in kW : 8.1 (11 bhp) @ 7500 rpm
Maximum torque in Nm : 10.8 @ 5500 rpm
Maximum speed : Around 100 km/hr
Engine idling rpm : 1400 ± 100 rpm (under warm condition)
Starting system : Electric starter /kick starter

TRANSMISSION

Clutch : Wet - Multi plate type
Transmission : 4 speed constant mesh
Gear shift pattern : All up heel-toe shift
Primary transmission : Spur gears
Secondary transmission : Chain and sprockets

GEAR RATIOS

I gear : 3.273
II gear : 1.765
III gear : 1.238
IV gear : 0.958
Primary reduction : 3.250
Final reduction : 3.214

TECHNICAL SPECIFICATIONS

**CHASSIS**

Overall length	: 1985 mm
Overall width	: 740 mm
Overall height	: 1065 mm
Ground clearance	: 165 mm
Wheel base	: 1265 mm
Kerb weight (with toolkit and 90% of fuel)	: 114 kg (drum brake) : 116 kg (disc brake)
Pay load	: 130 kg
Maximum laden weight	: 244 kg (drum brake) : 246 kg (disc brake)
Steering angle	: 88°
Caster angle	: 25°
Frame	: Single cradle tubular frame
Front suspension	: Telescopic oil damped
Rear suspension	: Twin, 5 step adjustable dual spring canister gas shocks with rectangular swing arm.
Trail length	: 65 mm

* Applicable only for Disc version

TYRE

Tyre size	Front	Drum	: 2.75 x 17 (tube type)
		Disc	: 2.75 x 17 (tubeless)*
Rear	Drum	: 90/90 x 17 (tube type)	
	Disc	: 90/90 x 17 (tubeless)*	
Tyre pressure	Front	: 1.75 kg/cm ² (25 PSI)	
	Rear - solo	: 2.25 kg/cm ² (32 PSI)	
	Rear - dual	: 2.53 kg/cm ² (36 PSI)	

BRAKES

Front	: Hand operated, 240 mm dia. disc*
	: Hand operated, internally expanding 130 mm dia. drum
Rear	: Foot operated, internally expanding 130 mm dia. drum

ELECTRICAL

Type	: Fly wheel magneto, AC
Ignition system	: DC - Digital TCI
Spark plug	: BOSCH UR4KC
Spark plug gap	: 0.6 ~ 0.8 mm
Battery type	: 12V, 5.0 Ah (lead acid type)
Generator	: Fly wheel magneto 12V, 130W

TECHNICAL SPECIFICATIONS



ELECTRICAL

Body earthing	: Negative terminal
Head lamp	: 12V, 35/35W x 1
Position lamp	: LED
Tail/brake lamp	: 12V, 5/21W x 1
Turn signal lamp	: 12V, 10W x 4
Instrument panel	: LCD/LED indicators
Horn	: 12V, DC x 1
Main fuse	: 12V, 10A x 1
Head lamp fuse	: 12V, 10A x 1
Vehicle location device remote battery	: 3V, CR2016 x 3 (Lithium)*

CAPACITIES

Fuel tank capacity	: 12.0 liters (including reserve)**
Reserve	: 2.0 liters
Engine cum transmission oil grade	: TVS TRU4 PREMIUM oil (SAE 10W30 API-SL, JASO MA2)
Engine cum transmission oil and capacity	: 1000 ml
Front fork oil grade	: IOC/ Castrol teleshockab oil
Front fork oil capacity	: 155 ± 2 ml per leg (for GIL make) : 140 ± 2.5 ml per leg (for TOP make)
Brake fluid	: TVS Girling DOT 3/DOT 4*



Caution

Using the bulb other than the specified rating can result in overloading of the electrical system or premature failure of the bulb.



Note

Specifications are subjected to change without notice.

* Applicable only for Disc version

** The fuel tank is not a measuring instrument and the capacity of fuel tank may slightly vary from the indicated capacity.

GENERAL INFORMATION



Dear Customer,

It is mandatory under the Motor Vehicles Act to insure all motor vehicles. No motor vehicle can be used in a public place without a valid policy of insurance issued by an authorised insurer. Driving a motor vehicle without any such insurance is an offence under Motor Vehicles Act.

To assist our customers on their insurance requirements such as the prompt issue and renewal of policies as well as expeditious settlement of claims if any, our preferred insurers are :

