



MARATHON 125 / 200
MARATHON PRO 125 / 200
ENDURO / SUPERMOTARD

OWNER'S MANUAL



Bienvenu! welcome! Bienvenido!



***GARANTIE CONSTRUCTEUR DE 2 ANS (PIÈCES ET MAIN D'OEUVRE). TWO YEARS OF WARRANTY (PARTS AND MANPOWER). DOS AÑOS DE GARANTIA (M.O.Y PIEZAS).**

OWNER'S MANUAL

MARATHON 125 / 200

MARATHON PRO 125 / 200

ENDURO / SUPERMOTARD



english

RIEJU S.A. is grateful for the confidence you have put in their company and would like to congratulate you on your excellent choice.

The Marathon 125/200 c.c. are the result of the long-term experience that RIEJU has had in competitions, which has led to the development of a high performance vehicle.

The objective of this owner's manual is to denote the use and maintenance of your vehicle, we ask you to read the instructions and information that follow carefully.

We wish to remind you that the life of the vehicle depends on how it is maintained. Maintaining the vehicle in perfect working condition reduces the cost of repair.

This manual has to be considered as an integral component of the motorbike and must remain part of the basic equipment, and handed over in the event of a change of vehicle ownership.

In the event of any problems, please consult the RIEJU dealer who will assist you.

Please remember that for your motorbike to perform correctly, you should always **fit original spare parts.**

INDEX

	Page		Page
Description of the mortorbike	4	Routine testing	21
Identification of the mortorbike	5	- Front brake	21
Principal elements of the mortorbike	6	- Rear brake	22
- Keys	6	- Brake fluid and brake pads	22
- Instruments and indicators	6	- Throttle twist grip	23
- Electric handlebar switch	15	- Lights and indicators	23
- Clutch lever	17	- Start switch	23
- Front brake lever	17	- Tyres	24
- Rear brake pedal	17	Motorcycle operation	25
- Gear box	17	- Starting the motor	25
- Petrol tank	18	- Running In	26
- Petrol tap	19	- Acceleration	26
Checks before using mortorbike	20	- Braking	26
		- Stopping	27
		- Gear box	27

	Page
Carburettor	27
Front suspension	28
Rear suspension	28
Cooling system	29
Spark plug checks	30
Air filter	31
Transmission, Rear chain adjustment and lubrication	33
Gearbox Oil change	35
Cleaning, lubrication and storage	36

	Page
Technical specifications and characteristics	38

MORTORBIKE DESCRIPTION

This mortorbike has a 124 cc or 182,67 cc single cylinder; liquid cooled four stroke motor. With a piston diameter of 52 mm or 63 mm and it has a 58,6 mm bore.

The motor has an electronic Ignition system, CDI and a high-tension coil. The Generator provides 120 Watts and 12 volts via a regulator to supply power for the bike electrics.

Engine power is delivered to final drive chain via a Multiple metal clutch with constant pressure springs, submerged in an oil bath.

The engine is anchored to a highly resistant frame, with tapered steering bearings.

The front suspension in the Marathon 125/200 PRO consists of a hydraulic fork with bars which have a diameter of 41 mm. The rear suspension with variable transmission consists of a shock absorber anchored to a progressive articulated rod system (Progressive Racing System - PRS) which provides great operational smoothness with variable transmission also incorporate a gas shock absorber with spring preload adjustment.

In the versión Marathon 125/200 cc. complete fork consist hydraulic fork with \varnothing 37 mm., with hydraulic rear shockabsorber.

The front disk brake is made of stainless steel and has a diameter of 300 mm and 200 mm with floating caliper at models PRO. The front disc brake is 260 mm and rear is \varnothing 200 mm at normal version.

IDENTIFICATION OF THE MORTORBIKE

On the chassis you will find your mortorbike's identification number engraved .

The number is stamped on the right hand side of the front frame (Steering head.) is unique to every machine. This number is required to register your vehicle, this chassis or Vin number should be quoted when requesting warranty assistance or genuine Rieju spare parts.



PRINCIPAL ELEMENTS OF THE MORTORBIKE

KEYS

With this model, you will be given a set of keys, which are used for the Ignition switch/Steering lock. These keys are joined together by a small plastic panel, where the key number is engraved. We recommend that this number is kept in a safe place in case the keys are lost.

INSTRUMENT AND INDICATORS

1-.Main Ignitions switch

The Ignition switch has three positions: the Ignition off position, the start or Ignition on position and a third position which switches on the front and rear lights of the bike.

2-. Speedometer (Kmh and Mph)

The speedometer has the odometer fitted, which is calibrated in kilometres

4-. Out of gear (Neutral) indicator (Green.)

This light comes on when the gear change lever is in the neutral (N) position, that is to say, out of gear.

5-. Temperature warning lamp (Red.)

This light is very important as it can tell us if there is an excessive increase in engine running temperature due to an engine fault or a low level of cooling liquid in the radiator.

7-. Headlight Main beam warning light (Blue)

This indicator comes on when the headlights are on main beam.

9-. Direction indicator warning lamp (Green)

This indicator comes on when we activate the direction indicators.





INSTRUCTION OF FUNCTION

Speedometer

- Display unit: Km/h or MPH.

Indicator lights

- High beam light (Blue) 
- Direction light (Green) 
- Oil light (Red) 
- Neutral light (Green) 
- Temperature alarm (red) 

Odo meter

- Display range 0-99999 Km (mile)
 - Display unit: 1 Km (mile)
- Trip meter
- Display range 0-9999,9 Km (mile)
 - Display Unit 0,1 Km (mile)

Select button

- Press the Select button in the main screen to switch between 12/24 hour mode, speedometer record, stopwatch, and MAX record.

- Clock: 12/24 MODE
- Stopwatch: According to setup distance to record the testing time
- Speed Log: Average speed and max speed record



Volt Meter:

- Display range 4 levels

Adjust Button

- Press the Adjust button in the main screen to switch between ODO, Trip A/B, Total Hour meter, Hour meter A/B.
- Press and hold the Adjust button for 3 seconds in Trip A/B screen to reset.
- Press and hold the Adjust button for 3 seconds in Hour meter A/B screen to reset.

FUNCTION SWITCH INSTRUCTION

■ Adjust button function instruction



■ In main screen, press the **Adjust button** once to switch the function from odometer to trip.

■ In main screen, you could hold pressing the **Adjust button** for 3 seconds to change the speed unit.



■ Press the **Adjust button** to switch from trip A to trip B.

■ Hold pressing the **Adjust button** for 3 seconds to reset the trip A.



■ Press the **Adjust button** to switch from trip B to total hour meter.

■ Hold pressing the **Adjust Button** for 3 seconds to reset the trip B.





- Press the **Adjust button** to switch from total hour meter to hour meter A.



- Press the **Adjust button** to switch from hour meter A to hour meter B.
- Press and hold the **Adjust button** for 3 seconds to reset the hour meter A.

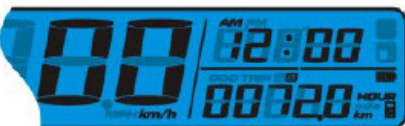

- Press the **Adjust button** to switch from hour meter B to back to the main screen
- Press and hold the **Adjust button** for 3 seconds to reset the hour meter B.



- The main screen.

■ Select button function instruction



- Press the **Select button** during main screen to switch from Clock to Stopwatch.
- Press and hold the **Select button** for 3 seconds to change between 12/24 hour mode.



NOTE: If 24 hour mode is chosen then the AM/PM symbol will not be displayed.



- Press the **Select button** to switch from Stopwatch to Speed Record.
- Press and hold the **Select button** for 1 seconds to reset the Stopwatch.



- Press the **Select button** to switch from Speed Record back to main screen.
- Press and hold the **Select button** for 3 seconds to reset the Speed Record.



NOTE: Average speed and the Max speed display in the 3 seconds rotation

TO ENTER THE SETTING MODE

■ Adjust + Select X3 function instruction



- In main screen, press down the **Adjust and Select button** for 3 seconds to enter the tire circumference and sensing point setting (for changing different size tire.)



- The tire circumference and sensor point setting.
- Press the **Adjust Button** to enter the circumference setting.



- **The tire circumference setting:**
 - * The tire circumference is **1912** from **ENDURO** bikes.
 - * The tire circumference is **1854** from **SMOTARD** bikes.
- Press the **Adjust Button** to move the digit you want to set.



- Press the **Select Button** to change the setting.
- Press the **Adjust Button** for three times to enter the sensing point setting.



- **Sensing point setting**
- Press the **Select button** to move to the digit you want to set.
 - * The sensing point is 1 for **REED** Sensor.
 - * The sensing point is 3 for **HALL** Sensor.
- Press **Adjust button** to go back to tire circumferences value & sensing point setting screen.

HALL Sensor



REED Sensor



- To enter the clock (Hour) Setting press the **Adjust button** on the circumferences value & sensing point setting screen.
- Press the **Select button** to enter the clock (Hour) setting.



- **The clock(Hour) setting**
- Press the **Select button** to choose the hour you want to set (setting range is 0 to 24 H)
- Press the **Adjust Button** to enter the minute setting.



- The clock (minute) setting
- Press the **Select button** to choose the minute you want to set.
- Press **Adjust button** to get back to Clock setting screen



- To enter Stopwatch distance setup press the **Adjust button** on the circumferences value & sensing point setting screen.
- Press the **Select button** to enter the distance setup for Stopwatch.



- **Distance setup for Stopwatch**
 - Press **Adjust button** to go back to the Stopwatch setting screen.
 - Press the **Select button** to change the setting
- NOTE :** The range of distance for Stopwatch is from 100m to 2000m



- To switch to main screen in Stopwatch screen, press **Adjust button** to go back to main screen
- Hold pressing the **Adjust button** for 3 seconds to go back to main screen.

HANDLE BAR SWITCHES (Left hand side.)

1-. Indicator Switch

This has 3 positions: in the centre position it is deactivated, to indicate right it must be moved to the right and to indicate left it must be moved to the left. Note that the button always returns to the central position, to switch off the direction indicators push button.

2-. Horn button (Red)

Press the button to activate the horn.

3-. Main and dip beam light switch

This switch has two positions: when it's down the dip beam is on and in the upper position the main beam is illuminated. The lights run directly from the engine, to switch the lights on the Ignition key has to be turned towards the lighting position.

Marathon 125/200 PRO

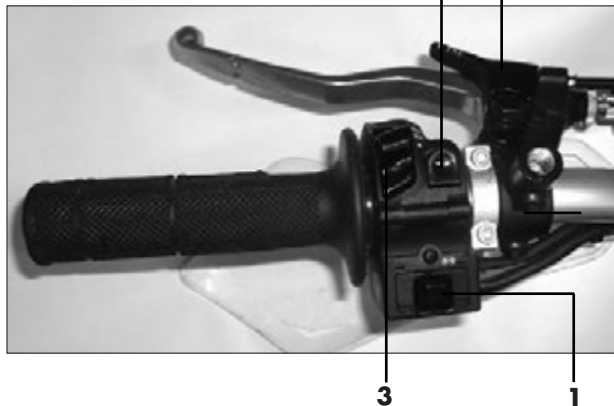

4-. Cold start (CHOKE)

When the motor is cold, the choke lever should be placed in the On position.

CAUTION: Once the motor has reached it's normal working temperature, return the choke lever go back to it's original position, otherwise it could cause the motor to misfire.

Marathon 125/200

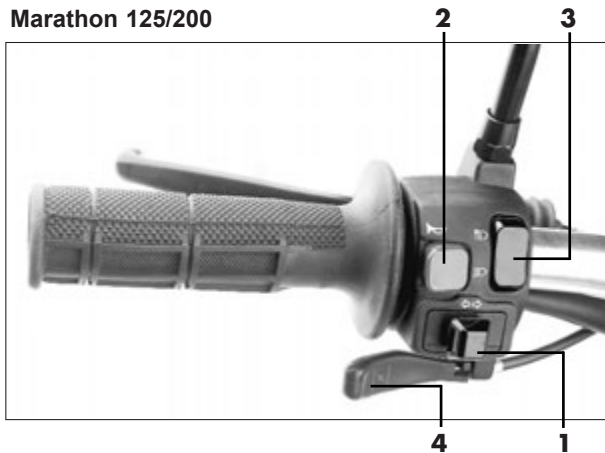

CLUTCH LEVER

The clutch lever is situated on the left-hand side of the handlebar. To activate it, pull the lever towards the grip or handlebar.

FRONT BRAKE LEVER

The front brake lever is situated on the right-hand side of the handlebar. To activate the front brake, pull the lever towards the handlebar.

REAR BRAKE PEDAL

The rear brake pedal is on the right-hand side of the motorbike. To activate it, press downwards with the foot.

GEAR BOX PEDAL

This is situated underneath the left part of the motor, it is activated with the foot taking it all the way and then letting it go back to its' original position before changing gear again. To put the motorbike into first gear, the pedal has to be pressed downwards. To change the other gears, lift the lever upwards with the toe.

PETROL TANK

To get to the tank, open it using the stopper of the tank, turning it anti-clockwise.

Remember that petrol without oil must always be used.

The capacity of the tank is 6.3 litres.



PETROL TAP

The petrol tap is situated on the left-hand side of the vehicle, under the fuel tank.

It has three positions:

OFF: with the lever in this position, the fuel will not go through. Put the lever in this position when the motor is not running when parked and garaged.

ON: with the lever in this position, the fuel goes to the carburettor. Normal driving is done with the lever in this position.

RES: this position is RESERVE. If you run out of fuel while you are driving with the lever in the "ON" position, turn the lever to this position. Fill the tank as soon as possible, then it is important to remember to turn the lever back to "ON".

Petrol tap



CHECKS BEFORE USING MORTORBIKE.

Check the following points before using your mortorbike:

Items to be checked

Lights and indicators
Front and rear brakes
Accelerator grip
Petrol tank
Tyres
Indicators (Instrument panel.)
Clutch
Transmission chain

Check-up

Check if they work correctly
Check the brake pads for wear and test brakes
Check the set, regulate and lubricate if necessary
Check level and fill if necessary
Check the tyre pressure and wear
Check if they work correctly
Check adjustment and smooth operation
Check tension and condition of chain and sprockets plus lubricate.

Each time the vehicle is used, it should be checked as above.

A complete check does not take more than a few minutes.

If during these checks any abnormality is established, it should be repaired before using the mortorbike.

ROUTINE TESTING

FRONT BRAKE

Pulling in the front brake lever operates the front brake by pumping brake fluid from the master cylinder to the front brake calliper. The brake pads are pushed by the calliper pistons against the front disc. Slowing the bike down.

The braking surface of the disc should be free of oil and dirt to ensure maximum braking efficiency. If for any reason the master cylinder is empty of brake fluid after checking for pad wear it should be topped up as necessary. If there is air in the system the brakes will need to be bled. Loosen the bleed nipple on the front calliper, putting a petrol tube onto the nipple. This tube should be put in a recipient so as not to spill brake fluid. Undo the brake nipple on the calliper 1 or 2 turns only and gently operate the front brake lever so that the brake fluid goes down, until it comes out through the tube without any air bubbles. At this point, hold the brake lever in and close the bleed nipple. Top up the master cylinder reservoir as necessary with DOT 4 brake fluid. Replace the top and check brake efficiency.



Bleed nipple

REAR BRAKE

Periodically check the brake fluid level in the reservoir situated on top of the rear brake master cylinder and under the rear right hand panel, to top up, use Dot 4 brake fluid.

If the reservoir is empty please go to your local Rieju dealer.

BRAKE FLUID LEVEL AND BRAKE PAD WEAR

Check that the level of brake fluid is correct, if not, Check for brake pad wear. If the pad material is less than 2mm thick, the pads should be replaced. If the pads are not worn out, top up the brake reservoir with brake fluid.

(WARNING Brake fluid is corrosive and will damage paintwork, if spilt wash off with water immediately)

Liquid deposit back brake



Always remember that the above must be carried out by a RIEJU official service.

THROTTLE TWIST GRIP

Ensure it works correctly, by turning the grip and verifying if the free play is correct. The grip should return to closed position when released.

LIGHTS, INDICATORS AND WARNING LAMPS

Check operation of all lights, and direction indicators plus the oil warning lamp and petrol reserve panel lights. Replace bulbs as necessary.

START SWITCH

This switch is used to start the engine, after verifying that the gear-change pedal is in the neutral position.

Marathon 125/200 Pro



Start switch

Marathon 1257200



Start switch

TYRES

The tyre pressure directly effect the road holding ride comfort and braking distance, the, therefore check the tyre pressures regularly for your own safety.

Make sure that the rim is central and not damaged, as well as the wear on the tyres.

Do not overload the vehicle as this will effect stability, and increases tyre wear.

CAUTION: when the pressure is very high, the tyres can no longer absorb any shocks, transmitting any road surface defects directly to the chassis, handlebar and rider.

PRESSURES		
Tyre	Front	Rear
Enduro	1,7 Kg/Cm ²	1,8 Kg/Cm ²
Supermotard	1,8 Kg/Cm ²	1,9 Kg/Cm ²

MORTORBIKE OPERATION

It is very important to know how to operate your vehicle correctly.

NOTE: remember that you must not leave the motor running in an enclosed area, as the toxic gas from the exhaust could cause serious health problems.

STARTING AND RIDING.

Open the petrol tap.

If the motor is cold, fully open the choke lever.

Turn the ignition key one position clockwise and check the engine is in neutral, with the throttle closed press the starting button to turn the engine over.

TO RIDE AWAY

Pull in the clutch lever and put the mortorbike in first gear (Down one click), slowly release the clutch lever while at the same time accelerating slowly once moving allow the clutch lever to go its rest position (OUT) and ride away.

Do not accelerate too much until the motor is warm enough.

CAUTION: Before riding the motor should be warm, never accelerate or ride hard when the motor is cold. This will prevent pre-mature damage to your engine.

RUNNING IN

The most important period of your mortarbike's life is between 0 and 500 kilometres and because of this we ask you to read the following instructions carefully. In the first 500 kilometres, the mortarbike must not be overworked as the motor is new and the different parts of the motor have to wear in, until it works perfectly. During this period, avoid prolonged use of the mortarbike at high revolutions or in conditions that could cause overheating.

ACCELERATION

Riding speed and acceleration is controlled by opening or closing the throttle. Operating the twist grip toward you increases the speed and away from decreases the engine revolutions.

TO BRAKE (SLOWING DOWN)

Close the throttle; activate the front and rear brakes simultaneously, increasing the pressure progressively.

NOTE: Sudden braking can cause skidding

STOPPING

Close the throttle and activate both brakes simultaneously and when the vehicle has reduced speed, Pull in the clutch lever all the way. To stop the motor, switch off the ignition and remove key.

Once the motor has stopped always close the petrol tap.

GEAR BOX PEDAL

The Gear lever is located near the left hand engine case of the motor and is activated with the foot taking it all the way down or up, letting it come back to its' original position before changing gear again. To put the mortorbike into first gear, the pedal has to be pushed downwards, to put in the 2,3,4,5,6 gears lift the lever up as far as it will go with the toe. Gear changing should be done carefully to ensure the gear you want is selected before releasing the clutch.

CARBURETTOR

The carburettor provides the correct petrol air mixture to the engine. If the settings are tampered with poor performance and/or overheating may occur. If you have any problems please refer to your Rieju dealer.

FRONT SUSPENSION

The front suspension consists of a hydraulic fork which has been crafted to the highest standards of technology and design.

Front Fork Marathon 125/200 PRO

Inverted front fork

Ø 41 mm. fork tubes

Oil capacity: 400 c.c. per leg

Type oil recommended: SAE 15W

Front Fork Marathon 125/200

Front fork

Ø 37 mm. fork tubes

Oil capacity: 310 c.c. per leg

Type oil recommended: SAE 10W

REAR SUSPENSION

Marathon 125/200 PRO: The rear suspension consists of a gas-assisted hydraulic mono-shock absorber with separate gas reservoir and spring preload adjustment via the nut located under the shock absorber spring by means of the PRS progressive articulated rod system.

Marathon 125/200: Hydraulic rear shockabsorber.



Threaded brass rings

COOLING SYSTEM

The radiator is mounted on the front right-hand side of the motorbike behind a protective grill; The radiators propose is to maintain a constant engine temperature by cooling the hot water which is pumped around the engine.

To check the level of coolant, carefully undo the radiator cap off and top up if necessary.

NOTE: never open the top of the radiator when the motor is hot, because the boiling liquid could escape under the pressure, which is dangerous.

It is strongly recommended that you use a closed circuit anti-freeze liquid. In this way we can avoid the water freezing causing damage to the water pump and water pipe ruptures. Do not top up with tap water as the calcium content could damage the radiator.



SPARK PLUG CHECK

The spark plug is an important part of the motor and it is easy to check. Take the spark plug out and check it periodically, the high combustion temperatures and carbon deposits may effect the efficiency of the engine. If the electrode is too eroded or carbon deposits are excessive, change the spark plug.

The correct plug is a NGK R CR8E

Before fitting a new spark plug, check the gap between electrodes. This gap must be between 0,6-0,7mm.

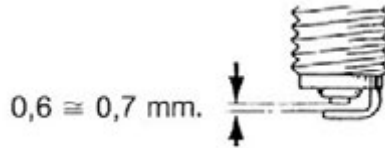

When installing the spark plug, always clean the area, around the plug hole to prevent any dirt etc. from entering the combustion chamber. Screw the spark plug in by hand, trying to make sure that it is not cross threaded finally tighten it $\frac{1}{8}$ or $\frac{1}{4}$ a turn with the plug spanner.

AIR FILTER

To ensure that the engine runs correctly, the air filter must be kept clean and oiled.

In order to access the air filter, disassemble the motorbike seat, allowing free access to the filter box. Remove the cover, which is attached to the box by a screw, and remove the filter housing.



After removal, check to see if the foam filter is blocked, in which case wash in paraffin, apply some air filter foam oil then squeeze the filter material between your hands to remove surplus oil. Do not wring out the filter element, as this will damage the foam.

When refitting the air filter sure that the foam fits the box correctly so that no air can enter the engine without being filtered. It must be cleaned more frequently if the mortorbike is used in humid or dusty places.



TRANSMISSION CHAIN ADJUSTING AND LUBRICATION

To correct the chain tension, loosen the rear axle bolts and turn the adjustment plates of the rear wheel axle clockwise to tighten the chain and anti-clockwise to loosen the chain. Turn the rear wheel several times and check the tension in various areas to find the point at which the chain is at its tightest point.

To check the chain adjustment the chain tensioner must be pulled away from the chain. The chain should have 35 – 45 mm of movement.

Chain tolerance 35-45 mm.

Chain tensioner



Try not to over tighten the chain, as it will stretch and wear the sprockets much quicker and may damage the gearbox.

If the wheel and chain are badly aligned, this can cause the chain to come off, and severely affect the bikes handling.

Periodically, it is necessary to clean and grease the chain. The chain is made up of many pieces which all work together. If the chain is not maintained properly, it will wear very quickly, therefore, it is advisable to grease the chain periodically with the correct chain lubricant.

Before lubrication, it is necessary to clean the chain to remove the dirt and the mud with a brush or a cloth and then apply the chain lube to all the chain links and sprockets.

GEARBOX OIL CHANGE PRO MODELS.

The gearbox and the clutch are lubricated by the action of the same gearbox oil. The recommended oil is SAE 10W 30 / SAE 20W 50, with a total gearbox capacity of 1000 c.c.

A drainage bolt situated in the bottom right-hand side of the motor empties the gearbox. It is recommended that you change the oil when the motor is still warm, as the oil will flow easier. Remove the drain plug and wait for the gearbox to empty completely.

Once it's empty, replace the drain plug. Remove level plug (See picture.) Fill the gearbox through the black plastic filler cap on the top of the gearbox), until the oil just starts to run out of the level hole.

Put the screw in its place one time is empty, take out the cap and fill with 1000 c.c. of oil.



Drain plug

**Filling cork and
level hole**

CLEANING, LUBRICATION AND STORAGE

CLEANING. Frequent and thorough cleaning of your vehicle is an important part of maintenance and will reduce the risk of corrosion and help the resale value if the vehicle looks good.

Near to areas in the sea or high mountain where salt is used on the road, we recommend a cleaning of the vehicle after use to prevent corrosion by the effects of salt. It is important to make a good clean at those points where the salt cumulates.

1. Before cleaning:
 - a) Cover the end of the exhaust to stop water getting inside.
 - b) Make sure that the spark plug and filler caps are fitted correctly.
2. If the motor is very dirty or greasy, use a degreasing agent (Refer to note above.) Do not apply this to the wheel axles or the chain, because that would remove any protective layer of lubricant.
3. Using a hose pipe remove the degreasing agent and dirt, but only with the pressure that is necessary. (DO NOT USE A PRESSURE WASHER.)

NOTE: Rieju is not responsible for the use of degreasing agents that may stain or mark the body work or chassis.

Rieju is not responsible for the possible damage and wear and tear due to using a pressure hose to clean the vehicle.

4. Once the dirt has been removed, wash all the surfaces with warm water and soft detergent. To get to the difficult areas, use a bottle-washing brush or something similar.
5. Immediately rinse with cold water and dry all the surfaces.
6. Clean the seat with a combination vinyl upholstery cleaner to keep it lustre and flexible.
7. To finish off, start the motor and let it run slowly for a few minutes. This way we can dry the bike out completely

STORAGE.

Storage of the mortorbike for a long period of time demands certain care to prevent deterioration. Once it is clean and lubricated, prepare to store the mortorbike in the following manner:

1. Drain the petrol tank, petrol pipes and the carburettor bowl.
2. Take the spark plug out and put a spoonful of SAE 10W30 oil through the plug hole and replace the spark plug.
3. Cover the exhaust with a plastic bag to stop the humidity getting in.
4. Completely cover a bike with a sheet to keep of dust.

TECHNICAL SPECIFICATIONS AND CHARACTERISTICS

Model	ENDURO / SUPER MOTARD
Dimensions: Total length Total width Total height Total seat height Distance between axles Minimum distance to the floor	2070 mm. / 2070 mm. 800 mm. / 800 mm. 1165 mm. / 1145 mm. 890 mm. / 870 mm. 1405 mm. / 1380 mm. 310 mm. / 288 mm.
Basic weight:	121 Kg.
Engine PRO: Type Number of gears Make Model Cylinders Engine capacity Piston size, bore Starter system Lubrication system Oil type	4 stroke water cooled 6 gears YAMAHA WR (EU 3) liquid cooled 1 inclined forwards 124 c.c. / 182.67 cc 52 x 58,6 mm / 63 x 58,6 mm Kick start / Starting button Pump 4 stroke SAE 10W-30 / SAE 20W-50

Huile de transmission: Type Quantity	SAE 10W-30 / SAE 20W-50 1000 c.c.
Air filter	Humid rubber foam
Petrol: Type Tank capacity	Unleaded petrol 95 6,3 L
Carburettor	KEIHIN 39S
Bougie: Type Electrodes separation	NGK CR 8 E 0,6 - 0,7 mm
Clutch type	Multidisks in oil bath
Secondary transmission Front sprocket Rear sprocket Transmission relation Chain	Z = 14 Z = 56 1 : 4 428 x 136 pas

SPEED CHANGE				
Speed	Primary tree	Secondary tree	Gear change ratio	
1°	Z = 12	Z = 34	1 : 2,83	
2°	Z = 16	Z = 30	1 : 1,87	
3°	Z = 22	Z = 30	1 : 1,36	
4°	Z = 21	Z = 24	1 : 1,14	
5°	Z = 23	Z = 22	1 : 0,95	
6°	Z = 25	Z = 21	1 : 0,84	

<p>Suspension Marathon 125 / 200 Pro</p> <p>Front</p> <p>Rear</p>	<p>Upside down forks Ø 41 mm. OIL FORK SAE 15W, 400 cc each leg.</p> <p>Gas shock absorber with a bottle and manual adjustment for pre load spring.</p>
<p>Suspension Marathon 125 / 200</p> <p>Front</p> <p>Rear</p>	<p>Upside down forks Ø 37 mm. OIL FORK SAE 10W, 310 cc each leg.</p> <p>Hydraulic monoshock.</p>

<p>Brakes: Marathon 125 / 200 Pro Front Rear Brakes: Marathon 125 / 200 Front Rear</p>	<p>Type disc Wave 300 mm Ø Type disc Wave 200 mm Ø</p> <p>Ø 260 mm disc Ø 200 mm disc</p>
<p>Tyres: ENDURO Front Rear</p> <p> SUPER MOTARD Front Rear</p>	<p>80/90 - 21, with inner tube, 1'7 kg/cm² 110/80 - 18, with inner tube, 1'8 kg/cm²</p> <p>100/80 - 17, with inner tube, 1'8 kg/cm² 130/70 - 17, with inner tube, 1'9 kg/cm²</p>
<p>Electric equipement: Ignition</p>	<p>Electronic 12 v 120 w</p>

Voltage and bulb output:

Light

12 v 35/35 w

Rear pilot light

12 v 21/5 w

Instrument cluster

12 v 1,2 w

Indicators

12 v 10 w

Odometer lighting

12 v 1,2 w



RIEJU[®]
...for everyday adventure



 www.riejumoto.com



 **RIEJU, S A** Borrassà 41 / P O Box 9 - E17600 FIGUERES (GIRONA-SPAIN) T+34 972 500 850 FAX+34 972 506 950 rieju@riejumoto.com

* VOUS BÉNÉFICIEZ D'UNE GARANTIE CONSTRUCTEUR DE 2 ANS (PIÈCES ET MAIN D'OEUVRE) TWO YEARS OF TOTAL WARRANTY IN OUR PRODUCTS (PARTS AND MANPOWER) DOS AÑOS DE GARANTIA (M O Y PIEZAS)