



2010

OWNERS MANUAL

This owner's manual should be considered a permanent part of your BRAMMO Enertia and remain with the Enertia if it is ever resold.

This manual contains information that was available at the time of printing. BRAMMO reserves the right to make changes at any time, without notice and without any further obligation.

©BRAMMO, Inc.

**TRADEMARK AND COPYRIGHT INFORMATION:** All material in this manual, including, but not limited to, text, data, graphics, logos, and images are owned and controlled by BRAMMO, Inc. and is protected by copyright, trademark, and other intellectual property rights. Material in the manual is made available solely for your personal, non-commercial use and may not be copied, reproduced, republished, modified, uploaded, posted, transmitted, or distributed in any way, including by e-mail or other electronic means, without the express prior written consent of BRAMMO, Inc. for each instance. You may use material made available from the manual for your personal, non-commercial use only, provided that you keep intact any and all copyright and other proprietary notices that may appear on such materials.

2010

Brammo Evertia

Owner's Manual



# Introduction

Congratulations, and thank you for choosing a BRAMMO Eertia.

Thorough familiarity with your Eertia and its features will provide you with enhanced control and enjoyment when you ride it.

Please take the time to read this owner's manual and familiarize yourself with the all the information that we have prepared for you before riding your new BRAMMO Eertia. The manual contains important data and instructions intended to assist you in gaining maximum use and satisfaction from your Eertia's capabilities.

The manual also contains information on maintenance to enhance operating safety and contribute to maintaining the value of your BRAMMO throughout its life.

We wish you an enjoyable riding experience.

BRAMMO

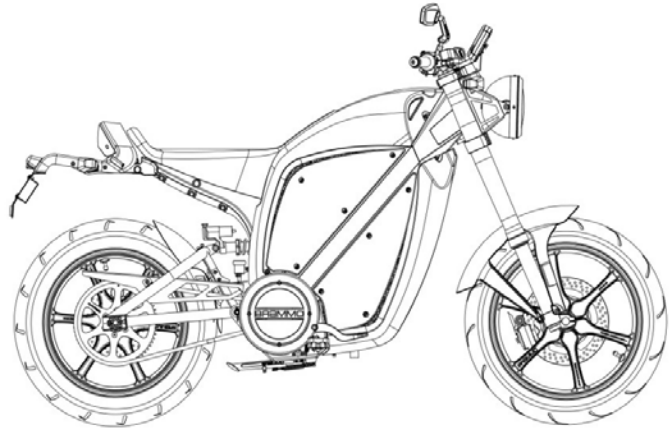

# Introduction

Your Enertia is equipped with many advanced features including:

## **Premium Motorcycle Parts**

Extruded Aluminum Frame | Suspension | Brakes | Seat | Wide Non-Slip Foot Pegs | BRAMMO Wheels  
Tubeless Tires | Plastics with Recycled Content

## **Drive Train**

Sealed Permanent Magnet AC-Synchronous Disc-Motor | Power (continuous) - 7.0 Kilowatts (9.39 HP), Torque - 8.19 ft/lb (11.1Nm)  
Sophisticated Motor Controller | Direct Drive (No Gears / No Clutch)

## **Batteries**

Lithium Iron Phosphate Technology | 3.1 Kilowatt Hours of Capacity | Thousands of Charge/Discharge Cycles  
Battery Management System | Cell Balancing | Maintenance Free

## **Charger**

Onboard 110/220VAC 720 Watt Charger | Microprocessor Controlled | 4-5 Hour Charge Time

## **Custom Electronics**

Vehicle Control Unit | Dash with LCD Display | Onboard Diagnostics & Logging | Immobilizer Security System | Electronic Throttle

## **Support**

BRAMMO Service

# A Few Words about Safety

Your safety, and the safety of others, is very important. And operating an Enertia safely is an important responsibility.

To help you make informed decisions about safety, we have provided operating procedures in this manual. This information alerts you to potential hazards that could hurt you or others.

Of course, it is not practical or possible to warn you about all hazards associated with operating or maintaining a motorcycle. You must use your own good judgment.

You will find important safety information in a variety of forms, including:

## **NOTE**

When you see this symbol in the manual this means the information is important and following the instructions will lead to a more enjoyable experience.

## **WARNING**

When you see this symbol in the manual this means the information is very important and failure to follow the warning could result in injury or death.

This entire manual is filled with important safety information – please read it carefully.

# Table of Contents

This page give an overview of the contents of your owner’s manual.

**Motorcycle Safety ..... 8**

Important safety information you should know, plus a look at the safety related labels on your motorcycle.

**Instruments & Controls ..... 13**

The location and function of indicators, gauges, and controls on your Enertia and operating instructions for various controls and features. Setting the clock.

**Before Riding ..... 24**

The importance of wearing a helmet and other protective gear, how to make sure you and your Enertia are ready to ride, and important information about loading.

**Basic Operation & Riding ..... 30**

Powering up the Enertia in drive mode, enabling the drive system, braking, disabling the drive system, turning the Enertia off, and parking.

**Batteries, BMS & Charging ..... 38**

Battery, Battery Management System, and Charger information. Powering up the Enertia in charge mode, turning off the Enertia while in charge mode, detailed charging information.

**Servicing your Enertia ..... 42**

Why your Enertia needs regular maintenance, what you need to know before servicing your Enertia, an owner maintenance schedule, and instructions for specific maintenance and adjustment items.

**Tips ..... 69**

How to store and transport your Enertia.

**Taking Care of the Unexpected ..... 71**

What to do if you have a flat tire, blown fuse, or you crash. Also a listing of warnings and error codes reported by your Enertia and what they mean.

**Technical Information ..... 79**

How to store and transport your Enertia.

**Consumer Information ..... 82**

Information on warranties, contacting BRAMMO, reporting safety defects to NHTSA.

**Index ..... 86**

**Notes ..... 88**

**Quick Reference ..... 90**

Quick information about your Enertia, including powering up in drive mode, enabling the drive system, charging.

# Important Safety Information

Your Enertia can provide many years of service and pleasure – if you take responsibility for your own safety and understand the challenges you can experience while riding.

**Always Wear a Helmet** – It’s a proven fact: helmets significantly reduce the number and severity of head injuries. Always wear an approved motorcycle helmet. We also recommend that you wear eye protection, sturdy boots, gloves and other protective gear.

**Take Time to Learn & Practice** – Even if you have ridden other motorcycles, take time to become familiar with how this Enertia works and handles. Practice in a safe area until you build your skills and get accustomed to the Enertia’s size and weight. Because accidents often involve inexperienced or untrained riders, we urge all riders to take a certified course approved by the Motorcycle Safety Foundation (MSF).

**Ride Defensively** – The most frequent motorcycle collision happens when an oncoming car turns left in front of a motorcycle. Another common situation is a car moving suddenly into your lane. Always pay attention to other vehicles around you, and do not assume that other drivers see you. Be prepared to stop quickly or make an evasive maneuver.

**Make Yourself Easy to See** – Some drivers do not see motorcycles because they are not looking for them. To make yourself more visible, wear bright reflective clothing, position yourself so other drivers can see you, signal before turning or changing lanes, and use your horn when it will help others notice you.

**Ride within Your Limits** – Pushing limits is another major cause of motorcycle accidents. Never ride beyond your personal abilities or faster than conditions warrant. Remember that alcohol, drugs, fatigue, and inattention can significantly reduce your ability to make good judgments and ride safely.



# Important Safety Information

**Don't Drink and Ride** – Alcohol and riding don't mix. Even one drink can reduce your ability to respond to changing conditions, and your reaction time gets worse with every additional drink. So don't drink and ride, and don't let your friends drink and ride either.

**Keep Your Enertia in Safe Condition** – It's important to keep your Enertia properly maintained and in safe riding condition. To help avoid problems, inspect your Enertia before every ride and perform all recommended maintenance. Never exceed load limits, and do not modify your Enertia or install accessories that would make your Enertia unsafe.

# Accessories & Modifications

Modifying your Enertia or using non-BRAMMO accessories can make your Enertia unsafe. Before you consider making any modification or adding an accessory, be sure to read the following information.

## Accessories

We strongly recommend that you use only BRAMMO Accessories that have been specifically designed and tested for your Enertia. Because BRAMMO cannot test all other accessories, you must be personally responsible for the proper selection, installation, and use of non-BRAMMO accessories.

Check with your BRAMMO Authorized Service Agent for assistance and always follow these guidelines:

- Make sure the accessory does not obscure any lights, reduce ground clearance, limit lean angle, limit suspension travel or steering travel, alter your riding position, or interfere with operating any controls.
- Do not add any electrical equipment that will exceed the Enertia's electrical system capacity. A blown fuse can cause a loss of lights or motor power.
- Do not pull a trailer or sidecar with your Enertia. This Enertia was not designed for these attachments, and their use can seriously impair your Enertia's handling.

# Accessories & Modifications

## Modifications

We strongly advise you not to remove any original equipment or modify your Enertia in any way that would change its design or operation. Such changes could seriously impair your Enertia's handling, stability, and braking making it unsafe to ride.

Removing or modifying your lights, or other equipment can also make your Enertia illegal.

### **WARNING**

Improper accessories or modifications can cause a crash in which you can be seriously hurt or killed.

Follow all instruction in this owner's manual regarding accessories and modifications.

# Safety Labels

Safety labels on your Enertia either warn you of potential hazards that could cause serious injury or they provide important safety information. Read these labels carefully and don't remove them. If a label comes off or becomes hard to read, contact your BRAMMO Authorized Service Agent for a replacement.

Safety Certification Label

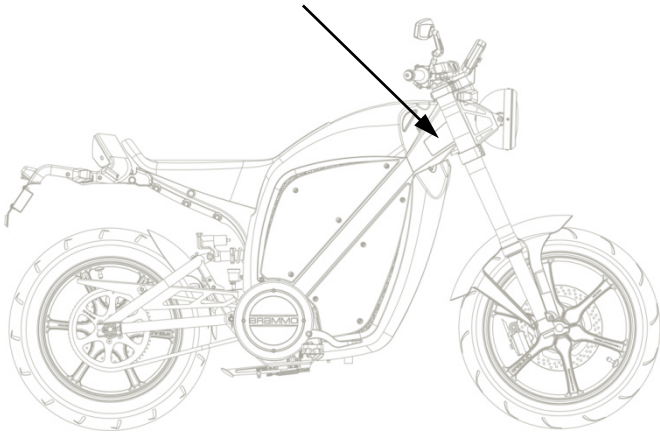

Emissions Label

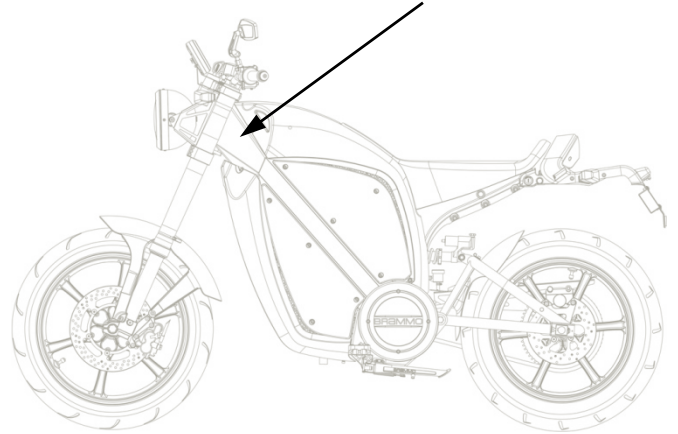

# Operation Component Location

This section shows the location of all controls, gauges, and indicators you would normally use before or while riding your Enertia.

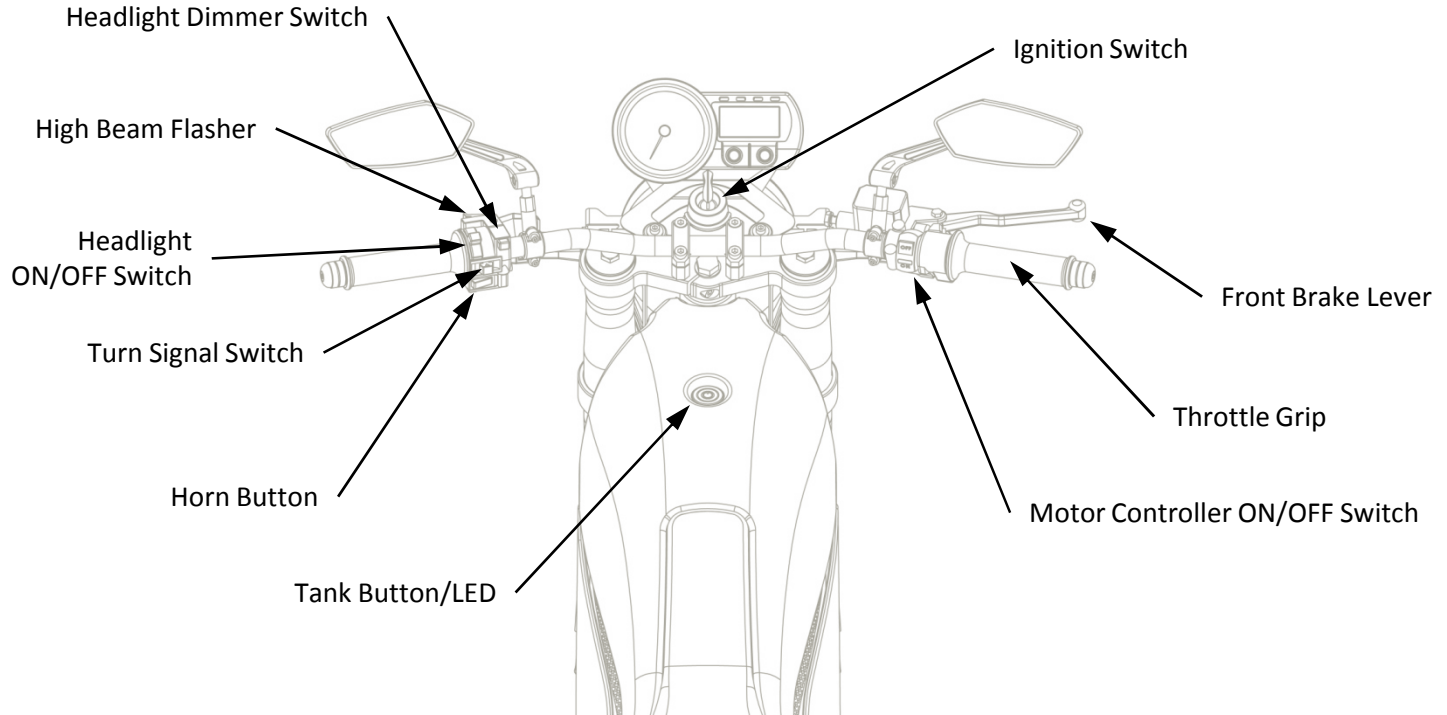

# Operation Component Location

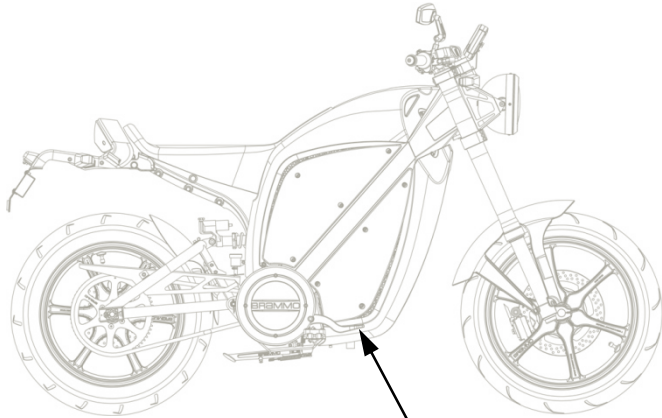

Rear Brake Pedal

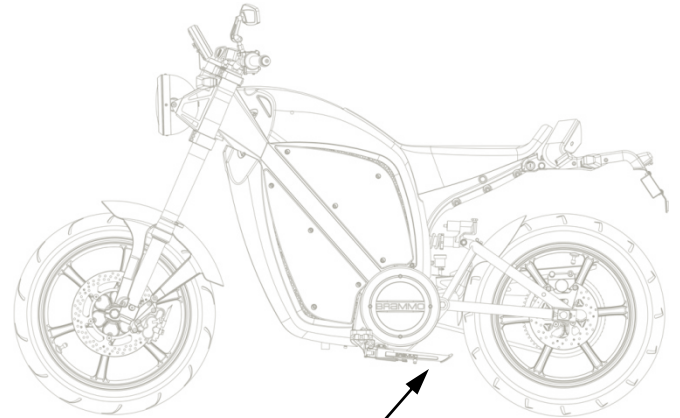

Kickstand





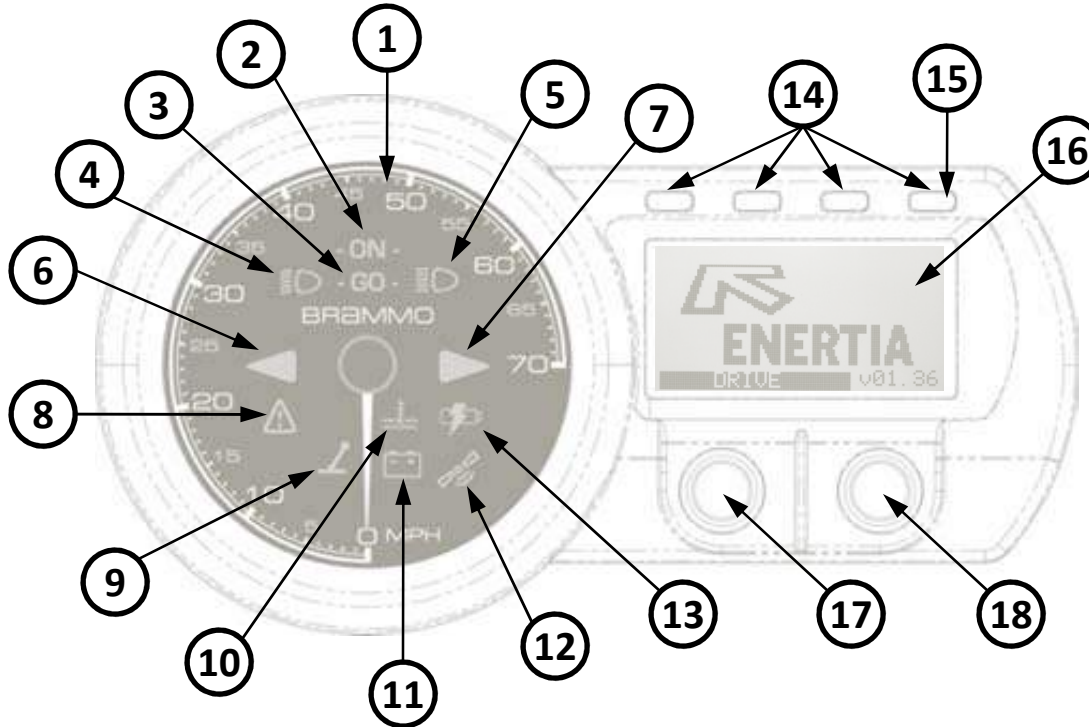

# Gauges, Indicators & Displays

The gauges, indicators and displays on your Enertia keep you informed, alert you to possible problems, and make your riding safer and more enjoyable. Refer to the gauges, indicators and displays frequently. Their functions are described on the following pages.







1. Speedometer
2. ON Indicator
3. GO Indicator
4. Low Beam Indicator
5. High Beam Indicator
6. Left Turn Indicator
7. Right Turn Indicator
8. System Attention Indicator
9. Kickstand Down Indicator
10. Motor Over Temperature Indicator
11. Battery Low/Discharged Indicator
12. GPS Signal Indicator
13. Charging Status Indicator
14. Drive Enabled Indicators
15. Immobilizer Indicator
16. LCD Display
17. Mode Button
18. Trip Button

## Gauges, Indicators & Displays

1	Speedometer		Shows the speed of the Enertia in miles per hour (mph).
2	On Indicator (orange)	- ON -	Lights orange when the Enertia is powered up.
3	GO Indicator (green)	- GO -	Lights green when the Enertia's drive system is enabled.
4	Low Beam Indicator (orange)		Lights orange when the headlight is on low beam.
5	High Beam Indicator (blue)		Lights blue when the headlight is on high beam.
6	Left Turn Signal Indicator (green)		Flashes green when the left turn signal operates.
7	Right Turn Signal Indicator (green)		Flashes green when the right turn signal operates.
8	System Attention Indicator (red)		Flashes red when the Enertia has detected a fault or warning. Will also always be accompanied by a fault or warning message on the LCD.
9	Kickstand Down Indicator (red)		Lights red when the kickstand is down.



## Gauges, Indicators & Displays

10	<p>Motor Over Temperature Indicator (red)</p> 	<p>Lights red when the temperature of the motor has reached 110°C (230°F). Will also be accompanied by a THERMAL CUTBACK message on the LCD. Additionally, to protect the motor's magnets from demagnetization, the motor controller will reduce the available power to 80% of normal. If the motor temperature continues to climb and reaches 115°C (239°F) the motor controller will further reduce the available power to 60% of normal. If the motor temperature continues to climb and reaches 120°C (248°F) the motor controller will further reduce the available power to 50% of normal. Once the temperature of the motor drops below 110°C (230°F), this indicator will turn off and full power will be restored.</p>
11	<p>Battery Low/Discharged Indicator (orange/red)</p> 	<p>Lights orange when the battery State of Charge (SoC) drops below 20%, also a BATTERIES LOW message will be displayed on the LCD. Flashes red when the battery State of Charge (SoC) drops below 0%, also a RECHARGE REQ'D message will be displayed on the LCD.</p>
12	<p>GPS Signal Indicator (optional) (blue)</p> 	<p>Lights blue when the Enertia is receiving good GPS satellite signal.</p>
13	<p>Charge Status Indicator (orange/green)</p> 	<p>Lights orange when the Enertia is in charge mode and A/C power is connected. Lights green when the Enertia's batteries are at or above 95% State of Charge (SoC).</p>
14	<p>Drive Enabled Indicators (green)</p>	<p>Sequentially flash green when the Enertia's drive system is enabled.</p>

# Gauges, Indicators & Displays

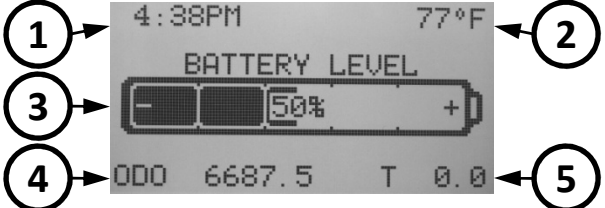
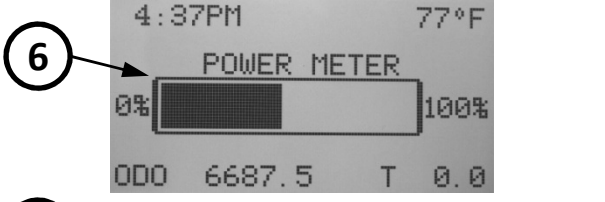
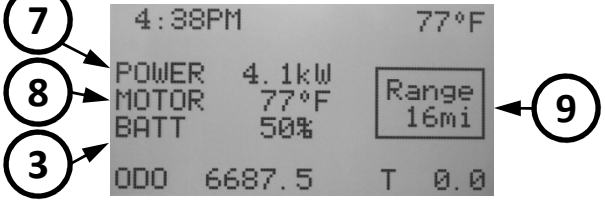
15	Immobilizer Indicator (red)	Flashes red when the Enertia is powered off. Does not light during normal operation.
16	<p>LCD Display</p> <ol style="list-style-type: none"> <li>1. Current Time</li> <li>2. Air Temperature (inside Enertia's body panels)</li> <li>3. Battery State of Charge (SoC)</li> <li>4. Odometer</li> <li>5. Trip Odometer</li> <li>6. Power Meter</li> <li>7. Motor Power in Kilowatts</li> <li>8. Motor Temperature</li> <li>9. Estimated Miles Remaining</li> </ol>	<p>Battery Status</p>  <p>Motor Power</p>  <p>Summary</p> 
17	Mode Button	Used to cycle between the Battery Status, Motor Power, and Summary screens. Also used to enter setup mode (see page 23).
18	Trip Button	Used to reset the Trip Odometer. Also used to set the hour in setup mode.

# Gauges, Indicators & Displays

## Indicator Check

All indicators will light for a few seconds and then turn off when the Enertia powers up. The ON indicator will then light and remain on. When applicable, the other indicators will light under certain conditions. These indicators' conditions are identified on the table on pages 16 – 17.

If one of the indicators does not light during the indicator check, contact your BRAMMO Authorized Service Agent as soon as possible.

## Meter Check

The speedometer needle will swing to full speed and then zero when the Enertia powers up.

If the speedometer needle does not zero, contact your BRAMMO Authorized Service Agent as soon as possible.

## Display Check

When the Enertia powers up, the LCD display will temporarily show all black so you can make sure the liquid crystal display is functioning properly. The LCD backlight will always be illuminated when the Enertia is powered up.

If any part of the display does not come on, or the backlight is not illuminated, contact your BRAMMO Authorized Service Agent as soon as possible.

# Controls & Features

## Ignition Switch

The ignition switch is used to SELECT the operational mode of the bike, either ON or CHARGE mode, and to lock the steering for theft prevention. Insert the key and turn clockwise to the ON position. Turn the handlebar all the way to the left (or right), push down on the key and turn counter clockwise to the LOCK (steering lock) position. From the LOCK position turn the key counter clockwise to the CHARGE position. The key can be removed in the LOCK and CHARGE positions.

## Tank Button

The Tank Button is used to power the Enertia up. After placing the ignition in either the ON position or the CHARGE position, press and hold the Tank Button until the Enertia powers up.

Key Position	Function
ON	Enertia powers up in drive mode.
OFF	No electrical circuits function.
LOCK (steering lock)	No electrical circuits function. Locks the steering head.
CHARGE	Enertia powers up in charge mode. Locks the steering head.

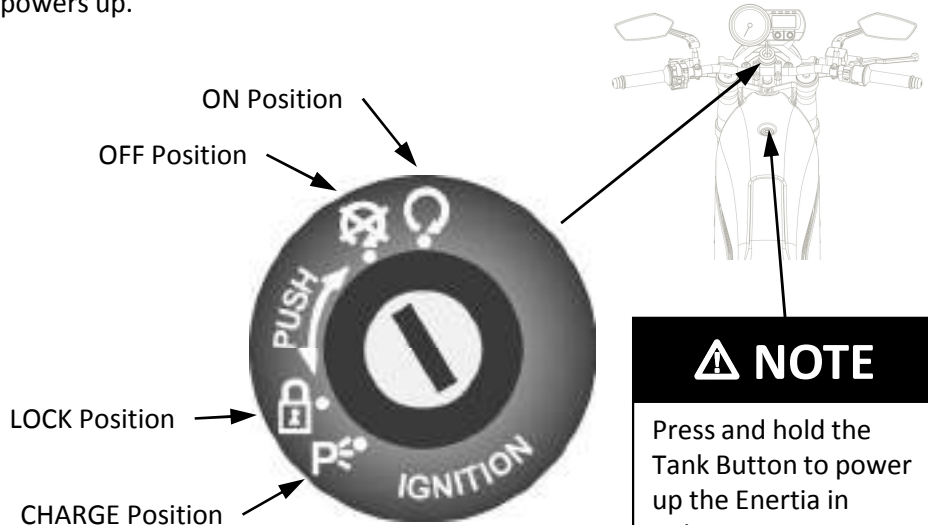

**NOTE**  
Press and hold the Tank Button to power up the Enertia in either ON or CHARGE mode.

# Controls & Features

## Motor Controller OFF/ON Switch

The motor controller OFF/ON switch is used to turn the motor controller off and on. Before powering up the Enertia in the DRIVE Mode, ensure that the OFF/ON switch is in the OFF position.

### WARNING

The throttle could be live when the OFF/ON switch is placed in the ON position. Use extreme caution.

To operate, after the Enertia is powered up in DRIVE Mode:

Place the OFF/ON switch in the ON position to power on the motor controller.

Place the OFF/ON switch in the OFF position to power off the motor controller.

Only place the OFF/ON switch in the ON position when you're ready to ride. When parking for any length of time, for safety, it is recommended that you power off the motor controller by placing the OFF/ON switch in the OFF position.

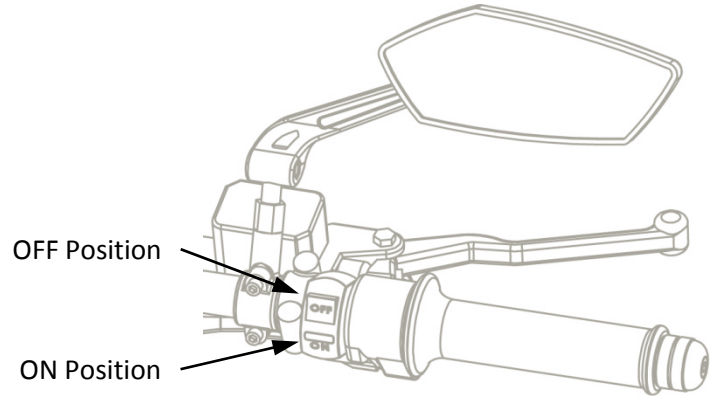

RIGHT HANDLEBAR

### NOTE

If the OFF/ON switch was in the ON position prior to powering up the Enertia in the DRIVE Mode, you must place the OFF/ON switch in the OFF position and then to the ON position to power up the motor controller.

# Controls & Features

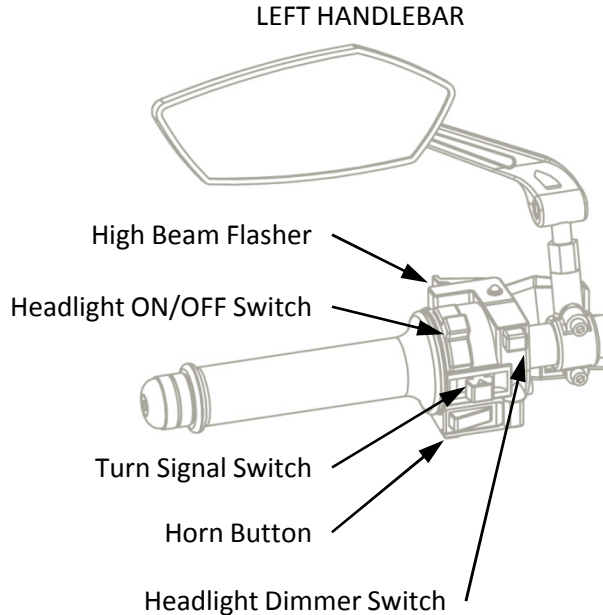

## Headlight ON/OFF Switch

The headlight ON/OFF switch is used to turn the headlight on or off. To operate, slide the switch fully forward to turn on the headlight, slide fully backward to turn off the headlight.

## Headlight Dimmer Switch

The headlight dimmer switch is used to change between the high and low beams of the headlight. To operate, turn the switch to HI for high beam, LO for low.

## High Beam Flasher

The high beam flasher is used to alert other motorists. To operate, pull the momentary switch.

## Turn Signal Switch

The turn signal switch is used to signal a turn or a lane change. To operate, move the switch all the way in the proper direction and release it. The appropriate turn signal lights will start blinking. To cancel the light, push the switch in.

## Horn Button

The horn is used to alert others motorists. To operate, push the horn button.

# Setting the Time

The time and date on your Enertia were set at the factory to Pacific Standard Time. If you need to adjust the time on your Enertia:

## Entering SETUP MODE.

1. Turn the handlebar all the way to the left (or right).
2. Insert key into the ignition.
3. Push in on the key and turn it to the LOCK position (counterclockwise).
4. Release the key, then continue turning the key to the CHARGE position (counterclockwise).
5. Press and hold the Dash MODE button.
6. Press and hold the Tank Button
7. Enertia will power up in the SETUP mode.
8. Adjust the hour by pressing the TRIP button.
9. Push in on the key and turn it to the OFF position (clockwise).

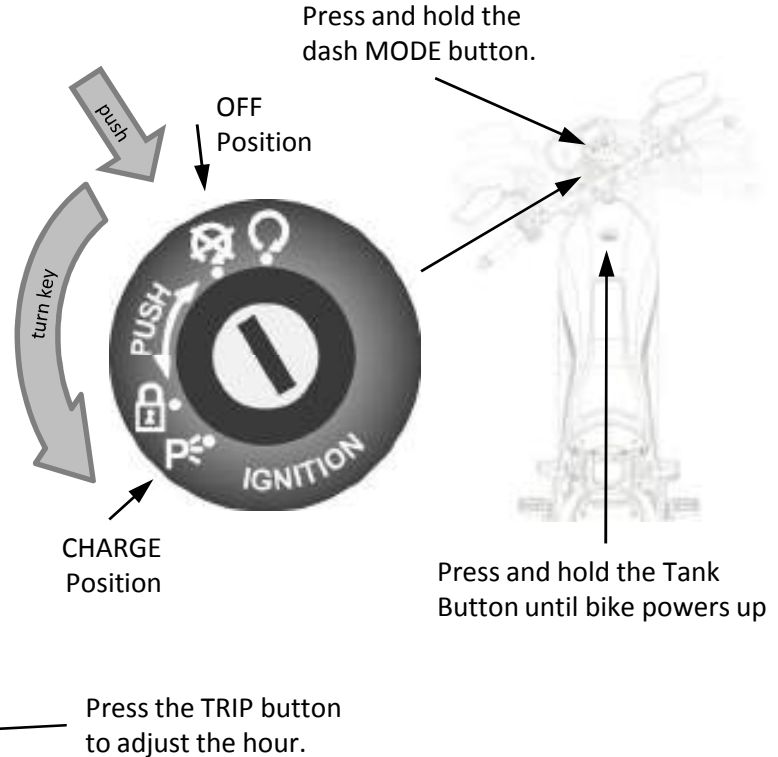
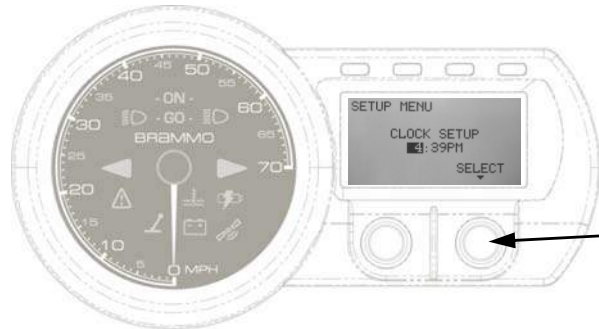

# Are You Ready to Ride?

Before you ride, you need to make sure you and your Enertia are both ready to ride. To help get you prepared, this section discusses how to evaluate your riding readiness, what items you should check on your Enertia, and adjustments to make for your comfort, convenience, or safety. This section also includes important information about loading.

Before you ride your Enertia for the first time, we urge you to:

- Read this owner's manual.
- Make sure you understand all the safety messages.
- Know how to operate all the controls

Before each ride, be sure:

- You feel well and are in good physical and mental condition.
- You are wearing an approved motorcycle helmet (with chin strap tightened securely), eye protection, and other protective clothing.
- You don't have any alcohol or drugs in your system.

## **WARNING**

Not wearing a helmet increases the chance of serious injury or death in a crash.

Be sure you always wear a helmet, eye protection, and other protective apparel when you ride.

## **WARNING**

### **ALCOHOL AND MOTORCYCLING IS A LETHAL MIX**

Alcohol is the leading cause of death among motorcyclists. Every year, nearly 50% of the riders killed in motorcycle crashes have been drinking.

**DON'T DRINK AND RIDE!!!**



# Are You Ready to Ride?

## Protective Apparel

For your safety, we strongly recommend that you always wear an approved motorcycle helmet, eye protection, boots, gloves, long pants, and a long-sleeved shirt or jacket whenever you ride. Following are suggestions to help you choose the proper gear.

## Helmets and Eye Protection

Your helmet is your most important piece of riding gear because it offers the best protection against head injuries. A helmet should fit your head comfortably and securely. A bright-colored helmet and reflective strips can make you more noticeable in traffic.

An open-face helmet offers some protection, but a full-face helmet offers more. Regardless of the style, look for a DOT (Department of Transportation) sticker on any helmet you buy (USA only). Always wear a face shield or goggles to protect your eyes and help your vision.

## Additional Riding Gear

In addition to a helmet and eye-protection, we also recommend:

- Sturdy boots with non-slip soles to help protect your feet and ankles.
- Leather gloves to help protect your hands.
- A motorcycle riding suit or jacket for comfort as well as protection. Bright-colored and reflective clothing can help make you more noticeable.

# Are You Ready to Ride?

## Rider Training

Developing your riding skills is an ongoing process. Even if you have ridden other motorcycles, take time to become familiar with how this motorcycle works and handles. Practice riding the Enertia in a safe area to build your skills. Do not ride in traffic until you get accustomed to the Enertia's controls, and feel comfortable with its size and weight.

We urge all riders to take a certified course approved by the Motorcycle Safety Foundation (MSF). New riders should start with the basic course, and even experienced riders will find the advanced course beneficial. For information about the MSF training course nearest you, call national toll-free number: (800) 446-9227.



[www.msf-usa.org](http://www.msf-usa.org)

# Is Your Enertia Ready to Ride?

## Pre-ride Inspection

Check to following items before you get on the Enertia:

- |                    |   |
|--------------------|---|
| Tires & Wheels     | Look at the tires. If a tire appears low, use an air pressure gauge to check its pressure. Also look for signs of excessive wear or damage to the tires and wheels. |
| Chain              | Check the condition of the chain. Adjust slack and lubricate as needed.   |
| Leaks, Loose Parts | Walk around your Enertia and look for anything that appears unusual, such as a leak or loose parts.   |
| Lights             | Make sure the headlight, running light, brakelight, taillight, license light and turn signals are working properly.   |

Check these items after you get on the Enertia:

- |                     |  |
|---------------------|--|
| Throttle            | Rotate the throttle to check it moves smoothly without binding.                        |
| Brakes              | Pull the brake lever and press on the brake pedal to check that they operate normally. |
| Gauges & Indicators | Power up the Enertia and check for normal operation of the gauge and indicators.       |

Periodic maintenance should be done at least once a month, no matter how often you ride. Remember, be sure to take care of any problem you find, or have your BRAMMO Authorized Service Agent correct it before you ride.

# Load Limits & Guidelines

Your Enertia has been designed to carry only you. The Enertia is not designed to carry a passenger. When you carry cargo, you may feel some difference during acceleration and braking. But as long as you keep your Enertia well-maintained, with good tires and brakes, you can safely carry loads within the given limits and guidelines.

## Loading

How much weight you put on your Enertia, and how you load it, are important for your safety. Anytime you ride with cargo, you should be aware of the following information.

### **WARNING**

Overloading or improper loading can cause a crash and you can be seriously hurt or killed. Follow all load limits and other loading guidelines in this manual.

## Loading Limits

Following are the load limits for your Enertia:

### **maximum weight capacity:**

276 lbs (125 kg)

Includes the weight of the rider, all cargo, and all accessories.

# Load Limits & Guidelines

## Loading Guidelines

Your Enertia is primarily intended for transporting you. You may wish to secure a jacket or other small items to the seat. If you wish to carry more cargo, check with your BRAMMO Authorized Service Agent for advice, and be sure to read the information regarding accessories.

Improperly loading your Enertia can affect its stability and handling. Even if your Enertia is properly loaded, you should ride at reduced speeds when carrying cargo.

Follow these guidelines whenever you carry cargo:

- Check that both tires are properly inflated.
- If you change your normal load, you may need to adjust the suspension.
- To prevent loose items from creating a hazard, make sure that all cargo is tied down securely before you ride.
- Place cargo weight as low and close to the center of your Enertia as possible.
- Balance cargo weight evenly on both sides.

# Basic Operation & Riding

This section gives basic riding instructions, including how to turn on your Enertia, how to enable and disable the drive system, how to use the throttle, and brakes.

Before riding your Enertia for the first time, please review the [Motorcycle Safety](#) section , and the [Before Riding](#) section. Even if you have ridden other motorcycles, take time to become familiar with how this Enertia works and handles. Practice in a safe area until you build your skills and get accustomed to the Enertia's size and weight.

# Powering Up in DRIVE Mode

## Preparation

The Enertia has many safety features designed to keep the drive system disabled until you are ready to ride. Before enabling the drive system:

1. The Enertia must be powered up in the DRIVE Mode.
2. The kickstand must be up.
3. The headlight must be in the on position.
4. OFF/ON switch must be in the ON position.

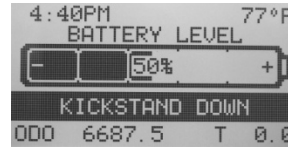

Kickstand down warning

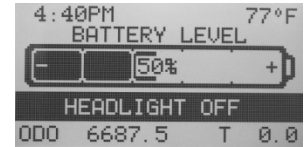

Headlight off warning

The drive system on the Enertia will not be enabled unless these conditions are satisfied. If the Enertia's drive system is enabled and one of these conditions are not satisfied, for example the kickstand is put down or the headlight is turned off, the drive system will be disabled.

## Powering up the Enertia in DRIVE Mode.

1. Insert key into the ignition switch.
2. Turn the ignition switch clockwise to the ON position.
3. Press and hold the Tank Button.
4. Enertia will power up in the DRIVE Mode.

After the Enertia powers up in the DRIVE Mode, the dash will illuminate, all lighting and the horn will function.

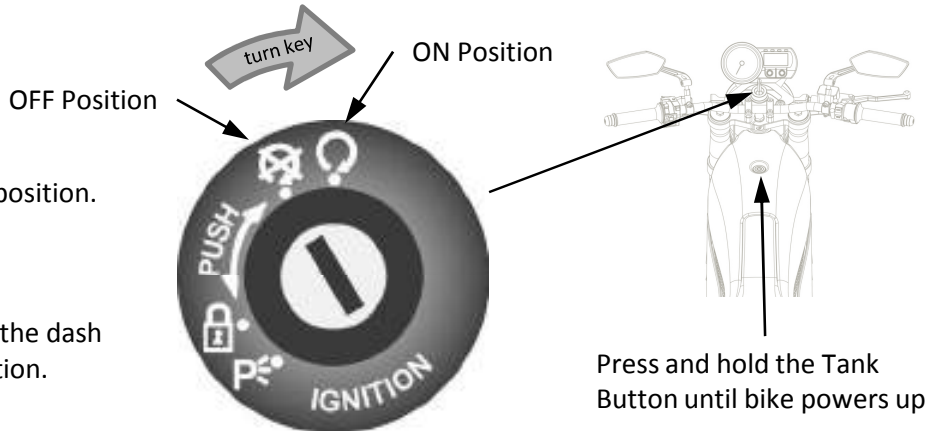

# Enabling the Drive System

## Enabling the Drive System and Riding the Enertia

With the Enertia powered up in DRIVE Mode:

1. Place the kickstand in the up position.
2. Turn the headlight on.
3. Place the OFF/ON switch in the ON position.

The drive system will energize. Immediately, you will hear a small relay “click” under the seat followed by the main contactor “click” from the motor area. The “GO” indicator on the dash will illuminate and the 4 LEDs above the LCD will blink indicating that the Enertia has successfully entered a safe operational state in DRIVE MODE.

When you carefully twist the throttle towards you, you are applying power to the motor and your Enertia will accelerate. When you carefully twist the throttle away from you, you limit or eliminate power going to the motor and your Enertia will not accelerate. The Enertia has no clutch or gears to operate, simply use the throttle and brakes to control your speed.

## **⚠ WARNING**

The throttle is live, use extreme caution.

## **⚠ NOTE**

When stopped with the drive system enabled, the 4 LEDs above the LCD will flash. While driving the Enertia, these LEDs will stop flashing until you come to a stop.

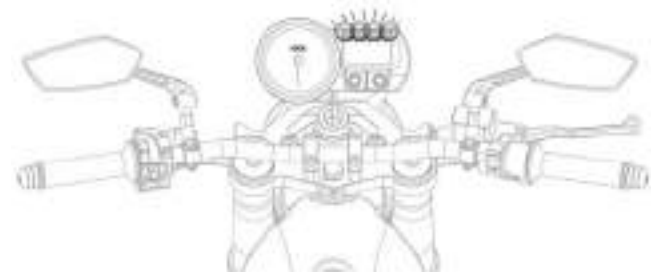



# Braking

Your Enertia is equipped with disc braking systems which are hydraulically activated. Operating the brake lever applies the front disc brake. Depressing the brake pedal applies the rear disc brake. As a general rule, the front braking system provides about 70 percent of total stopping power. For full braking effectiveness, use both the pedal and the lever simultaneously. Using both braking systems will stop your Enertia faster with greater stability.

## Proper Braking

1. To slow or stop, apply the brake lever and the brake pedal smoothly.
2. Gradually increase braking as you feel the brakes slowing your speed.
3. For support, put your left foot down first, then your right foot when you are finished using the brake pedal.

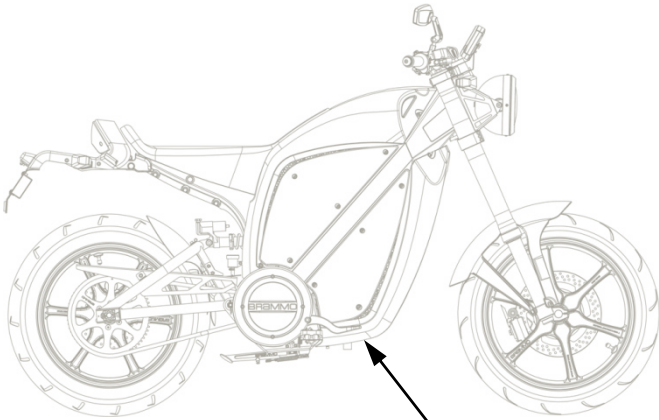

Rear Brake Pedal

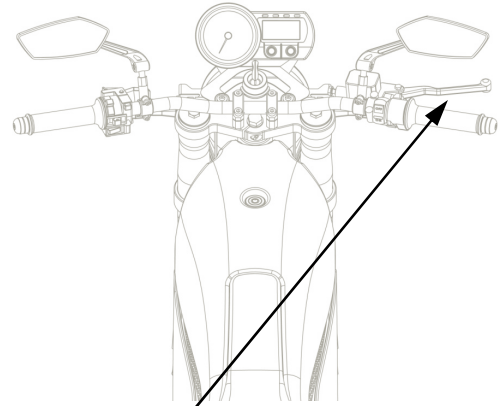

Front Brake Lever

# Braking

## **Braking DOs and DON'Ts**

Applying the brakes too hard may cause the wheels to lock and slide, reducing control of your Enertia. If this happens, release the brake controls, steer straight ahead until you regain control, then reapply the brakes more gently.

When possible, reduce your speed or complete braking before entering a turn. Avoid braking while turning. Braking in a turn may cause one or both wheels to slip and reduce control of your Enertia.

Your ability to brake in a turn and to brake hard in an emergency situation are important riding skills. We suggest attending a Motorcycle Safety Foundation experienced rider training course to retain these skills.

When riding in wet or rainy conditions, or on loose surfaces, the ability to maneuver and stop will be reduced. All of your actions should be smooth under these conditions. Rapid acceleration, braking, or turning may cause loss of control. For your safety, exercise extreme caution when braking, accelerating or turning.

When descending a long, steep grade, intermittently use both brakes. Continuous brake application can overheat the brakes and reduce their effectiveness.

Riding with your foot resting on the brake pedal or your hand on the brake lever may actuate the brakelight, giving a false indication to other drivers. It may also overheat the brakes, reducing effectiveness.

# Disabling the Drive System - Turning Enertia OFF

## Disabling the Drive System

There are several ways that the Enertia's drive system can be disabled:

1. Place the OFF/ON switch in the OFF position.
2. Turning the headlight off.
3. Putting the kickstand down.

Additionally, the Enertia's onboard Vehicle Control Unit can disable the drive system if a fault or warning is detected. For more information about faults and warnings see the troubleshooting section.

## Turning the Enertia Off

1. Turn the ignition switch counterclockwise to the OFF position.
2. Enertia will power OFF.

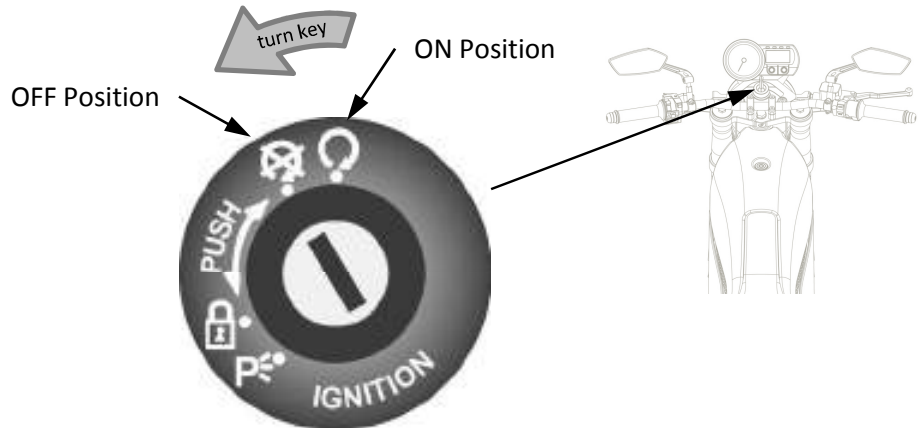

# Parking

Look for a level parking area. If you can't park on a paved surface, make sure the ground surface is firm, especially under the kickstand. If you must park on a hill, back the rear tire downhill against the curb with the Enertia at a 45 degree angle to the curb.

## Kickstand

Use the kickstand to support the Enertia while parked.

1. To lower the kickstand, use your foot to guide it down. Remember that lowering the kickstand will disable the drive system.
2. Check that the kickstand is down all the way.
3. If you have to park on a soft surface, insert something solid under the kickstand for support.

## Locking the Steering Lock

The steering lock is used to lock the handlebar in place.

To lock the steering lock:

1. Turn the handlebar all the way to the left (or right).
2. Insert key into the ignition.
3. Push in on the ignition key and turn it to the LOCK position (counterclockwise).
4. Remove the key from the ignition.

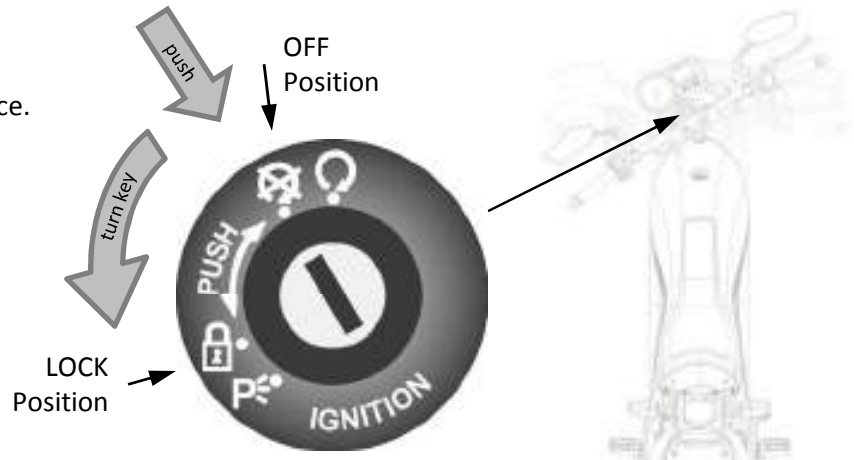

## Parking

### Unlocking the Steering Lock

To unlock the steering lock:

1. Insert key into the ignition.
2. Push in on the ignition key and turn it to the OFF position (clockwise).

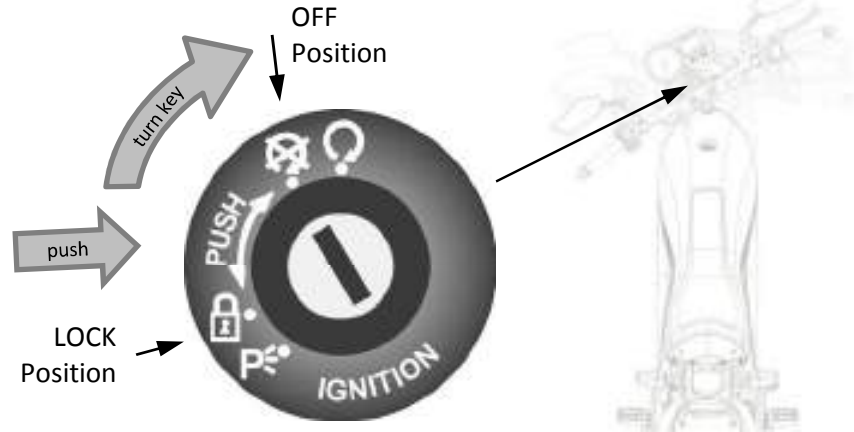

### Theft-Prevention Tips

- Park your Enertia in a locked garage whenever possible. If a garage isn't available, park in a concealed area or a well-lit area with enough pedestrian traffic to discourage a thief.
- Always take the ignition key with you.
- Always use the steering lock even if you're parking for just a minute or two. A thief can easily push an unlocked Enertia to a waiting truck.
- In addition to the steering lock, use a good quality anti-theft device made specifically to lock a motorcycle to a secure object.
- Keep your owner's manual, current registration, and insurance information with your Enertia. This will make it easier for the authorities to find you if your Enertia is stolen and recovered.

# Battery Modules, BMS & Charger

This section of the owner's manual covers the onboard Battery Modules, Battery Management System and the Charger. All information regarding charging and keeping your Enertia's batteries in peak operating condition will be covered here.

Your Enertia is equipped with:

1. Six (6) rechargeable Lithium-Ion Battery Modules. These battery modules use Lithium Phosphate Technology that provide the lithium-ion advantages of high energy, light weight, and long cycle life without the fear of thermal runaway event under abuse conditions. Each battery module is rated at 512Whr for a total of 3.1KWhr onboard. Each of the 6 battery modules contains 4 cell stacks for a total 24 onboard cell stacks. Each cell has a nominal cell voltage of 3.3 volts for a total battery stack voltage of just under 80 volts. Under normal operating conditions, your Enertia's battery modules are rated for thousands of charge cycles.
2. A Battery Management System (BMS) monitors each battery module's state of charge, current, cell voltage and temperature.
3. An onboard charger designed to operate from a standard 110V (or 220V using a optional power cord) household outlet. Normal charge time is just over 4 hours if the batteries are fully depleted.

## Maximizing Battery Capacity and Battery Life

By following the tips listed below, one can assure long life and high performance of your Enertia's Battery Modules.

- Operate your Enertia at temperatures below 104°F (40°C), charge at temperatures between 32°F (0°C) and 113°F (45°C).
- Cell balance as often as possible. Battery module cell variability and environmental conditions can cause slight state of charge imbalances between cells. After the normal charge cycle (batteries charged to 99%), cell balancing starts. During cell balancing, the battery modules, BMS and charger attempt to perfectly match all of the cell voltages. Leaving your Enertia powered up in charge mode with A/C power connected will maximize your battery modules' performance when not in use.
- Charge battery modules fully prior to long term storage.
- Charge battery modules fully if it has been stored for more than three (3) months.

# Charging

## Powering up the Enertia in CHARGE mode.

1. Turn the handlebar all the way to the left (or right).
2. Insert key into the ignition.
3. Push in on the key and turn it to the LOCK position (counterclockwise).
4. Release the key, then continue turning the key to the CHARGE position (counterclockwise).
5. Press and hold the Tank Button.
6. Enertia will power up in the CHARGE mode.
7. Remove the key.
8. Unlock the seat.
9. Plug the Enertia into a standard A/C outlet.

After the Enertia powers up in the CHARGE mode, the dash will illuminate, all lighting and the horn will function. When A/C power is detected, the Enertia will begin to charge.

While charging, the Enertia will display the estimated charge time remaining and state of charge in percentage.



4:41PM 77°F  
CHARGING REMAINING  
1:45 HOURS  
50% COMPLETE  
CONNECT AC POWER  
ODO 6687.5 T 0.0

A/C not connected warning

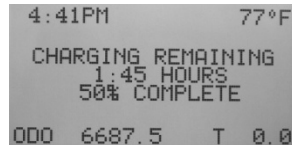

4:41PM 77°F  
CHARGING REMAINING  
1:45 HOURS  
50% COMPLETE  
ODO 6687.5 T 0.0

Charging Enertia screen

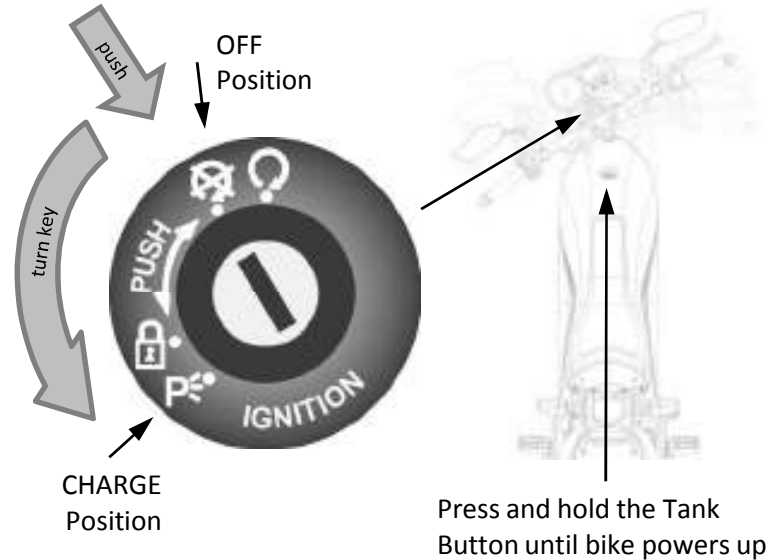

## ⚠ NOTE

The Enertia will automatically shut down in CHARGE mode if A/C power is not detected after 60 seconds. You have 60 seconds from the time the Enertia powers up in CHARGE mode to plug in the A/C power cord.

# Charging Complete

## Fully Charged

Once the CHARGING REMAINING reaches 99% COMPLETE, the majority of the charging is finished and your Enertia is ready to ride.

1. Insert key into the ignition (if it was removed).
2. Turn key to the LOCK position (clockwise).
3. Push in on the key and turn it to the OFF position (clockwise).
4. Remove key.
5. Open seat and store A/C power cord.
6. Close seat and lock.

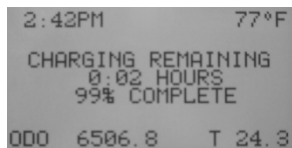

99% State of Charge

## Battery Cell Balancing

Keeping all of the 24 cell stacks balanced is vital to optimize battery performance. Brammo recommends that whenever possible leave your Enertia ON in charge mode with A/C power connected to allow the cells to balance.

## 100% State of Charge

When all of the battery modules report 100% SoC to the BMS, the LCD will then display 100% COMPLETE. Typically, you will see the % COMPLETE toggling between 100% and 99% once all battery modules reach 100% SoC.

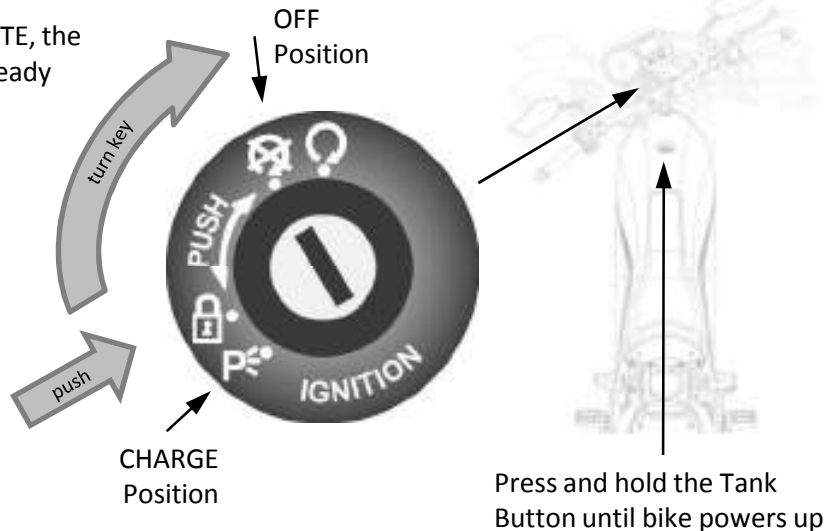



# Detailed Charging Information

While your Enertia is charging, press and hold the Tank Button for 7 seconds. The LCD will display the detailed charging information screen. The following information will be displayed:

1. High Cell Stack Voltage (cell stack 4 measuring 3.325 volts in the below example)
2. Low Cell Stack Voltage (cell stack 21 measuring 3.308 volts in the below example)
3. Total Battery Stack Voltage (80 volts in the below example)
4. Charge Current in Amps (charging at 8 amps in the below example)
5. State of Charge (50% SoC in the below example)

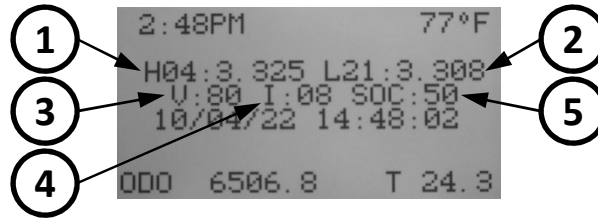

A complete charge and balanced can be defined as:

1. High Cell Stack Voltage = 3.750V – 3.800V
2. Low Cell Stack Voltage = 3.650V (or higher)
3. SoC toggling between 99% and 100%

The voltage difference between the (1) high cell stack and (2) low cell stack is the cell stack imbalance. If during charging the imbalance is greater than 100mV (0.1V), leave the bike on charge to correct the imbalance. The charge system will slowly correct the imbalance. Contact your BRAMMO Service Agent if the cell stack imbalance is not being corrected.

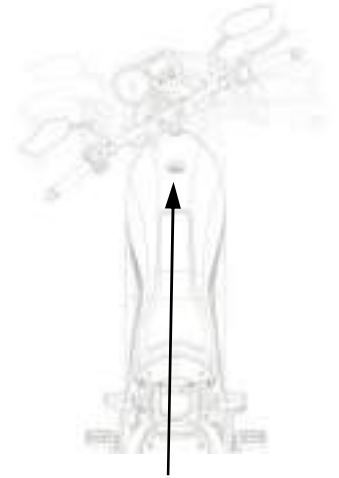

While charging, press and hold the Tank Button to display the detailed charging information screen. Pressing the tank button a 2<sup>nd</sup> time will display the default charging screen.

# Servicing Your Eertia

To help keep your Eertia in good shape, this section includes a Maintenance Schedule for required service, a pre-ride inspection, a list of periodic checks you should perform at least once a month, and step-by-step instructions for specific maintenance tasks. You'll also find important safety precautions, information on fluids and lubricants, and tips for keeping your Eertia looking great.

The following table summarizes the three types of inspections and servicing recommendations for your Eertia. Both the pre-ride inspection and the scheduled maintenance at the recommended intervals are necessary to assure safe and dependable performance. The periodic checks provide additional confidence in your Eertia's performance.

Type of Inspection/Service	Refer to page#	When Performed	Who Performs
Pre-ride Inspection	27	Before every ride	You
Periodic Maintenance	46	Monthly*	You
Maintenance Schedule	47	Interval on schedule	Your BRAMMO Service Agent**

\* more often if you ride frequently or long distances; or anytime you clean your Eertia.

\*\* unless you have the proper tools and service data and are mechanically qualified.

# The Importance of Maintenance

Keeping your Eertia well-maintained is absolutely essential to your safety. It's also a good way to protect your investment, get maximum performance, avoid breakdowns, and have more fun. A properly maintained Eertia will also help to reduce costly future repairs.

Remember, proper maintenance is the owner's responsibility. Be sure to inspect your Eertia before each ride, perform the periodic checks, and follow the Maintenance Schedule in this section.

## **WARNING**

Improperly maintaining this Eertia or failing to correct a problem before you ride can cause a crash in which you can be seriously hurt or killed.

Always follow the inspections and maintenance recommendations and schedules in this owner's manual.

If your Eertia overturns or is involved in a crash, be sure your BRAMMO Service Agent inspects all major parts, even if you are able to make some of the repairs yourself.

## Maintenance Safety

This section includes instructions on how to perform some important maintenance tasks. If you have basic mechanical skills, you can perform many of these tasks.

Other tasks that are more difficult and require special tools are best performed by professionals. Wheel removal should normally be handled only by a BRAMMO Authorized Service Agent or other qualified mechanic. Instructions are included in this manual only to assist in emergency service.

Some of the most important safety precautions follow. However, we cannot warn you of every conceivable hazard that can arise in performing maintenance. Only you can decide whether or not you should perform a given task.

### **WARNING**

Failure to properly follow maintenance instructions and precautions can cause you to be seriously hurt or killed.

Always follow the procedures and precautions in the owner's manual.

# Maintenance Safety

## Important Safety Precautions

- Make sure the ignition is OFF before you begin any maintenance or repairs. This will help eliminate several potential hazards:

**Electrical Shock.** High Voltage (80V max) exists on your Evertia, use extreme caution when working with or around any battery terminals, cables, bus bars, or other high voltage components. It is recommended to always disconnect the Blue Battery Safety Disconnect before working on any of the electrical systems.

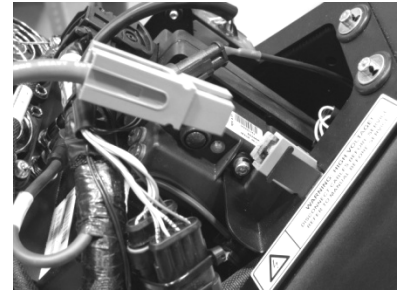
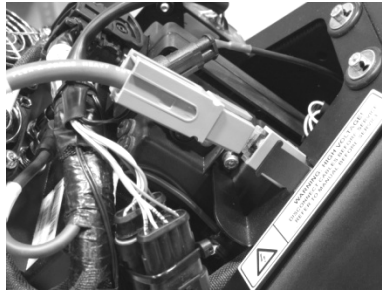
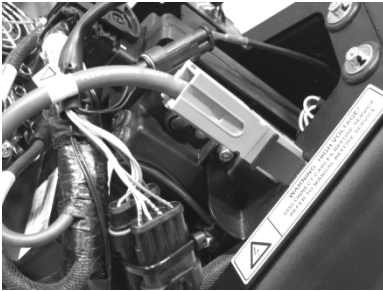

**Injury from moving parts.** Never run the motor during any service task.

- Read the instructions before you begin, and make sure you have the tools and skills required.
- To help prevent the Evertia from falling over, park it on a firm, level surface, using the kickstand or a maintenance stand to provide support.

Remember that your BRAMMO Authorized Service Agent or Dealer knows your Evertia best and is fully equipped to maintain it. To ensure the best quality and reliability, use only new BRAMMO Parts or their equivalents for repair and replacement.

# Periodic Maintenance

In addition to the regularly scheduled maintenance and daily pre-ride inspection, consider performing the periodic checks on the following table at least once a month, even if you haven't ridden your Enertia, or as often as once a week if you ride frequently or for long distances. It's a good idea to perform this maintenance any time you clean your Enertia.

Check the odometer reading and perform any scheduled maintenance checks that are needed. Remember, more frequent checks may be needed for riding in severe conditions.

Tires & Wheels	<ul style="list-style-type: none"><li>• Check the air pressure with a gauge and add air if needed.</li><li>• Examine the tread for wear. Look closely for nails, embedded objects, cuts, and other types of damage. Roll your Enertia so you can inspect the entire surface of the front and rear tires.</li><li>• Check the condition of the wheels.</li></ul>
Brake Fluid	<ul style="list-style-type: none"><li>• Check the levels of the front and rear brake fluid reservoirs. Add the correct fluid as necessary, and investigate the cause of any low fluid levels.</li></ul>
Lights	<ul style="list-style-type: none"><li>• Make sure the headlight, running light, brakelight, taillight, license light and turn signals are working properly.</li></ul>
Throttle Freeplay	<ul style="list-style-type: none"><li>• Check the freeplay of the throttle grip. Ensure that it turns smoothly and returns to the closed position when released.</li></ul>
Drive Chain	<ul style="list-style-type: none"><li>• Check condition, adjust slack, and lubricate as needed.</li></ul>
Fuses	<ul style="list-style-type: none"><li>• Make sure you have a full supply of spare fuses.</li></ul>
Nuts & Bolts	<ul style="list-style-type: none"><li>• Check the major fasteners and tighten as needed.</li></ul>

# Maintenance Schedule

The required Maintenance Schedule that follows specifies how often you should have your Enertia serviced, and what things need attention. It is essential to have your Enertia serviced as scheduled to maintain safe, dependable performance.

The service intervals in this Maintenance Schedule are based on average riding conditions. Some items will need more frequent service if you ride in unusually wet or dusty areas. Consult your BRAMMO Authorized Service Agent for recommendations applicable to your individual needs and use.

Some items in the Maintenance Schedule can be performed with basic mechanical skills and hand tools. Procedures for these items are provided in this manual. Other items involve more extensive procedures and may require special training, tools, and equipment. We recommend that you have your BRAMMO Authorized Service Agent perform these tasks unless you have advanced mechanical skills and the required tools and equipment.

If you do not feel capable of performing a given task or need assistance, remember that your BRAMMO Authorized Service Agent knows your Enertia best and is fully equipped to maintain and repair it. If you decide to do your own maintenance, use only BRAMMO Parts or their equivalents for repair or replacement to ensure the best quality and reliability.

Perform the pre-ride inspection and owner maintenance at each scheduled maintenance period.

Each item on the maintenance schedule requires some mechanical knowledge. Certain items (particularly those marked \* and \*\*) may require more technical information and tools. Consult your BRAMMO Authorized Service Agent.

# Maintenance Schedule

ITEM	FREQUENCY	ODOMETER READING (Note 1)								Refer to page
		x 1000 mi	0.6	4	8	12	16	20	24	
	NOTES	x 1000 km	1.0	6.4	12.8	19.2	25.6	32.0	38.4	
THROTTLE OPERATION			I		I		I		I	56
DRIVE CHAIN	1	EVERY 250mi (800km) I								63 - 65
BRAKE FLUID	2		I	I	I	R	I	I	R	58
BRAKE PAD WEAR			I	I	I	I	I	I	I	59
BRAKE SYSTEM			I		I		I		I	58
BRAKE LIGHT SWITCH	*				I		I		I	
HEADLIGHT AIM	*		I	I	I	I	I	I	I	
KICKSTAND					I		I		I	62
SUSPENSION	*				I		I		I	57
NUTS, BOLTS, AND FASTENERS	*		I		I		I		I	
WHEELS AND TIRES	**				I		I		I	60 - 61
STEERING HEAD BEARINGS	**		I		I		I		I	
BATTERY INSPECTION	**				I		I		I	66
DRIVE SYSTEM INSPECTION & TUNING	**				I		I		I	

## NOTES:

1. Inspect the drive chain every 250 miles. If riding in wet and dusty areas, inspect drive chain more often.
2. Replace every 2 years, or at indicated odometer interval, whichever comes first.

## Maintenance Procedures:

I - Inspect and Clean, Adjust, Lubricate, or Replace (if necessary)

R - Replace

\* Should be serviced by your BRAMMO Authorized Service Agent, unless you have the proper tools and service data and are mechanically qualified.

\*\* In the interest of safety, we recommend these items be serviced only by your BRAMMO Authorized Service Agent.



# Maintenance Record

Keeping an accurate maintenance record will help ensure that your Enertia is properly maintained. Retain detailed receipts to verify the maintenance was performed. If the Enertia is sold, these receipts should be transferred with the Enertia to the new owner. Make sure whoever performs the maintenance completes this record. All scheduled maintenance, including the 600 mile (1,000 km) initial maintenance, is considered a normal owner operating cost and you will be charged by your dealer. Use the space under notes to record anything you want to remind yourself about or mention to your dealer.

Miles (km)	Odometer	Date	Performed By:	Notes
600 (1,000)				
4,000 (6,400)				
8,000 (12,800)				
12,000 (19,200)				
16,000 (25,600)				
20,000 (32,000)				
24,000 (38,400)				
28,000 (57,600)				
32,000 (51,200)				
36,000 (57,600)				
40,000 (64,000)				
44,000 (70,400)				
48,000 (76,800)				
52,000 (83,200)				
56,000 (89,600)				
60,000 (96,000)				
64,000 (102,400)				
68,000 (108,800)				

# Maintenance Component Locations

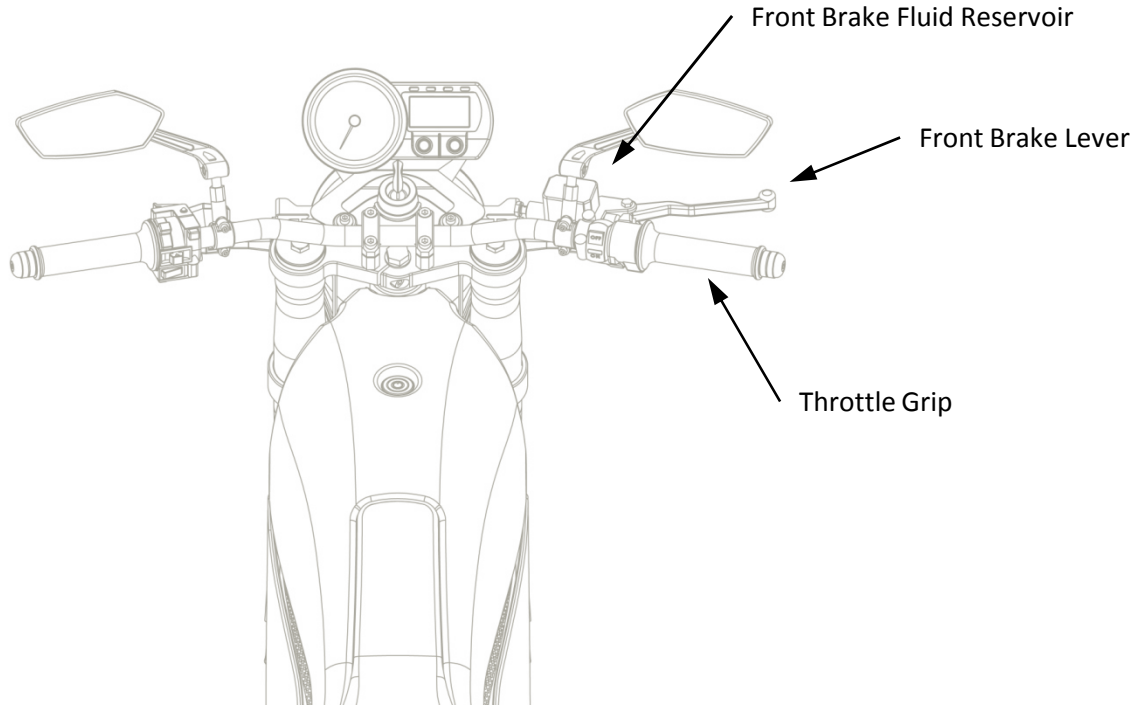

# Maintenance Component Locations

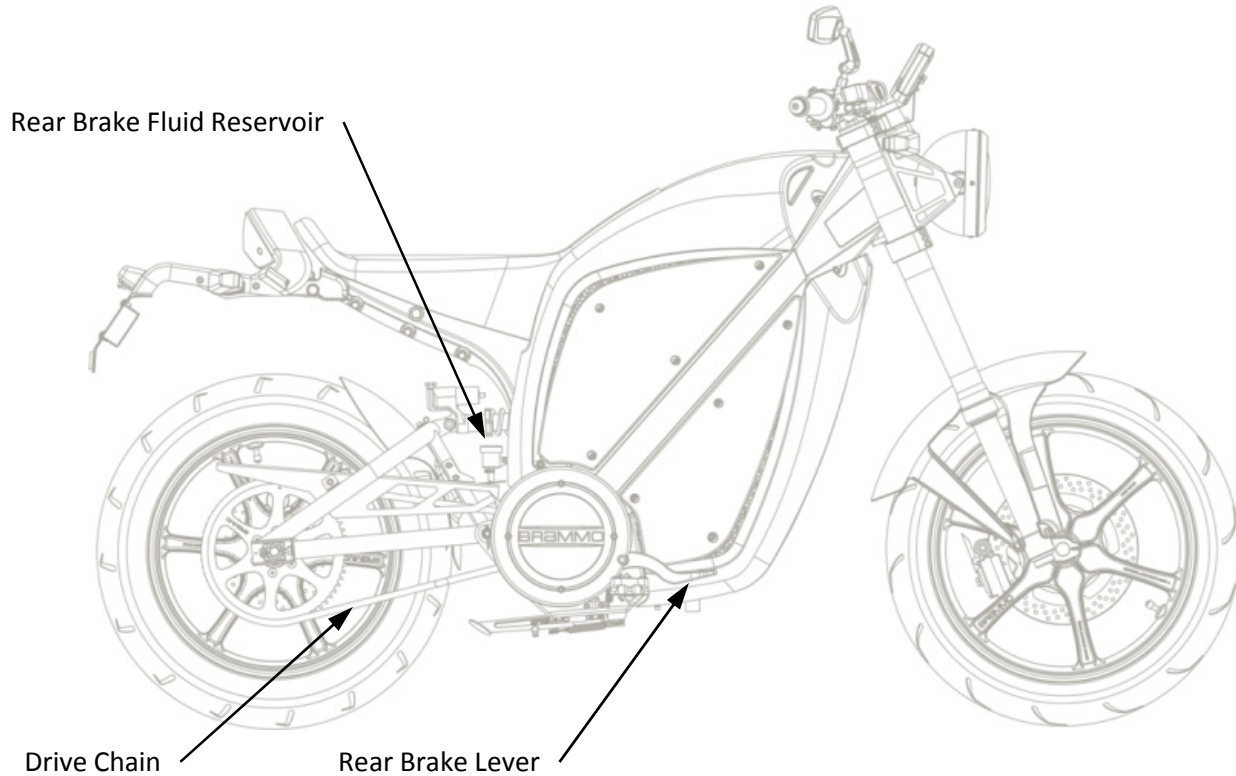

# Maintenance Component Locations

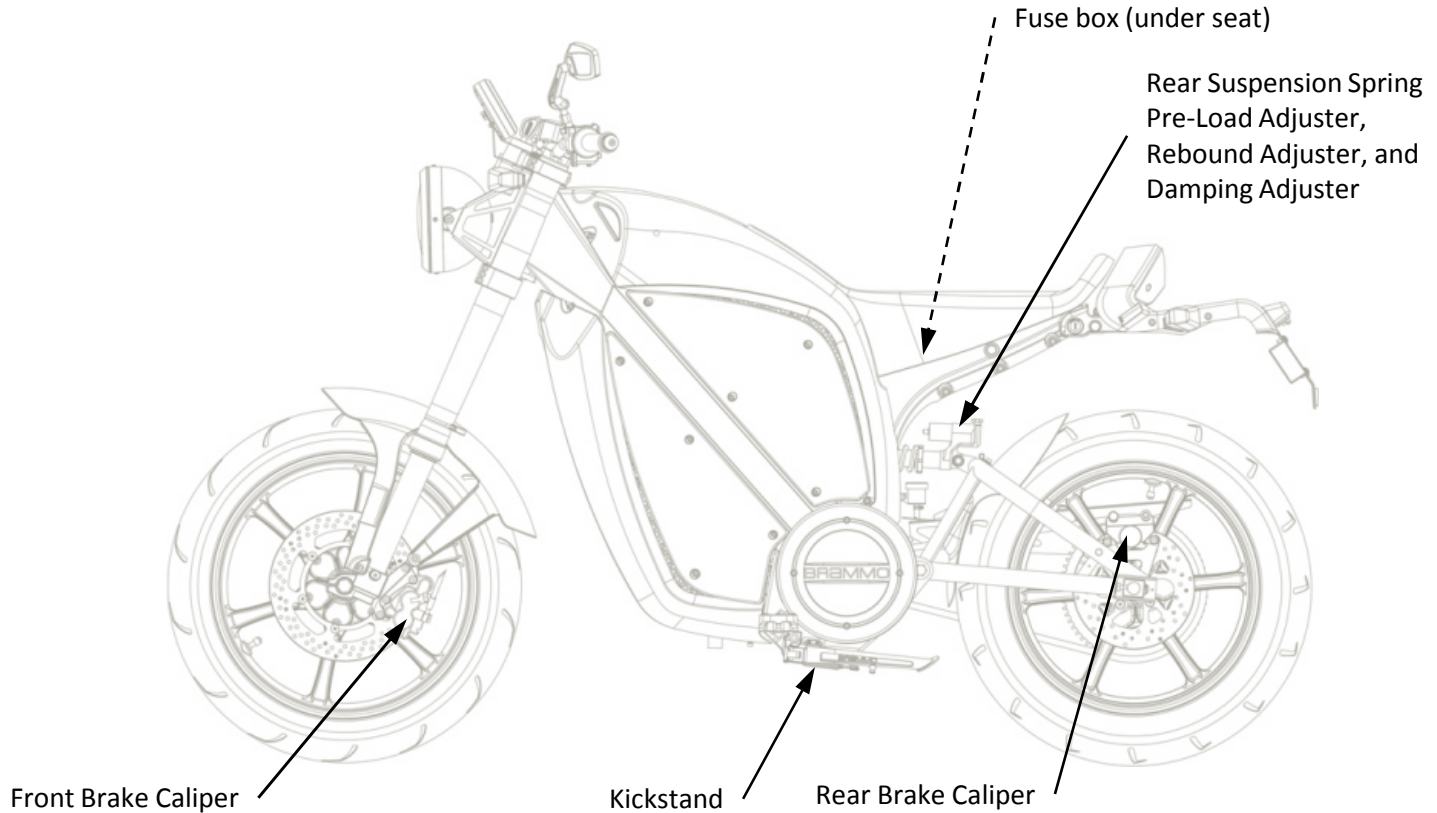

# Under the Seat

Your Enertia provides storage space under the seat for your owner's manual, legal documents, and charge cord. Additionally the fuse box, A/C power entry connector, and the USB data storage are located under the seat.

## Seat Removal

To remove the seat:

1. Insert key into seat lock (located on the left-hand at the rear of seat).
2. Turn key clockwise to unlock.
3. Lift rear of seat and remove.
4. Turn key counterclockwise to remove.



Unlock Seat Latch



Lift Seat



Remove Seat

## Replacing Seat

To replace seat:

1. Insert key into seat lock and turn clockwise.
2. Insert seat tongue into upper body panel.
3. Position seat on frame ensuring that the seat pin catches the seat hook.
4. Push on rear of seat and turn key counterclockwise to lock.
5. Remove key.

## Under the Seat

### A/C Power Entry Connector (IEC C20)

Plug in the A/C power cord to this connect to charge your Enertia. Connector is rated for 16 amps.

### A/C Power Cord (NEMA 5-20P to IEC C19)

Plug into a standard wall outlet and the A/C Power Entry Connector to charge your Enertia. Cord is rated at 16 amps. Replace only with an IEC C19 to NEMA 5-20P Power Cord.

## WARNING

The A/C Power Cord provided with your Enertia is designed to handle the high power requirements while charging. Modifying your Enertia to work with a US standard IEC C13 plug and IEC C14 receptacle could result in a fire and is not recommended as they are only rated for 10 amps.

### USB Data Storage

While riding and charging, real time diagnostic data is stored on this USB flash drive. This data can be useful while your Enertia is being serviced. The data files stored here are only readable by your BRAMMO Authorized Service Agent using specialized software.

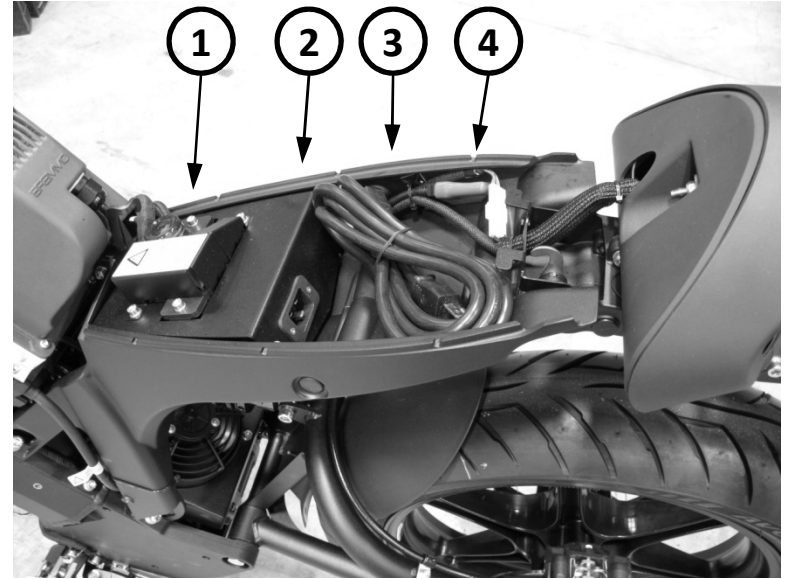

Components located under the seat

- 1) Fuse Box
- 2) A/C Power Entry Connector
- 3) A/C Power Cord
- 4) USB Data Storage

# Body Panel Removal and Installation



1. Remove the seat



2. Remove the motor covers



3. Remove the side panels



4. Remove the lower body panel



5. Remove the upper body panel



Enertia with body panels removed

The plastic body panels may need to be removed for normal inspection or service. Use the below procedure to remove all body panels:

1. Remove the seat.
2. Remove the left and right motor covers.
  - a) Using a 4mm hex driver, remove the 4 screws.
  - b) Remove the motor covers.
3. Remove the left and right side panels.
  - a) Using a 4mm hex driver, remove the 4 screws per panel.
  - b) Remove 4 side panels.
4. Remove the lower body panel.
  - a) Using a 4mm hex driver, remove the bottom screw.
  - b) Using a 4mm hex driver, remove the 2 screws near the front forks (supporting the body panel so it doesn't fall).
  - c) Carefully remove the lower body panel down and out from under the bike.
5. Remove the upper body panel.
  - a) Using a 4mm hex driver, remove the 4 screws ( 2 near the front forks and 2 near the motor cover location).
  - b) Carefully lift the upper body panel.
  - c) Disconnect the tank button and speaker connectors.
  - d) Remove the upper body panel.

To reinstall the body panels, repeat the above procedure in reverse. Torque screws to .7ft-lbs (1Nm).

# Throttle

## **Throttle Inspection** *(Refer to Safety Precautions on pages 44 & 45)*

You Enertia is equipped with a fly by wire electronic throttle. There is no throttle cable or throttle freeplay to inspect or adjust. You should inspect that the throttle assembly is secure and that it operates smoothly and freely. If the throttle assembly is loose or if there is any binding or sticking, check the following or contact your BRAMMO Authorized Service Agent.

1. Check that the throttle assembly is positioned properly and the securing screws are tight.
2. Check that the throttle housing, two nylon washers, and throttle grip are not binding and are clean of dirt and debris.
3. Check for smooth rotation of the throttle from fully open to fully closed. The throttle should snap fully closed when released from fully open.
4. Check that the throttle grip and the bar end have adequate clearance.

## **⚠ WARNING**

A sticking throttle could result in a runaway condition that could cause a crash in which you can be seriously hurt or killed. If your throttle is sticking, determine what is causing the sticking and remedy the problem before riding your Enertia.

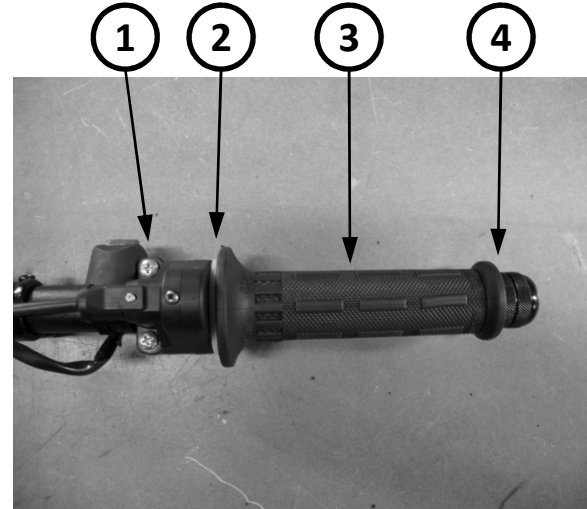

Bottom view of throttle



# Suspension

Your front and rear suspension systems use springs and hydraulic damping devices that suspend your weight and most of the weight of your Enertia.

## Front Forks

There are no user adjustments on the front forks.

## Rear Shock

You can adjust spring preload, compression damping, and rebound characteristics of the rear shock.

### (A) Spring Preload Ring

Turn the preload ring counterclockwise to decrease the preload, clockwise to increase the preload.

To adjust to standard position:

1. Raise the rear wheel off the ground using a safety stand or a hoist.
2. Loosen the 3mm set screw.
3. Turn the preload ring counterclockwise until spring is loose.
4. Turn the preload ring clockwise 4 turns.
5. Tighten the 3mm set screw to lock the preload ring.

### (B) Compression Damping Knob

Turn counterclockwise to reduce compression damping, clockwise to increase compression damping.

To adjust to standard position:

1. Turn clockwise until it will no longer turn (lightly seats).
2. Turn counterclockwise ½ turn.

### (C) Rebound Damping Screw

Turn counterclockwise to reduce Rebound Damping, clockwise to increase Rebound Damping.

To adjust to standard position:

1. Turn clockwise until it will no longer turn (lightly seats).
2. Turn counterclockwise 10 “clicks”.

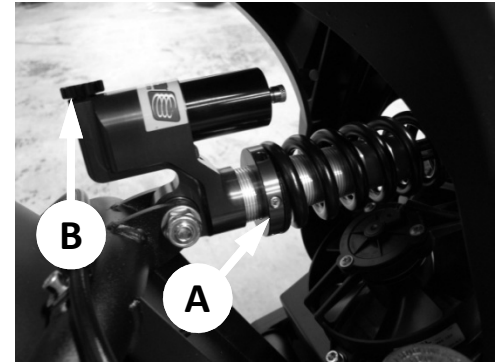

Preload Spring and Compression Damping Knob

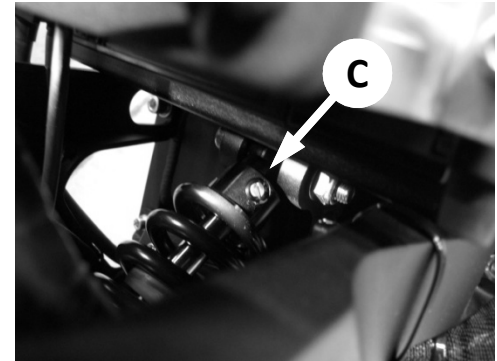

Rebound Damping Screw

## ⚠ NOTE

The rear shock is charged at the factory with a small amount of nitrogen. If you attempt to check the pressure, all of the nitrogen will escape resulting in the shock not operating properly.

# Brakes

Your Enertia is equipped with front and rear hydraulic braking systems that dissipate heat generated by the friction of the brake pads on the brake discs as the wheels are slowed. As the brake pads wear, the brake fluid levels will drop. A leak in either of the systems will also cause the level to drop. Frequently inspect the systems to ensure there are no fluid leaks. Periodically inspect the brake fluid levels and the brake pads for wear. If the brake lever or brake pedal freeplay does not feel within the normal range while riding, check the brake pads for wear. Worn pads should be replaced. If the pads are not worn beyond the recommended limit, there is probably air in the brake system. See your BRAMMO Authorized Service Agent to have the air bled from the system.

## Brake Fluid Recommendation

The recommended brake fluid is DOT 4 Brake Fluid, or any brake fluid of equal quality and performance. Use fresh brake fluid from a sealed container. Be sure to read the label before opening the sealed container. An opened container may be contaminated or may have absorbed moisture from the air.

## Fluid Level Inspection *(Refer to Safety Precautions on pages 44 & 45)*

1. Place your Enertia in an upright position on a firm, level surface.
2. Check the fluid levels of the front and rear brake fluid reservoirs. The fluid should be above the MIN marks.

If your inspection indicates a low fluid level, have your BRAMMO Authorized Service Agent add the recommended brake fluid. Do not add or replace brake fluid, except in an emergency. If you do add fluid, have your BRAMMO Authorized Service Agent check the system as soon as possible.

## Other Inspections

1. Make sure there are no fluid leaks
2. Check for deterioration or cracks in the hoses and fittings.

### **WARNING**

Brake fluid can damage plastic and painted surfaces. Handle with care. Wipe up spills immediately. Avoid contact with skin or eyes. In case of contact, wash thoroughly and call a doctor immediately if it contacts your eyes.



Front brake fluid reservoir



Rear brake fluid reservoir

# Brakes

## Brake Pad Wear *(Refer to Safety Precautions on pages 44 & 45)*

Brake pad wear depends upon the severity of usage, the type of riding, and road conditions. Generally, the pads will wear faster on wet and dirty roads. Inspect the pads at each regular maintenance interval. Always inspect both pads in each brake caliper. Always replace brake pads as a set.

## **WARNING**

During all the operations described below, the caliper oil inlet hose must NOT be disconnected.

### Front Brake Pad Inspection (MINIMUM BRAKE PAD MATERIAL THICKNESS = 1mm)

(1.) Remove the 2 pin-retaining clips. (2.) Remove the pin. (3.) Remove both brake pads. (4.) Measure the thickness of the remaining brake pad material, replace pads if thickness is less than 1mm. (5.) Reinstall pads into caliper housing, install pin, install 2 pin-retaining clips.

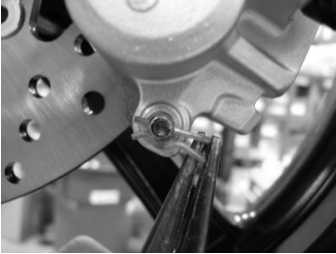

1. Remove the retaining clips



2. Remove the pin



3. Remove brake pads

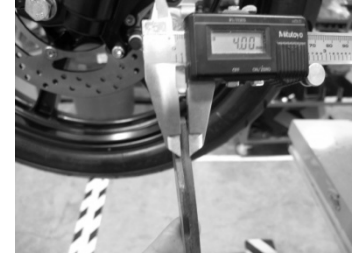

4. Measure material thickness

### Rear Brake Pad Inspection (MINIMUM BRAKE PAD MATERIAL THICKNESS = 1mm)

(1.) Remove the pin-retaining clip. (2.) Remove the pin. (3.) Unbolt caliper housing from swingarm and remove. (4.) Remove both brake pads. (5.) Measure the thickness of the remaining brake pad material, replace pads if thickness is less than 1mm. (6.) Reinstall pads into caliper housing, install caliper housing and bolt onto swingarm (torque bolts to 15 ft-lbs, 20Nm), install pin, install pin-retaining clip.

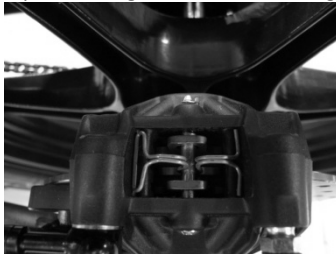

1. Remove the retaining clip

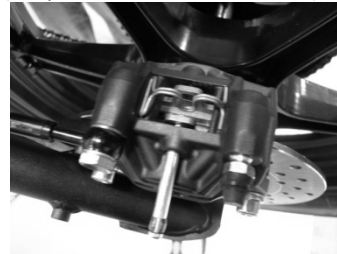

2. Remove the pin



3. Remove brake pads

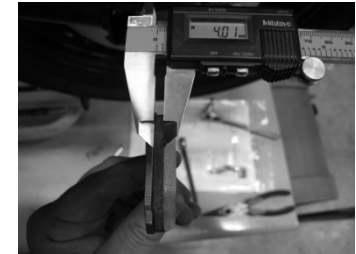

4. Measure material thickness

# Tires

To safely operate your Enertia, your tires must be the proper type and size, in good condition with adequate tread, and correctly inflated for the load you are carrying.

The following gives detailed information on how and when to check your air pressure, how to inspect your tires for wear and damage, and our recommendations for tire repair and replacement.

## Air Pressure

*(Refer to Safety Precautions on pages 44 & 45)*

Properly inflated tires provide the best combination of handling, tread life, and riding comfort. Generally, underinflated tires wear unevenly, adversely affect handling, and are more likely to fail from being overheated. Overinflated tires make your Enertia ride harshly, are more prone to damage from road hazards, and wear unevenly.

We recommend that you visually check your tires before every ride and use an air pressure gauge to measure the air pressure at least once a month or any time you think the tires might be low.

Tubeless tires have some degree of self-sealing ability if they are punctured. However, because leakage is often very slow, you should look closely for punctures whenever a tire is not fully inflated.

Always check air pressure when your tires are “cold” – after the Enertia has been parked for at least three hours. If you check air pressure when your tires are “warm” – even if your Enertia has only been ridden for a few miles – the readings will be higher. If you let air out of warm tires to match the recommended cold pressures, the tires will be underinflated.

The recommended “cold” tire pressures are:

Front	42 psi (290 kPa, 2.95 kgf/cm <sup>2</sup> )
Rear	42 psi (290 kPa, 2.95 kgf/cm <sup>2</sup> )

## WARNING

Using tires that are excessively worn or improperly inflated can cause a crash in which you can be seriously hurt or killed. Follow the instructions in this owner’s manual regarding tire inflation and maintenance.

# Tires

## Inspection

(Refer to Safety Precautions on pages 44 & 45)

Whenever you check the tire pressure, you should also look for:

- Bumps or bulges in the side of the tire or the tread. Replace any tire that has a bump or bulge.
- Cuts, slits, or cracks in the tire. Replace the tire if you can see fabric or cord.
- Nails or other foreign objects embedded in the side of the tire or tread.
- Excessive tread wear.

Also if you hit a pothole or hard object while riding, pull to the side of the road as soon as you safely can and carefully inspect the tires for damage.

## Tread Wear

For the best performance, you should replace a tire before the tread depth at the center reaches the following limits:

Front	0.06 inch (1.5 mm)
Rear	0.08 inch (2.0 mm)

## Tire Repair

We strongly recommend that you replace any tire that is punctured or damaged. A temporary repair can sometimes be made in an emergency situation. However, since a temporary repair may not hold, you must ride very slowly, and have the tire replaced or permanently repaired as soon as possible.

## Tire Replacement

The tires that came on your Enertia were designed to match the performance capabilities of your Enertia and provide the best combination of handling, braking, durability and comfort. You should replace the tires with tires of the same size, load range, and speed rating as the originals. The recommended tires for your Enertia are:

Front	100/90-18
Rear	130/80-17

Whenever you replace a tire, remember to have the wheel balanced after the tire is mounted.

## **WARNING**

Mounting improper tires on your Enertia can affect the handling and stability. This can cause a crash in which you can be seriously hurt or killed. Always use the size and type of tires recommended in this owner's manual.

# Kickstand

## Inspection

*(Refer to Safety Precautions on pages 44 & 45)*

1. Kickstand Magnet
  2. Kickstand Sensor
  3. Kickstand Spring
- Check that the kickstand assembly is working properly. If the kickstand is stiff or squeaky, clean the pivot area and lubricate the pivot pin with clean grease.
  - Check the kickstand spring for damage or loss of tension.
  - Check the kickstand system cut-off:
    1. Power up the Enertia in Drive Mode (page 31).
    2. Raise the kickstand. Drive system should be enabled.
    3. Lower the kickstand. Drive system should be disabled.

If either the drive system doesn't enable with the kickstand up or doesn't disable the drive system with the kickstand down contact your BRAMMO Authorized Service Agent for service.

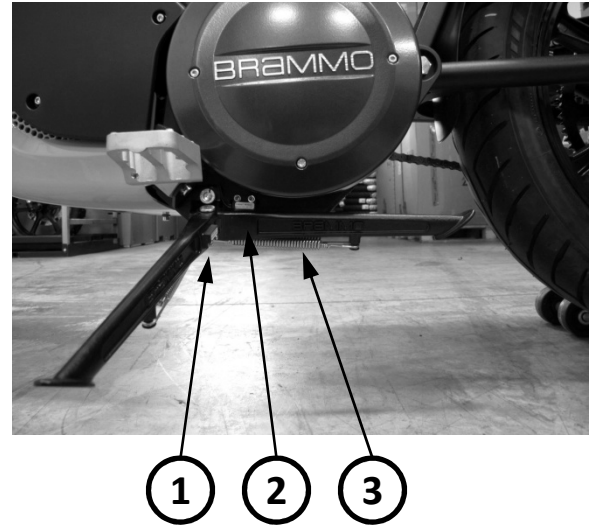

# Drive Chain

A 124 Link - 420 Standard Roller Chain connects the motor's 13 tooth sprocket to the rear wheel's 64 tooth sprocket.

The service life of the chain depends on proper lubrication and adjustment. Poor maintenance can cause premature wear or damage to the drive chain or sprockets. The drive chain should be checked, adjusted, and lubricated as part of the pre-ride inspection (page 27). Under severe usage, or when the Enertia is ridden in unusually dusty or muddy areas, more frequent maintenance will be necessary.

Before servicing your drive chain, turn the ignition switch to the OFF position, and lower the kickstand. It is not necessary to remove or replace the drive chain to perform the recommended service in the Maintenance Schedule.

## Inspection

*(Refer to Safety Precautions on pages 44 & 45)*

1. Check slack in the lower drive chain run midway between the sprockets. Drive chain slack should allow the following vertical movement by hand: **1" to 1-3/8" (25mm to 35mm)**
2. By moving the bike between inspections, check the drive chain slack at several points along the chain, always measuring it at the same point, midway between the sprockets, as shown in the photo at right.
3. Inspect the drive chain for:
  - damaged rollers
  - dry or rusted links
  - excessive wear
  - improper adjustments

Replace the drive chain (page 65) if it has damaged rollers, loose pins, or kinks that cannot be freed. Lubricate any kinked or binding links and work them free. Adjust chain slack if needed.

4. Inspect the front motor sprocket and rear wheel sprocket teeth for excessive wear or damage. If necessary, have your BRAMMO Authorized Service Agent replace a worn sprocket.



# Drive Chain

## Adjustments

(Refer to Safety Precautions on pages 44 & 45)

Drive chain slack should be checked and adjusted, if necessary, every 250 miles (400 km).

1. Place the Enertia on its kickstand with the ignition switch OFF.
2. Remove the rear axle cotter pin.
3. Using a 27mm wrench or socket, loosen the rear axle nut.
4. Loosen the lock nuts on the drive chain adjusting bolts on both sides of the swingarm.
5. Turn both the left and right drive chain adjusting bolts an equal number of turns until the correct drive chain slack is obtained. Turn the drive chain adjusting bolts counterclockwise to tighten the chain. Turn the drive chain adjusting bolts clockwise and push the rear wheel toward the front to provide more slack. Adjust the chain slack at a point midway between the front motor sprocket and the rear wheel sprocket. Roll the Enertia forward, stop and place it on its kickstand. Recheck chain slack.
6. Check the rear axle alignment by measuring the left and right side distances from the axle block to the end of the swingarm. Make the measurement from the center of the axle block to the end of the swingarm using the tooling hole as a reference. If the rear axle is misaligned, turn the right or left adjusting bolts until the distances are equal.
7. Torque the rear axle nut to: 40.6 ft-lbs (55nM). If a torque wrench is not used for this installation, see your BRAMMO Authorized Service Agent or a qualified motorcycle service shop as soon as possible to verify proper assembly. Improper assembly may lead to a loss of braking capacity.
8. Tighten the drive chain adjusting bolts lightly by turning them counterclockwise, then tighten the lock nuts by holding the drive chain adjusting bolts with a wrench.
9. Recheck drive chain slack (page 63)

## Chain Stretch

Your chain must be replaced when it reaches maximum stretch. Rear axle alignment measurements of 3/8" (9.5mm) or less (as shown in the photo to the right), indicate that the chain has been stretched to its maximum length, and must be replaced.

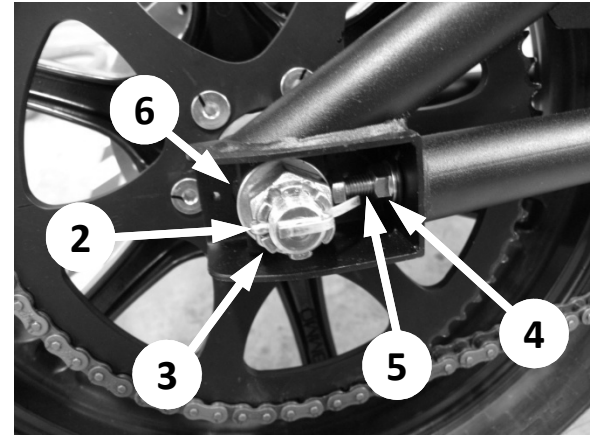

rear axle adjustment parts

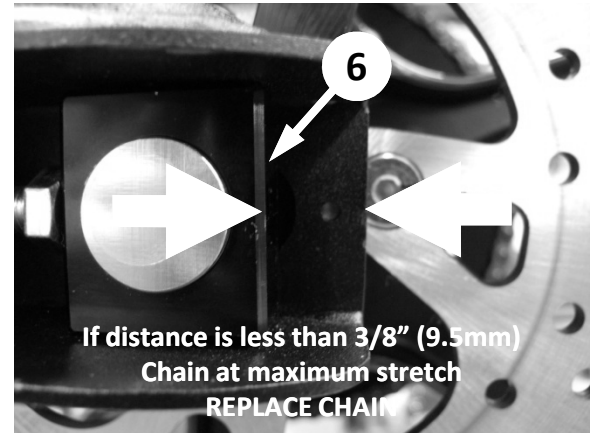

rear axle alignment measurement location



# Drive Chain

## Lubrication

(Refer to *Safety Precautions* on pages 44 & 45)

Lubricate with a high quality lubricant every 250 miles (400km), or sooner if chain appears dry. When operating in wet, hot, dry and/or dusty conditions, you may need to lubricate the chain more frequently. Apply a moderate amount so lubricant penetrates between pins, rollers and bushings.

Lubricant:

**SAE 80 or 90 Gear Oil**

**Aerosol Lubricant** designed specifically for motorcycle chains (apply as directed on can)

## Removal, Cleaning & Replacement

The chain has a clip master link that can be removed. Removal of the chain is not required for maintenance. Should you need to remove the chain for maintenance, use pliers to remove the clip, remove the master link, and then carefully remove the chain. When you reinstall the chain, verify that the closed end of the clip is facing towards the drive direction of the chain.

Clean the side surfaces of the chain with a dry cloth. Use a high flashpoint solvent such as kerosene (paraffin oil) or a biodegradable degreaser. Never use harsh solvents or chemicals, such as gasoline, to clean the chain. Never use a wire brush to clean the chain. Never use high pressure washers to clean the chain. Let the solvent dry, but make sure to lubricate the chain within 10 minutes of the solvent drying.

Replacement chain:

**DC 420HD 124L** (stock Standard Roller Chain)

or

**DC 420MO 124L** (alternate O-Ring Chain)

## WARNING

Immediately replace any chain that has come in contact with battery acid. Always immediately clean a chain after contact with rock salt or salt water. Always lubricate after cleaning.



SAE 80/90 Gear Oil



Aerosol Lubricant



Master link clip orientation

# Batteries

The Lithium Iron Phosphate battery modules used on the Enertia are maintenance free. Aside from normal charging there is no other maintenance to perform on the battery modules. The Maintenance Schedule requires Battery Inspection every 4000 miles. This is a visual inspection to verify that all battery modules are secure, the battery cable bolts are tight, and that all modules are properly charged and balanced (see Detailed Charging Information on page 41).

Inspect the battery cables verifying that all are securely attached and the bolts are tight. If you discover a loose battery cable on one of the battery modules contact your BRAMMO Authorized Service Agent.



# Appearance Care

Frequent cleaning and polishing will keep your Enertia looking newer longer. Frequent cleaning also identifies you as an owner who values your Enertia. A clean Enertia is also easier to inspect and service.

## General Recommendations

*(Refer to Safety Precautions on pages 44 & 45)*

To clean your Enertia, you may use:

- Water
- A mild, neutral detergent and water
- A mild spray and wipe cleaner/polisher
- A mild spray and rinse cleaner/degreaser and water

Avoid products that contain harsh detergents or chemical solvents that could damage the metal, paint, and plastic on your Enertia.

Park in a shady area. Washing your Enertia in bright sunlight may cause the finish to fade because water droplets intensify the sun's brightness. Spotting is also more likely because surface water can dry before you have time to wipe it off.

Clean your Enertia regularly to protect surface finishes.

We recommend the use of a garden hose to wash your Enertia. High pressure washers (like those a coin-operated car washes) can damage certain parts of your Enertia.

## Washing

- 1) Wash your Enertia with a sponge or a soft towel, mild detergent, and plenty of water.
- 2) Use care when cleaning the matte plastic parts (dash, fenders, and side panels) because they can scratch easier than the other parts of your Enertia.
- 3) After washing, rinse your Enertia thoroughly with plenty of clean water to remove any detergent residue.
- 4) Dry your Enertia with a chamois or a soft dry towel.
- 5) Use a spray cleaner/polish or a quality liquid or paste wax on the painted body panels. (apply according to the container instructions)
- 6) Touchup any chipped paint or scratches. (contact your BRAMMO Authorized Service Agent for touchup paint)
- 7) After cleaning, inspect for damage, wear, and leaks.
- 8) Lubricate the chain to prevent rusting.
- 9) As a precaution, ride your Enertia at a slow speed and apply the brakes several times. This will help dry the brakes and restore normal braking.

## NOTICE

High pressure water (or air) can damage certain parts of you Enertia.

# Appearance Care

Enertia Condition	Recommended Cleaning
Dust and fingerprint smudges.	Apply a spray cleaner/polish and wipe.
Light road grime.	Spray any difficult-to-reach or very dirty areas with a spray cleaner/degreaser. Rinse and dry. Apply a spray cleaner/polish and wipe with a non-abrasive cloth.
Heavy grime. Brake dust.	Use a spray cleaner/degreaser. If necessary, rub with a sponge. Rinse and dry. Apply a spray cleaner/polish and wipe with a non-abrasive cloth.

## Painted Aluminum Wheel Maintenance

Aluminum may corrode from contact with dirt, mud, or road salt. Clean the wheels after riding through any of these substances. Use a wet sponge and mild detergent. Avoid stiff brushes, steel wool, or cleaners containing abrasives or chemical compounds.

After washing, rinse with plenty of water and dry with a clean cloth.

If the paint is chipped, apply touch-up paint.

## Matte Surfaces

Use a soft cloth or sponge, plenty of water, and mild detergent to clean the matte surfaces. Dry with a soft, clean cloth.

Do not use polishing compounds or wax containing polishing compounds on these surfaces. These can damage or discolor the surface.

# Storing Your Evertia

If you won't be riding for an extended period, such as during the winter, thoroughly inspect your Evertia and correct any problems before storing it. That way, needed repairs won't be forgotten and it will be easier to get your Evertia running again.

We suggest you perform the following procedures to keep your Evertia in top condition. These storage procedures will reduce the deterioration that can occur during storage.

## Preparation for Storage

1. Wash and dry your Evertia. Wax all painted surfaces (except matte surfaces).
2. Lubricate the drive chain (page 65).
3. Inflate the tires to their recommended pressures (page 60).
4. Fully charge the bike (page 39).
5. Store your Evertia in an unheated area, free of dampness, away from sunlight, with a minimum of daily temperature variation.
6. Place your Evertia on blocks to lift both tires off the floor.
7. Cover your Evertia with a porous material. Avoid using plastic or similar non-breathing materials that restrict air flow and allow heat and moisture to accumulate.

If possible, fully charge the bike at least once every (3) three months during storage.

## Removal from Storage

1. Uncover and clean your Evertia
2. Fully charge the bike (page 39).
3. Lubricate the drive chain (page 65).
4. Perform a pre-ride inspection (page 27), then test-ride your Evertia at low speeds.

# Transporting Your Enertia

If your Enertia needs to be transported, it should be carried on a motorcycle trailer, or a truck or trailer with a flatbed area. Do not tow your Enertia.

When contacting a towing or transporting service, be sure to ask if they have a flatbed area, a loading ramp or power ramp to safely lift the Enertia. Also ask if they have motorcycle tie-down straps.

Use tie-down straps over each lower triple clamp to secure your Enertia. Tighten the tie-down straps until the front forks are compressed. Do not fully compress the forks as this may damage the forks.



Using tie-down straps to secure your Enertia for transport

# Taking Care of the Unexpected

This section discusses the more common problems that can occur with your Enertia while you're riding. It tells you how to evaluate each problem and what action you can take to try to resume riding. If the problem cannot be safely solved, this section also gives instructions on the proper way to have your Enertia transported.

## General Guidelines

Keeping your Enertia well-maintained is the best way to reduce the possibility of having a problem on the road.

Remember to take along your owner's manual and any other items that might help you solve a problem on your own (4mm hex driver, Emergency tire repair kit).

Should you ever have a problem while riding, please follow these guidelines:

- Always put personal safety first.
- Take time to assess the situation and your options before deciding what to do.
- If the problem is relatively minor and you have the tools, supplies, and skills to make a temporary repair, be sure to have permanent repairs made as soon as possible.
- Do not continue riding if you are hurt or your Enertia is not in safe riding condition

Additional recommendations for specific problems follow.

# If You Have a Flat Tire

A flat tire is always unwelcome, especially if you are far from help. If you think you are losing air, or you hit a pothole or hard object, pull safely to the side of the road so you can inspect the tires and assess the situation (Be sure to park on a firm, level surface and use the kickstand for support). You should examine the tire treads and sidewalls for foreign objects or damage. If you find a tire that has been punctured or damaged, you have two options.

1. Option 1 Have Your Enertia Transported – If a tire has a major puncture or a cut in the tread or sidewall, or the bead has come loose from the rim, there is probably not much you can do except have your Enertia transported to a BRAMMO Authorized Service Agent or other qualified service facility. Even with a simple puncture, this may be the safest and least troublesome solution. For transporting instructions, see page 70.
2. Option 2 Make a Temporary Roadside Repair – If a tire has only a minor nail puncture and is not completely flat, you may be able to make an emergency repair that could allow you to continue riding to where you can get the tire replaced or permanently repaired.

Due to the uncertainty of any temporary repair, you should ride slowly (not over 30 mph, 50 km/h) and carefully until the tire is replaced or permanently repaired. If the tire is losing pressure, it may be unsafe to continue riding. As the tire gets low, it will affect the handling of your Enertia, and it may overheat and blow out.

## Should You Repair or Replace a Tire?

We strongly recommend that you replace, not permanently repair, any tire that is punctured or damaged, even if the tire has only a minor puncture. For a full discussion of repairs and replacement, see page 60.

## WARNING

Riding your Enertia with a temporary tire repair can be risky. If the temporary repair fails, you can crash and be seriously injured or killed.

If you must ride with a temporary tire repair, ride slowly and carefully and do not exceed 30 mph (50km/h) until the tire is permanently repaired or replaced.



# If You Have a Flat Tire

## Emergency Front Wheel Removal/Installation

*(Refer to Safety Precautions on pages 44 & 45)*

We recommend wheel removal be done only by your BRAMMO Authorized Service Agent or another qualified mechanic. Do not attempt to remove the wheel on your own. Wheel removal requires mechanical skill and professional tools.

### Removal

1. Park your Enertia on a firm, level surface.
2. Support the Enertia securely and raise the front wheel off the ground using a safety stand or a hoist.
3. Remove the axle bolt (3).
4. Loosen the 4 axle pinch (4&5) bolts.
5. Remove the axle (6) and wheel.
6. Avoid depressing the front brake lever.

### Installation

1. Position the wheel and insert the front axle (6).
2. Verify that the axle is fully seated, torque the 2 right side pinch bolts (5) to 4.5ft-lbs (6.1Nm).
3. Install and torque the axle bolt (3) to 40.6 ft-lbs (55Nm).
4. Torque the left side pinch bolts (4) to 4.5ft-lbs (6.1Nm).

If a torque wrench was not used for installation, see your BRAMMO Authorized Service Agent as soon as possible to verify proper assembly. Improper assembly may lead to loss of braking capability.

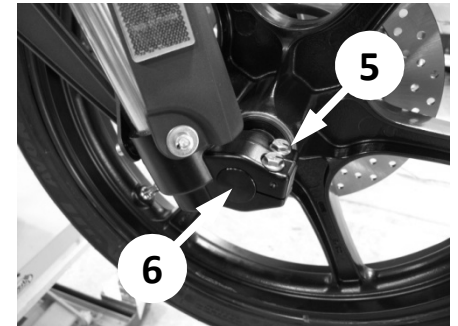
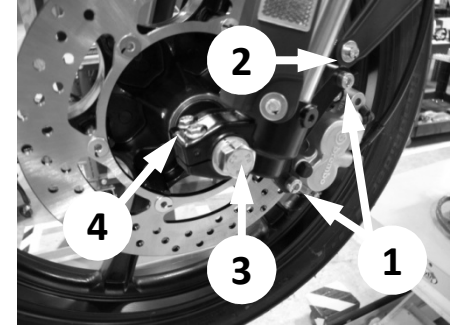

# If You Have a Flat Tire

## Emergency Rear Wheel Removal/Installation

(Refer to Safety Precautions on pages 44 & 45)

We recommend wheel removal be done only by your BRAMMO Authorized Service Agent or another qualified mechanic. Do not attempt to remove the wheel on your own. Wheel removal requires mechanical skill and professional tools.

### Removal

1. Park your Enertia on a firm, level surface.
2. Support the Enertia securely and raise the rear wheel off the ground using a safety stand or a hoist.
3. Remove the 2 caliper fixing bolts (1) and then carefully remove the caliper assembly from the disc. Support the caliper assembly once removed. Do not twist the brake hose. Avoid getting grease, oil, or dirt on the disc or pad surfaces. Avoid depressing the front brake lever.
4. Remove the cotter pin and then loosen the rear axle nut (2).
5. Loosen the drive chain lock nuts (3) and then turn the drive chain adjusting bolts so the rear wheel can be moved all the way forward for maximum drive chain slack.
6. Remove the drive chain (4) from the rear wheel sprocket by pushing the rear wheel forward.
7. Remove the axle nut, washer and axle block (5).
8. Remove the rear axle (6) and wheel.

### Installation

1. While positioning the rear wheel, carefully fit the brake disc between the brake pads to avoid damage to the pads.
2. Insert the rear axle (5) from the left side of the swingarm, through the wheel, and through the right side of the swingarm and right axle block.
3. Install the drive chain by pushing the rear wheel forward.
4. Install the rear axle nut and washer and tighten the drive chain adjusting bolts. Refer to drive chain adjustment (page 64).
5. Torque the rear axle nut to 40.6 ft-lbs (55Nm) and install
6. Install the brake caliper, install the 2 caliper fixing bolts (1), torque to 15ft-lbs (20Nm).
7. After installing the wheel, apply the brakes several times, verify that are working properly.

If a torque wrench was not used for installation, see your BRAMMO Authorized Service Agent as soon as possible to verify proper assembly. Improper assembly may lead to loss of braking capability.

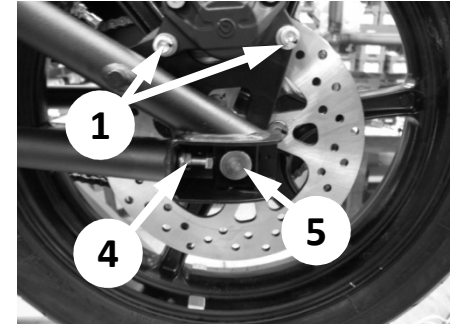
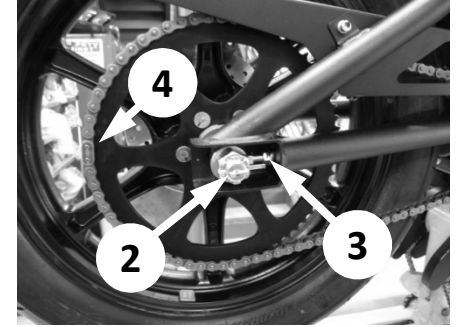

# If a Fuse Blows

## Fuse Box

All of the electrical circuits on your Enertia have fuses to protect them from damage caused by excess current flow (short circuit or overload).

If something electrical stops working, the first thing you should check for is a blown fuse. Determine from the diagram to the right which fuse or fuses control that component. Check those fuses. Replace any blown fuses and check component operation.

## Recommended Replacement Fuses

BMS, Turnlights, Horn	Pink	4A/32V MINI FAST-ACT
Brakelight	Tan	5A/32V MINI FAST-ACT
VCU/Charger, Motor Fan	Brown	7.5A/32V MINI FAST-ACT
Headlight	Red	10A/32V MINI FAST-ACT

⚠ HAZARDOUS VOLTAGE – USE EXTREME CAUTION ON THE BELOW FUSES

Controller	Pink	4A 125V MINI
72V IN	Brown	7.50A 125V MINI

## ⚠ WARNING

To avoid electrical shock, disconnect the **Blue Battery Safety Disconnect** before replacing the high voltage fuses.

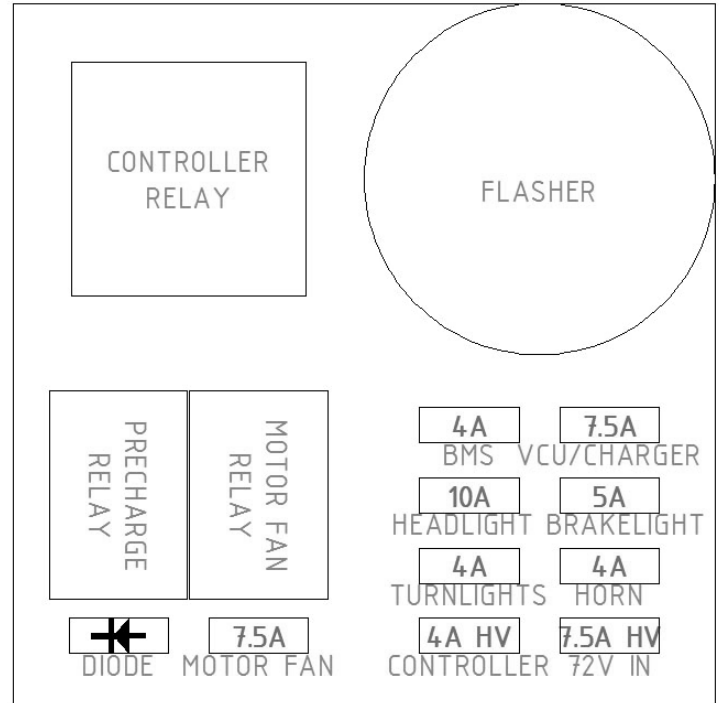

Fusebox fuses and components

## If You Crash

Personal safety is your first priority after any accident. If you or anyone else has been injured, take time to assess the severity of the injuries and whether it is safe to continue riding. Call for emergency assistance if needed. Also follow applicable laws and regulations if another person or vehicle is involved in the accident.

If you decide you are capable of riding safely, carefully inspect your Enertia for damage and determine if it is safe to ride. Check the tightness of critical nuts and bolts securing such parts as the handlebar, control levers, brakes, and wheels.

If there is minor damage, or you are unsure about possible damage, ride slowly and cautiously. Sometimes, crash damage is hidden or not immediately apparent, so you should have your Enertia thoroughly checked at a qualified service facility as soon as possible. Also, be sure to have your BRAMMO Authorized Service Agent check the frame and suspension after any serious crash.

If your Enertia cannot be ridden, see *Transporting Your Enertia*, page 70

## If You Lose Your Key

Your Enertia has an onboard security system that is coded to the transponders in each of your keys. The (2) two keys that came with your Enertia are the only keys that will power your bike up. BRAMMO recommends that you keep one spare in a safe location in case you misplace the other.

If one or both keys are lost, contact your BRAMMO Authorized Service Agent for replacement options.



# System Warning and Error Codes

Your Enertia has the ability to detect warning and error conditions. These warnings and errors are designed to alert you the rider that a condition exists that is out of specification. Most of the of these warnings and errors will require a BRAMMO Authorized Service Agent to diagnose your Enertia. However some issues can be addressed by you, either by correcting the issue or by changing your riding style. Below is a list of various codes and what they mean.

Dash Warning Message	Warning / Error Description (System Action Taken)	User Action
CONNECT POWER	AC Not Connected (Shutdown after 1 minute if no AC)	Connect AC Power
DISCONNECT POWER	AC Connected (Disable Drive)	Disconnect AC Power
ALLOW COOLDOWN B35	Battery Fault: Over Temperature Shutdown (Disable Drive or Charge; BMS opens Contactor)	Allow Enertia to Cool
ALLOW COOLDOWN B36	Battery Fault: Over Temperature Alarm (Disable Drive; BMS opens Contactor)	Allow Enertia to Cool
ALLOW COOLDOWN B56	Battery Fault: Over Temperature Warning	Allow Enertia to Cool
ALLOW COOLDOWN B60	Battery Fault: 120A Over Current Warning	Reduce Throttle
ALLOW COOLDOWN B61	Battery Fault: 150A Over Current Warning	Reduce Throttle
ALLOW COOLDOWN B62	Battery Fault: 200A Over Current Warning	Reduce Throttle
ALLOW COOLDOWN B63	Battery Fault: 250A Over Current Warning	Reduce Throttle
ALLOW COOLDOWN B64	Battery Fault: 300A Over Current Warning	Reduce Throttle
BATTERIES LOW	Battery Fault: BMS SOC < 20%	Charge Batteries
RECHARGE REQUIRED B30	Battery Fault: Critically discharged alarm (BMS opens contactor)	Charge Batteries
RECHARGE REQUIRED B33	Charge (SOC) is at 0%	Charge Batteries
RECHARGE REQUIRED B53	Battery Fault: Critically discharged warning	Charge Batteries
SERVICE REQ'D B28	Battery Fault: Voltage Sensor Failure	Contact BRAMMO Service
SERVICE REQ'D B29	Battery Fault: Current Sensor Failure	Contact BRAMMO Service
SERVICE REQ'D B31	Battery Fault: Over Volt alarm (BMS opens contactor; disable drive or charge)	Contact BRAMMO Service
SERVICE REQ'D B32	Battery Fault: Sanity Error (No communication) (Disable Drive or Charge)	Contact BRAMMO Service
SERVICE REQ'D B41	Battery Fault: insulation measurement failed	Contact BRAMMO Service
SERVICE REQ'D B42	Battery Fault: 120A Over Current Alarm	Reduce Throttle
SERVICE REQ'D B43	Battery Fault: 150A Over Current Alarm	Reduce Throttle
SERVICE REQ'D B44	Battery Fault: 200A Over Current Alarm	Reduce Throttle
SERVICE REQ'D B47	Battery Fault: 250A Over Current Alarm	Reduce Throttle
SERVICE REQ'D B48	Battery Fault: 300A Over Current Alarm	Reduce Throttle
SERVICE REQ'D B54	Battery Fault: Over Volt warning	Contact BRAMMO Service
SERVICE REQ'D B55	Battery Fault: SOC Mismatch > 30%	Contact BRAMMO Service
SERVICE REQ'D B7	Battery Fault: Module Lost (Disable Drive or Charge; BMS opens contactor in 15 seconds; )	Contact BRAMMO Service
SERVICE REQ'D B8	Battery Fault: Temperature Sensor Failure	Contact BRAMMO Service
SERVICE REQ'D B40	Battery Fault: BMS Back in Idle Mode	Contact BRAMMO Service
SERVICE REQ'D B6	BMS Not Communicating (Disable Drive or Charge)	Contact BRAMMO Service
SERVICE REQ'D B99	BMS Manufacturer ID wrong (Disable Drive or Charge)	Contact BRAMMO Service
COOLDOWN CYCLE C65	Charger Temperature Too High	Allow Enertia to Cool
SERVICE REQ'D C2	Charger Fault (Disable Drive or Charge; Shutdown after 30 seconds)	Contact BRAMMO Service
Dash Not Functioning	Dash not connected, or not working (Tank LED Fast Blink)	Contact BRAMMO Service
SERVICE REQ'D I51	Dash Power Current Too High (Tank LED Fast Blink (in case no display))	Contact BRAMMO Service
COME TO FULL STOP	Vehicle Speed not zero when throttle switch turned on	Come to Full Stop
CYCLE THROTTLE SW	DMC Footswitch Sequence Error	Turn ON/OFF Switch OFF
SERVICE REQ'D D4	DMC Not Communicating (Disable Drive )	Contact BRAMMO Service
SERVICE REQ'D H52	Motor Controller Fan Power Overcurrent	Contact BRAMMO Service
SERVICE REQ'D D10	DMC Direction Selection Error (Disable Drive )	Contact BRAMMO Service

Dash Warning Message	Warning / Error Description (System Action Taken)	User Action
SERVICE REQ'D D11	DMC Seat or Tiller Switch not closed (Disable Drive)	Contact BRAMMO Service
SERVICE REQ'D D14	DMC Forbidden Input Selected (Disable Drive)	Contact BRAMMO Service
SERVICE REQ'D D15	DMC Internal 12V Supply Too Low (Disable Drive)	Contact BRAMMO Service
SERVICE REQ'D D17	DMC Battery Voltage Too Low (Disable Drive)	Contact BRAMMO Service
SERVICE REQ'D D18	DMC High Side Mosfet Error in neutral or while pulsing (Disable Drive)	Contact BRAMMO Service
SERVICE REQ'D D19	DMC Low Side Mosfet error while pulsing (Disable Drive)	Contact BRAMMO Service
SERVICE REQ'D D20	DMC Motor Over-Current (Disable Drive )	Contact BRAMMO Service
SERVICE REQ'D D21	DMC Contactor Coil Error (Disable Drive)	Contact BRAMMO Service
SERVICE REQ'D D22	DMC Battery Voltage Too High (Disable Drive)	Contact BRAMMO Service
SERVICE REQ'D D23	DMC Low side Mosfet error in Neutral (Disable Drive)	Contact BRAMMO Service
SERVICE REQ'D D24	DMC Controller error or contactor coil error (Disable Drive)	Contact BRAMMO Service
SERVICE REQ'D D25	DMC Contactor Error (Disable Drive)	Contact BRAMMO Service
SERVICE REQ'D D26	DMC Controller Error (Disable Drive)	Contact BRAMMO Service
SERVICE REQ'D D27	DMC Low Side Mosfet error before contactor closed (Disable Drive)	Contact BRAMMO Service
SERVICE REQ'D D28	DMC Wig Wag wire off error (Disable Drive)	Contact BRAMMO Service
SERVICE REQ'D D29	DMC CAN error (Disable Drive)	Contact BRAMMO Service
SERVICE REQ'D D30	DMC Over speed or encoder error (Disable Drive)	Contact BRAMMO Service
SERVICE REQ'D D31	DMC – One or more motor sensor wires not connected (Disable Drive)	Contact BRAMMO Service
SERVICE REQ'D D32	DMC – The motor speed sensor mechanically loose (Disable Drive)	Contact BRAMMO Service
SERVICE REQ'D D33	DMC @ demand 0 drive current > 50A. In Braking the current must be negative (Disable Drive)	Contact BRAMMO Service
SERVICE REQ'D D7	DMC Out of Range programming (Disable Drive)	Contact BRAMMO Service
SERVICE REQ'D D9	DMC Internal Memory Error (Disable Drive)	Contact BRAMMO Service
THERMAL CUTBACK D6	DMC Temperature Too High	Allow Enertia to Cool
CYCLE THROTTLE SW.	Throttle Switch on at power up	Turn ON/OFF Switch OFF
GET SERVICE H73	USB Flash Drive bad or removed	Contact BRAMMO Service
SERVICE REQ'D H34	Discharge "pre-Charge" error (Disable Drive)	Contact BRAMMO Service
TWIST THROTTLE TO 0	DMC Accelerator deflected at power up	Turn Throttle to Close
HEADLIGHT OFF	Headlights off in Drive Mode (Disable Drive)	Turn ON Headlight
KICKSTAND DOWN	Kickstand is down (Disable Drive)	Put Kickstand Up
THERMAL CUTBACK D5	Motor Temperature Too High	Allow Enertia to Cool
SERVICE MODE	Diagnostic Cable Connected	Contact BRAMMO Service
GET SERVICE V70	USB interface failure	Contact BRAMMO Service
GET SERVICE V71	USB Flash Power Fail	Contact BRAMMO Service
GET SERVICE V72	VCU Temperature Vref out of spec. (Display temperature as 0)	Contact BRAMMO Service
GET SERVICE V77	Sound Failure	Contact BRAMMO Service
GET SERVICE V78	Real Time Clock Not Working	Contact BRAMMO Service
Dash Not Functioning	Dash CAN Processor Failure (Tank LED Fast Blink)	Contact BRAMMO Service
SERVICE REQ'D V1	VCU Temperature Too High (Disable Drive or Charge; Shutdown after 30 seconds)	Contact BRAMMO Service
SERVICE REQ'D V3	BMS CAN processor failure (Disable Drive or Charge)	Contact BRAMMO Service
SERVICE REQ'D V4	DMC CAN processor failure (Disable Drive or Charge)	Contact BRAMMO Service
SERVICE REQ'D V58	VCU +12V Out of Spec	Contact BRAMMO Service
SERVICE REQ'D V59	VCU +5V Out of Spec	Contact BRAMMO Service
SERVICE REQ'D V69	SPI Flash Memory Failure	Contact BRAMMO Service
TWIST THROTTLE TO 0	Accelerator Deflected, should be in Idle	Turn Throttle to Close

# Technical Information

This section contains dimensions, capacities, and other technical data, plus information on government requirements.

## Serial Numbers

The VIN and motor serial number are required when you register your Enertia. They may also be required when ordering replacement parts. You may record these numbers in the Quick Reference section at the rear of this manual.

The VIN (vehicle identification number) is appears on the Safety Certification Label attached to the right side of the frame.



Safety Certification Label

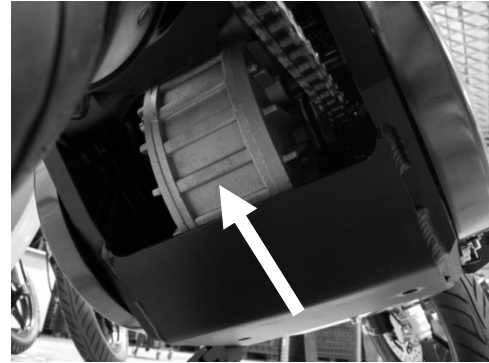

Motor Serial Number

The motor serial number is stamped on the rear of the motor case.

# Specifications

<b>Dimensions</b>	
Overall Length	2070 mm (81.5 in)
Overall Width	838.2 mm (33 in)
Over Height	1380 mm (54.3 in)
Wheelbase	1422.4 mm (56 in)
Ground Clearance	140 mm (5.5 in)

<b>Lubricants</b>	
Drive Chain	SAE 80 or 90 gear oil

<b>Capacities</b>	
Passenger Capacity	Operator ONLY
Maximum Weight Capacity	125 kg (276 lbs) rider, all cargo, accessories

<b>Motor Specifications</b>	
Power	7.0 Kilowatts (9.39 HP)
Torque	8.19 ft/lb (11.1Nm)
Speed	4500 RPM
Voltage	55.5 VAC
Current	90 A

<b>Power Transmission</b>	
Drive (Motor) Sprocket	14 Tooth
Driven (Rear Wheel) Sprocket	64 Tooth
Chain	DC 420HD 124L (stock Standard Roller Chain) DC 420MO 124L (alternate O-Ring Chain)



# Specifications

<b>Chassis &amp; Suspension</b>	
Caster	24°
Trail	89 mm (3.5 in)
Tire Size, Front	100/90-18 Avon - AM26 Roadrider Front/Rear Tire 100/90V-18
Tire Size, Rear	130/80-17 Avon - AM26 Roadrider Front/Rear Tire 130/80V-17
Tire Type	Radial, Tubeless
Tire Pressure, Front (cold)	42 psi (290 kPa, 2.95 kgf/cm <sup>2</sup> )
Tire Pressure, Rear (cold)	42 psi (290 kPa, 2.95 kgf/cm <sup>2</sup> )

<b>Batteries</b>	
Main Battery Modules (6)	12.8V 40Ahr 512Whr Lithium Iron Phosphate (3.072 KWhr total)

<b>Lights</b>	
Headlight	H4 Halogen 55/60W Bulb
Brake/Tail Light	1157 12V 21/5W Bulb
Turn Signal Lights	916 12V 18W Bulb
License Light	C5W 12V 5W Bulb

<b>Fuses</b>	
BMS, Turnlights, Horn	4A/32V MINI FAST-ACT
Brakelight	5A/32V MINI FAST-ACT
VCU/Charger, Motor Fan	7.5A/32V MINI FAST-ACT
Headlight	10A/32V MINI FAST-ACT
Controller	4A 125V MINI
72V IN	7.50A 125V MINI

# Warranty Coverage

## **BRAMMO Warranty**

BRAMMO warrants the Enertia under the terms of the owner's manual during the applicable warranty period from any defects in material and workmanship. If any such defect should be found within the applicable warranty period, BRAMMO has appointed a BRAMMO Authorized Service Agent near you for the servicing of those products and parts under the manufacturer's warranty. The BRAMMO Authorized Service Agent will perform warranty services on the Enertia after first ascertaining that the product is under warranty. Acceptable proofs of purchase for the purpose of establishing your warranty period include receipts issued to the customer at the time of sale from an approved BRAMMO dealer (such as invoiced or credit card receipts) or data retrieved from the BRAMMO Authorized Service Agent's electronic records. Acceptable proofs of purchase must contain the date of purchase of the product and a description of the product.

## **BRAMMO's Warranty Obligation**

If any defect in material or workmanship should be found within the applicable BRAMMO warranty period specified in this booklet, BRAMMO's only obligation is to have the defect either repaired or replaced, at BRAMMO's option, with a new part or the equivalent without charge for parts and labor, at a authorized dealer if such defect is attributable to faulty material or workmanship at the time of manufacture. All parts removed under this limited warranty become the property of BRAMMO. At BRAMMO's sole option, warranty service may be made by replacing a larger component of which the defect is part, or with the owner's permission by replacing the vehicle. The owner is responsible for any repairs or replacements which are not covered by this limited warranty. BRAMMO reserves the right to make improvements to, and/or change the design of any model at any time without obligation to make the same improvements or changes to models previously sold.

## **LIMITATION OF LIABILITY**

TO THE FULLEST EXTENT PERMITTED BY LAW, THE PRECEDING WARRANTY IS THE ONLY WARRANTY GIVEN BY BRAMMO FOR THE VEHICLE, AND THE VEHICLE OTHERWISE IS SOLD "AS IS". EXCEPT FOR THE WARRANTY EXPRESSLY STATED HEREIN, THE CUSTOMER AND NOT THE MANUFACTURER OR DEALER ASSUMES THE ENTIRE COST OF ALL NECESSARY SERVICING AND REPAIR SHOULD THE VEHICLE PROVED EFFECTIVE FOLLOING ITS PURCHASE, AND THE ENTIRE RISK AS TO THE QUALITY AND PERFORMANCE OF THE VEHICLE IS WITH THE CUSTOMER. BRAMMO MAKES NO OTHER WARRANTIES, EXPRESS OR IMPLIED, AND SPECIFICALLY MAKES NO WARRANTY OF MERCHANT ABILITY OR FITNESS FOR A PARTICULAR PURPOSE.

BRAMMO IS NOT RESPONSIBLE FOR DIRECT, INDIRECT, CONSEQUENTIAL, INCIDENTAL OR SPECIAL DAMAGES, INCLUDING WITHOUT LIMITATION ANY DAMAGES FROM LOSS OF USE OF THE VEHICLE. TO THE FULLEST EXTENT PERMITTED BY LAW, BRAMMO'S ENTIRE LIABILITY, WHETHER IN TORT, CONTRACT OR OTHERWISE, SHALL BE LIMITED TO REPAIR OR REPLACEMENT DURING THE APPLICABLE WARRANTY PERIOD OF DEFECTS IN MATERIAL OR WORKMANSHIP.

# Warranty Coverage

## Warranty Period

Under the regular use, the valid term of parts warranty list:

- a) General Warranty: 12months
- b) Battery Warranty: 24 months

## Items Not Covered By Warranty

The warranty shall NOT apply to:

- a) Normal maintenance and service, including, without limitation, adjustments to brakes, tire pressure and chain tension, due to wear and tear from operation the vehicle and not as a result of a defect in materials and workmanship;
- b) The replacement of normal wear parts, including without limitation, all rubber parts, bulbs, lenses, wires, cables, fuses, tires, tubes, brake lines, and chains, due to wear and tear from operation the vehicle and not as a result of a defect in materials and workmanship;
- c) Any repairs or replacements required as a result of accidents or collision;
- d) Any defects caused or repairs required as a result of abusive operation, negligence, accident, improper installation (modification) or inappropriate use as outlined in this manual;
- e) Any products tampered with, modified, adjusted or repaired by any unauthorized party including the owner;
- f) Any damage caused or resulting from the use of inappropriate tools;
- g) Any additional accessory installed by the owner which cause defect of additional parts;
- h) Any cosmetic damage to the surface or exterior;
- i) Any damage caused by external or environmental conditions such as abnormal weather, accidents, earthquake, etc;
- j) Any product received without appropriate model and frame serial number identification;
- k) Any product used for rental, or racing purposes;
- l) Failure to use vehicle in the proper manner, maintenance, storage procedure in BRAMMO owner's manual (i.e. power cycle designed for "on the road use" and used as "off road vehicle").

## Notice to Consumers

The terms contained in this limited warranty are not intended to limit, modify, take away from, disclaim or exclude any warranty which by law cannot be limited, disclaimed or excluded. To the extent that any applicable law prohibits any term contained in this warrant, such term shall be considered severable and deemed to be deleted from this warranty.

# Warranty Coverage

## **Term for Demonstrators**

For a vehicle which is used by an authorized dealer as a demonstrator, the applicable term of the manufacturer's warranty begins on the first day the vehicle is used as a demonstrator. Any remaining portion of the warranty on a demonstrator vehicle may be transferred to a subsequent retail purchaser subject to the terms, conditions and exclusions contained in this limited warranty.

## **Qualification for Warranty**

To qualify for this limited warranty:

- a) The vehicle must be removed from its shipping container, assembled and prepared for use by an authorized BRAMMO dealer; and serviced by a BRAMMO Authorized Service Agent.
- b) The sales registration card must be completed and mailed to BRAMMO within 30 days of delivery of the vehicle to the original purchaser

## **Owner's Warranty Responsibilities**

It is the responsibility of each owner to:

- a) Obtain from the authorized BRAMMO Enertia dealer from whom the vehicle was purchased;
  - I. A signed copy of the sales registration form; indicating the pre-delivery inspection has been completed in accordance with the manufacturer's instructions
  - II. The appropriate owner's manual for the model of vehicle purchased;
- b) Ensure, at his own expense, the vehicle has the maintenance service inspections specified in this owner's manual conducted by a BRAMMO Authorized Service Agent and to maintain adequate proof that such service inspections have been conducted; and,
- c) Ensure that the BRAMMO Authorized Service Agent conducting the service inspections has certified the work of the "Service" pages of this Enertia owners manual.

Please note: Your copy of the Sales Registration Form is your warranty identification document, which you may be required to present to obtain warranty service. If your warranty identification document should be lost or destroyed, consult your authorized BRAMMO Enertia dealer from whom the vehicle was purchased for instructions concerning replacement.

## **Customer Satisfaction**

Product quality and customer satisfaction are critical ingredients to the success of BRAMMO. This information is designed as a tool to help you understand how to efficiently service our products by working with an authorized dealer near you or a BRAMMO Authorized Service Agent. Should a question or problem arise concerning service and warranty which cannot be resolved by a BRAMMO Authorized Service Agent please contact BRAMMO headquarters directly. Our goal is to quickly resolve your problem. BRAMMO and a list of your nearest BRAMMO Authorized Service Agents can be located by visiting our website at [www.BRAMMO.com](http://www.BRAMMO.com). Should you have any further questions after visiting our website you can write or call: BRAMMO Inc. | 550 Clover Lane | Ashland, OR 97520 USA | Tel: 1-888-48-BRAMMO

## Reporting Safety Defects (USA only)

If you believe that your vehicle has a defect which could cause a crash or could cause injury or death, you should immediately inform the National Highway Traffic Safety Administration (NHTSA) in addition to notifying BRAMMO.

If NHTSA receives similar complaints, it may open an investigation, and if it finds that a safety defect exists in a group of vehicles, it may order a recall and remedy campaign. However, NHTSA cannot become involved in individual problems between you, your dealer, or BRAMMO.

To contact NHTSA, you may call the Vehicle Safety Hotline toll-free at:

1-888-327-4236

(TTY: 1-800-424-9153); go to:

<http://www.safercar.gov>; or write to:

Administrator, NHTSA, 1200 New Jersey Avenue, SE., Washington, DC 20590.

You can also obtain other information about motor vehicle safety from;

<http://www.safercar.gov>.

# Index (A-L)

Accessories	10	Enabling the Drive System	32
A/C Power Cord	54	Error Codes	78
A/C Power Entry Connector	54	Eye Protection	25
Appearance Care	67,68	Flat Tire	72,73,74
Are You Ready to Ride?	24,25,26	Front Wheel Removal/Installation	73
Batteries	66	Fuse Box	54,75
Battery Low/Discharged Indicator	15,17	GO Indicator	15,16
Battery Management System	38	GPS Signal Indicator	15,17
Battery Modules	38	Headlight Dimmer Switch	22
Blue Battery Safety Disconnect	45	Headlight ON/OFF Switch	22,32,35
Body Panel Removal and Installation	55	Helmets	25
Brakes	58,59	High Beam Flasher	22
Braking	33,34	High Beam Indicator	15,16
Cell Balancing	40	Horn Button	22
Chain	63,64,65	If You Crash	76
Charger	38	Ignition Switch	20,31,35,36,39,40
Charge Mode	39	Immobilizer Indicator	15,18
Charging Status Indicator	15,17	Indicator Check	19
Component Location	13,14	Key	31,77
Consumer Information	82,83,84	Kickstand	31,32,35,36,62
Detailed Charging Information	41	Kickstand Down Indicator	15,16
Display Check	19	LCD Display	15,18
Drive Enabled Indicators	15,17	Left Turn Indicator	15,16
DRIVE Mode	31	Loading Limits	28
Emissions Label	12	Low Beam Indicator	15,16

# Index (M-W)

Maintenance Component Locations	50,51,52	Safety Certification Label	12
Maintenance Record	49	Safety Labels	12
Maintenance Safety	44,45	Seat Removal	53
Maintenance Schedule	47,48	Servicing Your Enertia	42-68
Meter Check	19	Setting the Time	23
Mode Button	15,18	Speedometer	15,16
Modifications	11	Storing Your Enertia	69
Motor Controller OFF/ON Switch	21	Suspension	57
Motor Over Temperature Indicator	15,17	System Attention Indicator	15,16
Motorcycle Safety Foundation	26	System Warning	78
NHTSA	85	Tank Button	20,31
ON Indicator	15,16	Technical Information	79,80,81
Periodic Maintenance	46	Throttle	56
Powering Up	31	Tips	69,70
Preparation for Storage	69	Tires	60,61
Pre-ride Inspection	27	Transporting Your Enertia	70
Protective Apparel	25	Trip Button	15,18
Rear Wheel Removal/Installation	74	Troubleshooting	71,78
Removal from Storage	69	Turn Signal Switch	22
Replacement Fuses	75	Under the Seat	54
Reporting Safety Defects	85	USB Data Storage	54
Rider Training	26	Warranty Coverage	82,83,84
Riding Gear	25		
Right Turn Indicator	15,16		
Safety	8,9		







# Quick Reference

## Power Up the Enertia in DRIVE mode.

1. Insert Key into the Ignition Switch.
2. Turn the Ignition Switch clockwise to the ON Position.
3. Press and Hold the Tank Button.
4. Enertia will power up in the DRIVE Mode.

## Enable the Drive System and Riding the Enertia

1. Put the Kickstand Up.
2. Turn the Headlight ON.
3. Place the OFF/ON switch in the ON position.

The drive system will energize. Immediately, you will hear a small relay “click” under the seat followed by the main contactor “click” from the motor area. The “GO” indicator on the dash will illuminate and the 4 LEDs above the LCD will blink indicating that the Enertia has successfully entered a safe operational state in DRIVE MODE.

Carefully twist the throttle towards you to apply power to the motor, your Enertia will accelerate. Twist the throttle away from you to remove power from the motor, your Enertia will slow. The Enertia has no clutch or gears to operate, simply use the throttle and brakes to control your speed.

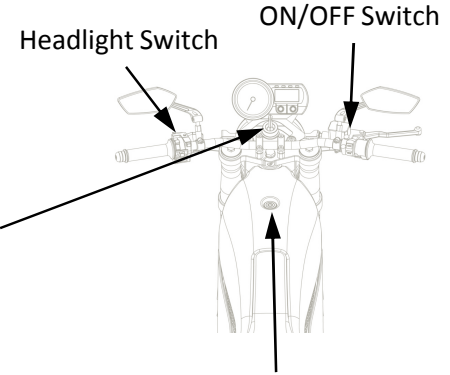
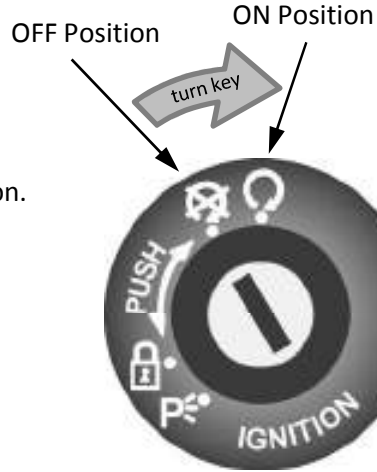

Press and Hold the Tank Button until bike powers up

## WARNING

The throttle is live, use extreme caution.

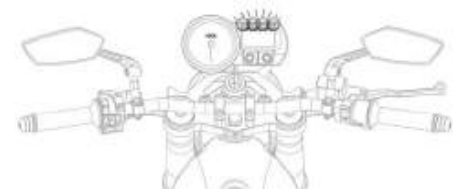

# Quick Reference

## Charging your Evertia

1. Turn the handlebar all the way to the left (or right).
2. Insert key into the ignition.
3. Push in on the key and turn it to the LOCK position (counterclockwise).
4. Release the key, then continue turning the key to the CHARGE position (counterclockwise).
5. Press and hold the Tank Button.
6. Evertia will power up in the CHARGE mode.
7. Remove the key.
8. Unlock the seat.
9. Plug the Evertia into standard A/C outlet.

After the Evertia powers up in the CHARGE mode, the dash will illuminate, all lighting and the horn will function. When A/C power is detected, the Evertia will begin to charge.

While charging, the Evertia will display the estimated charge time remaining and state of charge in percentage.

4:41PM 77°F  
CHARGING REMAINING  
1:45 HOURS  
50% COMPLETE  
CONNECT AC POWER  
ODO 6687.5 T 0.0

A/C not connected warning

4:41PM 77°F  
CHARGING REMAINING  
1:45 HOURS  
50% COMPLETE  
ODO 6687.5 T 0.0

Charging Evertia screen

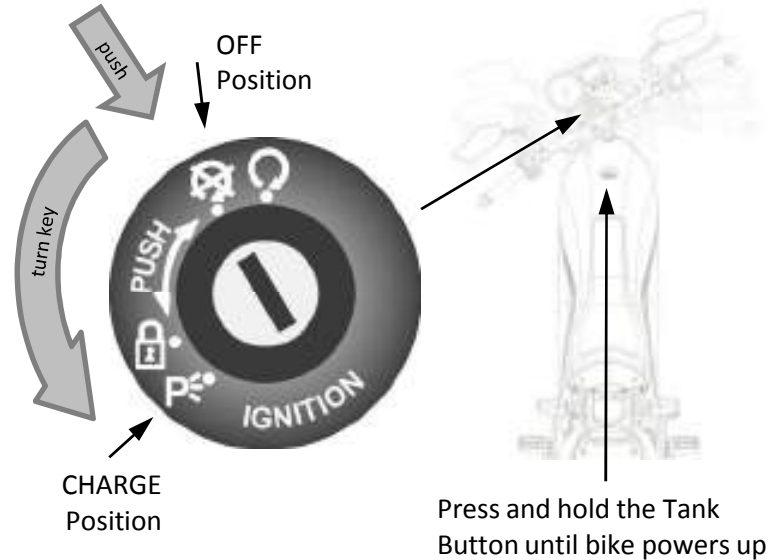

## ⚠ NOTE

The Evertia will automatically shut down in CHARGE mode if A/C power is not detected after 60 seconds. You have 60 seconds from the time the Evertia powers up in CHARGE mode to plug in the A/C power cord.

