

E-TON

Beamer & Beamer Matrix Scooters OWNER'S MANUAL



Model years 2004 through 2008

Dear Customer,

Thank you for choosing the ETON Beamer.

This scooter was made in accordance with the international QS9000 standards and the directives of the European parliament and council. It conforms to all Federal DOT regulations for a class A moped.

It was engineered and designed to provide a reliable form of economic transportation for your life style. This manual was designed to provide you with the basic understanding of the structure, function, operation and maintenance of the Beamer Scooter. By following the instructions in this manual, you will be able to maintain the performance and prolong the service life of your Beamer Scooter.

We at ETON wish you many years of pleasurable driving.

ETON America, LLC.

Important Notices

READ and UNDERSTAND this owner's manual

The operator should completely read and understand this owner's manual before operating this vehicle. This owner's manual will instruct you in the safe operation of the vehicle. This manual contains warnings and cautions for some specific service methods which could cause personal injury and/or damage to the vehicle.

ALWAYS Wear Protective Clothing

While operating this vehicle, the driver must always wear protective clothing. Protective helmet with face shield, and hard soled boots should always be worn when operating this vehicle.

OBEY all State and local laws and regulations

Each state and local governing agency has laws and regulations for scooter operations. It is the owner's responsibility to know, understand and obey these laws and regulations.

SPEED RESTRICTION Devices

This vehicle is equipped with electronic speed limiting devices. Any attempt to change, over-ride or bypass these devices may cause dangerous operating conditions.

Due to continuing upgrades to our product line, information in this manual is subject to change without notice. Please contact your local dealer for further information regarding current information about your Beamer scooter.

Table of Contents

Vehicle identification number location	3
Controls, switches and feature locations	3
Control feature operations	
Engine stop switch	4
Turn Signal Switch	4
Horn Button	4
Engine Manual Choke Lever	4
Head Light Control Switch	4
Ignition Switch	5
Instrument Cluster	5
Throttle Control	6
Throttle Cable Adjustment	6
Brake Systems	
Front and Rear brakes	6
Front Hydraulic Brake Inspection	7
Hydraulic Fluid Reservoir	7
Purging the brake lines	8
Rear Brake Inspection	8
Fuel System	9
Fuel tank	9
Fuel Cap	9
Inline Fuel Filter	9
Engine Oil	10
Oil Indicator light	10
Oil Tank	10
Transmission Oil Change	11
Tires and Wheels	11
Tire pressure	11
Spark Plug	11
Spark Arrester Screen	11
Air Filter	11
Electrical Battery	13
C.V.T. Air Filter (Transmission)	13
Front Forks	13
Beamer Break-In Procedure	14
Pre-Operation Inspection	14
Starting procedure	14
Driving	14
Parking	15
Specifications	16
Maintenance Schedule	17
Wiring Diagrams	18-19
Reporting Safety Defects	20
Manufacturer's Warranty	21
Owner's notes	23

Vehicle Identification Numbers



Vehicle Identification Number (VIN) is located on the frame behind the foot guard and is covered by a small plastic cover plate which can be removed with a screwdriver.



Engine serial number is located on the left-hand side of the engine on the crankcase housing.

Controls, Switches & Feature Locations

Locations of controls and features

1. Front Brake lever

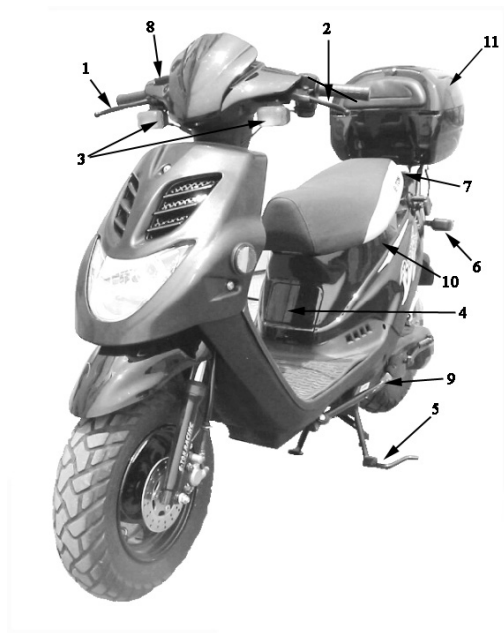

2. Rear Brake Lever
 3. Front Turn Indicator Lamps
 4. Oil Tank
 5. Main Parking Stand
 6. Rear Turn Indicator Lamps
 7. Fuel tank Cap
 8. Brake Fluid Reservoir
 9. Side Kick Stand
 10. Under Seat Helmet Box
 11. Luggage Box*
- * (Standard on Matrix, Optional on Beamer II)



Control feature operations



Engine Stop Switch

The stop switch is a red colored rocker switch located on the left-hand handlebar.

To start and run the engine, this switch must be placed in the on, "O" position.

The vehicle is also equipped with a safety brake switch which will prevent the engine from starting until the parking brake is engaged.

To stop your engine, place the switch to the stop, "X" position.

In the stop, "X" position the ignition system is grounded preventing the spark plug from firing.

This switch can also be used as a safety or emergency stop switch.

Turn Signal Switch

The turning signal switch is a three position switch located on the left-hand handlebar. Sliding the switch in the direction of the intended turn will illuminate the front and rear turn signal lamps in a blinking mode. Pressing the white button, on the center of the switch, will return the switch to the neutral position and cancel the illumination of the turning lamps.

Horn Button

The horn button is a yellow push switch, located below the turning signal lamp switch on the left-hand handlebar. Pressing in on the button will

sound the audible horn signal. Releasing the button will silence the horn.

Engine Manual Choke Lever

The engine choke lever is used to enrich the fuel mixture when starting the engine from a cold start. Start by moving the lever to the left to choke the engine. After allowing the engine to warm up for 15-20 seconds, slowly move the lever back to the right until the engine idles down runs smooth. The lever to the full right is the normal operation position.



Right Handlebar Control

Head Light Control Switch

For safety, the head light system of this unit was designed to be illuminated at all times while the unit is running. The intensity of the light is changed by using the head light control switch located on the right-hand handlebar. It is a three position slide switch. Far right position sets beam intensity to 20% (Day Time Running), middle position sets beam intensity to 80% (Low Beam), and far left position sets beam intensity to 100% (High Beam).

The vehicle is equipped with a PTC controller that will dim the lights to the 20% position automatically if the engine RPM falls below the pre-set threshold for more than a minute. Increasing the engine RPM will return the light to the normal level for the control switch selection.



Ignition Switch

The ignition switch is located on the control column's right side below the handlebars. A key is required to work the switch. This switch has three positions, "O" On, "X" Off and "🔒" Locked. The switch must be in the "O" on position for the engine to start and run. The "X" off position disconnects power to the ignition and light circuits and stops the engine. The "🔒" locked position, locks the steering column and allows the key to be removed. In order to turn the key to the "🔒" locked position you must press down on the key with the steering column turned slightly to the left.

NOTE: Always lock your vehicle when leaving it unattended and take your keys for additional security against theft of your vehicle.

The ignition key also unlocks your fuel cap and under seat storage compartments.



Instrument Cluster

The instrument cluster provides you with operating conditions of your vehicle. To the left is the fuel gauge which indicates the fuel level in the fuel tank. When the needle reaches the red zone on the gauge, you are running low on fuel and the tank should be refilled. This gauge is controlled by a fuel level sending unit located inside the fuel tank.

The center speedometer indicates the current speed of your vehicle. The speedometer is calibrated in both MPH, (Miles per hour) and KPH, (Kilometers per hour). This gauge is controlled by a cable attached to the front wheel of the vehicle.

The right side is a series of three indicator lamps. The top most lamps in the cluster will indicate that the turn signals have been activated and also indicates which signal lamps are illuminated.

The right indicator lamp indicates the head light controller is in the Hi-Beam, 100%, position when illuminated.

The left lamp indicates the 2 cycle oil level in the oil tank. When illuminated your oil tank is low and needs to be refilled. Continued operation of the engine with a low oil condition will cause severe damage to the engine and potentially unsafe operating condition. Refill your oil tank with High grade JASO FC 2 cycle injector oil.



Throttle Control

The throttle control is the right-hand handle grip. Throttle is controlled by twisting the grip. The throttle control is spring loaded and set at the factory to return to the idle position when pressure is released.

To increase the throttle, twist the handle grip in a counter clockwise rotation. To decrease throttle, twist the hand grip in a clockwise rotation or release your pressure and allow the throttle to return on it own.

The throttle cable should be adjusted so there is 5-10mm, ($\frac{1}{4}$ ") free travel of the throttle hand grip before the throttle starts to open.

Keep the throttle cable lubricated and operating smoothly. If the cable sticks or is hard to operate, lubricate the cable by disconnecting the cable from the throttle hand grip and lubricating with a commercial cable lubricant available at your dealer.

Replace the cable if it shows signs of fraying or corrosion or is kinked or bent.



Throttle Cable Adjusting

To adjust the throttle cable's free play, slide the protective cover down the cable to expose the cable adjusting system. Loosen the locking nut and adjust the cable length by turning the adjusting collar. Check the free travel in the throttle hand grip until you have 5-10mm, ($\frac{1}{4}$ ") free travel. Tighten the locking nut against the adjusting collar and slide the protective cover over the adjusting system. Replace the cable if there is no adjustment remaining or the proper free travel cannot be obtained with the adjustment system.

Front and Rear Brakes

This vehicle is equipped with front mechanical hydraulic disc brake and a rear mechanical drum brake.

The front brake is controlled by the long brake lever on the right-handlebar.

The rear brake is controlled by the long lever on the left-Handlebar.

The rear brake is the primary stopping brake on your vehicle. Using the rear brake to stop your vehicle will prevent steering control loss.

Use your front and rear brakes in combination to control your speed while descending a grade. Use caution not to apply too much pressure to your front brake so that the wheels lock up, stop turning, and cause a loss of steering control. If the front wheels lock up, stop turning, lightly reduce the pressure on the front brake lever until it unlocks and the wheel start to turn.



The fluid level should fill at least $\frac{3}{4}$ of site glass when the unit is setting on a level surface.

Test the brakes by applying pressure to the brake lever and trying to push the unit forward. If the wheel rotates while the brakes are applied, check your fluid level and brake pads. If the brake lever feels spongy or does not stop when squeezed, you may have air in the lines. All air must be purged from the brake lines for the disc brake to operate properly. (See purging brake lines).

Front Brake System Inspection

Visually inspect the brake lines for any signs of wear. Inspect the lines for leaks at all connections and look for wear along the entire line. Replace the line if any worn areas are found. The brake line is under great pressure when the brakes are applied and any worn spot could cause a rupture of the line.

Inspect the brake arm, spring, rod and fastener for signs of wear or damage. Operate the brake lever while watching the brake mechanism for proper operation. Tighten, repair or replace parts as needed to insure safe brake operation. Clean any build-up of mud or debris from the brake mechanism.

The brakes are equipped with a wear indicator to alert you when your brake pads need replacing. Apply light pressure to the brake lever and slowly push the unit forward. If you hear a high pitched metallic scraping sound, you need to replace your brake pads. The minimum pad thickness is 3.0mm.

DO NOT RIDE A VEHICLE WITH WORN BRAKE PADS.

Check the rotor disc for cracks, warping or color distortion. Replace rotor disc at first sign of problem.

Check rotor disc thickness. Minimum thickness is 3.1mm. Replace the disc if below minimum thickness.

Check the fluid level in the fluid reservoir by checking the site glass for the level.



To Fill the Reservoir

Remove the reservoir cover by removing the two cover bolts.

Fill the reservoir to 1/8" from top with Dot-3 SAE-J1703 grade brake fluid.

Caution: DO NOT allow dirt to fall into the reservoir.

Refold the cover gasket as shown in picture and replace cover and bolts.



Purging Brake Lines

For the hydraulic brake system to operate safely, the brake system must be purged of air in the lines and reservoir.

To bleed the air will require two people to perform the following procedure.

1. Place a drain pan under the brake caliper to catch the fluid.
2. Open the bleeder valve ½ turn counter clockwise.
3. Squeeze the brake lever to expel air from the system.
4. While holding the brake lever, close the bleeder valve.
5. Repeat steps 2 through 4 until the brake fluid coming from the bleeder valve is a solid stream without any air, then close the valve and replace rubber protection cap.
6. Test the brake system by squeezing the lever. The lever should feel firm and stop without fading.

Rear Brake System Inspection



Check the brakes for smooth operation. The brake cable should move freely and apply the brakes with minimal effort. If the cable sticks, hangs up, or requires a larger amount of effort to apply the brakes the cable may be damaged or need lubricating.

Visually inspect the brake cable for any signs of wear, fraying, kinking or corrosion. Replace any worn, frayed, corroded or kinked cable. Lubricate

the brake cable with a commercial cable lubricant available through your dealer.

Test the rear brake by applying pressure to the brake lever. Try pushing the vehicle with the brakes applied. If the rear wheel turns the brakes may need to be adjusted or replaced.



To adjust the rear brake, turn the adjusting nut located on the brake arm on the rear wheel. Adjust the nut so that the brake arm engages whenever the rear brake lever is squeezed. CAUTION: do not over tighten the nut to the point that the brake shoes are in constant contact with the brake drum.

Replace the brake cable and/or shoes when there is insufficient adjustment left to apply the brake completely.

Rear brake drum tolerances are:

Inner diameter of drum

Standard: 110mm / 4.330696"

Minimum: 110.5mm / 4.350381"

Brake Shoe Lining

Standard: 4.0mm / 0.1574798"

Minimum: 2.0mm / 0.07873992"

Fuel System



Fuel Tank & Locking Cap

The fuel tank fill cap is located at the rear of the vehicle just behind the seat. Your vehicle is equipped with a locking fuel tank cap that is opened with the same key that is used in the ignition switch.

To unlock your cap simply insert the ignition key into the lock and turn clockwise until the cap releases. Lift the cap from the tank and refuel your vehicle with unleaded automotive grade gasoline of 89 octane or higher.

To replace the cap, align the locator lug on the cap with the notch in the tank neck and press the cap down until you hear the locking lugs click.

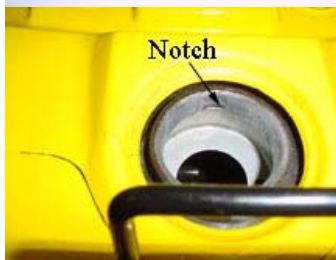
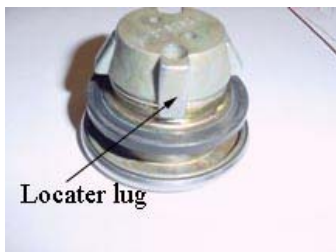

Every time you refuel your unit, check the rubber seal inside the cap for cuts, tears and dirt. Clean

or replace the seal if it becomes worn or torn. The seal must be in good condition to insure a proper seal of the cap to the tank to prevent fuel spills. **DO NOT** allow dirt or other debris to enter the tank when refueling.

Replace the cap if damaged or if it will not seal to the tank.

The fuel tank capacity is 5.5 liters, 1.5 gal.

NEVER REFUEL YOUR VEHICLE when

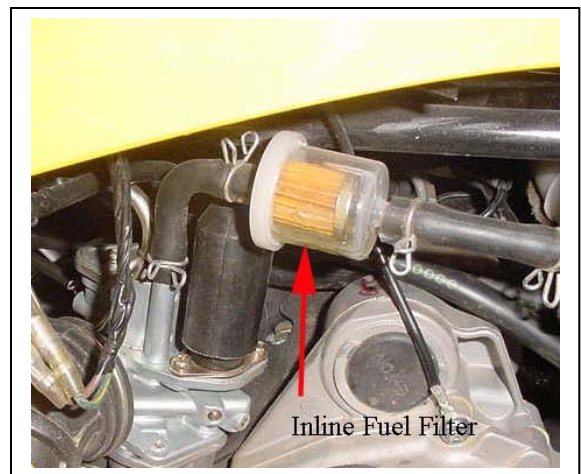

the engine is running or with a hot exhaust system. Wait 30 minutes after turning off the unit before refueling. Spilling fuel on a HOT engine or exhaust could cause a fire. Wipe up any fuel spills before re-starting.

Inline Fuel Filter

Your vehicle is equipped with an inline fuel filter to prevent dirt and debris from entering the carburetor and engine.

The filter should be replaced every 10,000 miles or each year of operation.

Replacement and fuel line inspection should be performed by an authorized ETON dealer only.

DO NOT start or operate the engine if the fuel filter or lines are leaking. Leaking fuel can cause a fire.

Engine Oil

Your vehicle uses 2 cycle oil to lubricate the engine. The oil tank is located under the seat at the front of the unit. Oil is drawn from this tank by an oil injector pump when the engine is operating.

Oil Level Warning Light



The unit is also equipped with an oil level indicator lamp. The lamp will light when the oil level in the tank is low. When the lamp is lit you MUST refill the oil tank.

DO NOT allow the engine to operate with an empty oil tank. Doing so will result in extensive damage to your engine. This damage is not covered under the warranty.

Check the oil tank level manually every 500 miles of operation.



The oil tank is located under the seat in the front of the vehicle. It is accessed by removing the Oil



tank cover retaining screw and lifting the cover. The oil tank capacity is 1.1 liters, 1.2qt.

Fill the tank with high quality JASO FC grade 2 cycle injector engine oil. Using lower grade oil can cause exhaust smoke and result in damage to your engine.

IMPORTANT NOTE:

Your first tank of fuel should be a pre-mix fuel with a 50:1 fuel to oil ratio. This will insure the engine is lubricated and give the oil pump time to bleed any air from the oil line that may have occurred during shipping.

If your unit is creating excessive smoke from the exhaust insure that you have used a JASO FC grade 2 cycle injector oil in the tank. If you are sure your oil is of the correct grade, your oil pump may need adjustment. The oil pump must be adjusted by an authorized ETON Dealer.

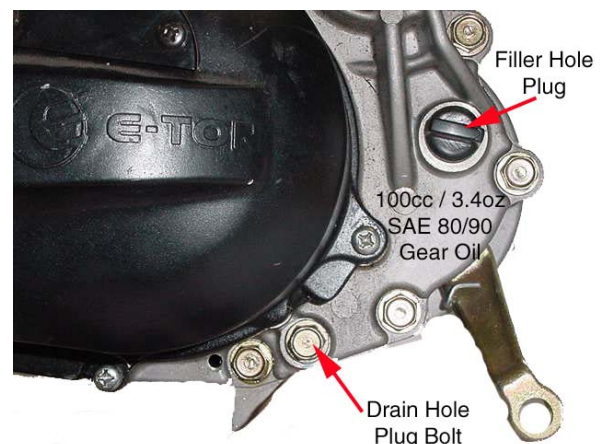

Changing Transmission Oil

1. Place an oil catch pan under the unit directly below the transmission box.
2. Remove the transmission box drain plug located on the bottom of the transmission box on the (LH) side of the engine.
3. Remove the transmission box fill hole plug located on top of the transmission box on the (LH) hand side of the engine
4. Allow the oil to drain completely (15-30 min).
5. Reinstall the drain plug and tighten. Torque to 7-10lbf-ft
6. Fill the transmission box with of SAE 80-90 gear oil (100cc / 3.4oz)
7. Reinstall the fill hole plug. Torque to 2-3lbf-ft.
8. Dispose of used oil at a proper recycling station as required by law.

Tires and Wheels

The tires and wheels of your Beamer have been engineered to match the suspension to give you a smooth, comfortable ride. They were also designed to afford you with mileage economy, to give you the best miles per gallon possible.

Tire Size & Pressure

Recommended tire pressure (Cold) is:
Front 120/90-10 18psi / 1.25kg/cm²
Rear 130/90-10 25psi / 1.75kg/cm²

Spark Plug

Replace the spark plug every 10,000 miles or if the plug should become damaged or fouled. We recommend that you use NGK - BPR7HS.

Disconnect spark plug wire.
Clean dirt from around spark plug base with brush or air. (Caution: do not allow dirt or foreign material to enter the engine)

Remove spark plug with spark plug wrench.
Set the spark plug gap on the new plug to 0.023".

Install the new plug screwing it in finger tight and then use the plug wrench to screw the plug in another ½ turn.
Inspect the spark plug wire for cuts, nicks or other damage. Replace as needed.

Air Filter



Air Filter Maintenance

To maintain the highest performance from your engine and to reduce excessive wear that could cause engine failure the engine requires a continuous flow of clean air. Air is taken into the engine through an air filter to clean the air prior to mixing it with fuel and oil in the carburetor.

During normal operation the filter accumulates dirt from the air and will need to be cleaned to maintain the proper air flow. The filter should be cleaned every 3000 miles, more often if you ride in a dusty or dirty environment and the element should be replaced every year.

The air filter box is located on the left side of the engine under the body cover. It is a black box about 6" square and is attached to the crankcase with two bolts and the carburetor by a tube.

To clean the filter

Remove the air filter box cover.

Remove the filter element from the air box.

Wash the element in a non-flammable solvent such as Air-Filter cleaner from your local auto parts dealer.

1. Dry the element completely before continuing.
2. Soak the element in clean engine oil until completely saturated.
3. Squeeze out the excess oil until the element



does not drip any oil.

4. Allow the element to dry then reinstall the element and cover.

Electrical Battery



The unit's battery is located under the floor board mat and supplies electrical power to the unit. The battery is a 12 volt gel acid type that contains no liquid electrolyte. The battery should be removed from the vehicle when stored for extended periods and charged before being replaced in the unit. Use a trickle charger set at 12 volts to recharge the battery to full charge before replacing it in the unit.

When reinstalling the battery, be sure to connect the red cable to the positive (+) terminal and the black cable to the negative (-) terminal.

The battery should be replaced every three years or when it no longer holds a charge.

Do not expose the battery, for extended periods of time, to freezing temperatures. If the battery has been frozen it will need to be replaced.

There is an inline fuse on the positive lead of the battery to protect the wiring system from over loads. If your starter motor will not turn over and the battery is fully charged, check the inline fuse on the unit.

Replace the fuse with a 7A fuse.

C.V.T. Filter

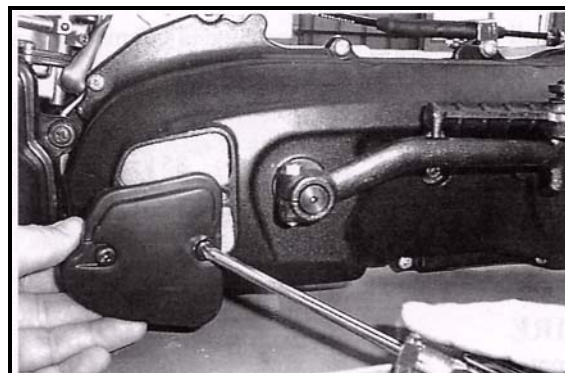

This unit is equipped with an air filter for the C.V.T. transmission. It is located on the left-hand side of the engine, just ahead of the kick starter spindle. The filter will accumulate dust and must be cleaned periodically to maintain normal vehicle operations. Inspect and clean the filter every 3000 miles, more frequently if operated in a dusty environment.

To clean the filter, remove the two cover bolts and remove the filter. Clean the filter element in a non-flammable solvent and let dry completely before reinstalling. Replace the filter element and the cover.

FRONT FORKS

Check the front forks of your vehicle for signs of damage or leaking oil. If either is noticed, return the vehicle to your dealer for service.

Beamer Break-In procedures

Your Beamer requires a break-In period just as with all other internal combustion engines. This period allows the engine parts to seat and wear properly without undue strain which can cause premature failure.

1. For the first 1000 miles of operation do not operate your vehicle above 18mph. for extended periods of time.
2. Your first tank of fuel should be a pre-mixture of fuel and oil at a 50:1 ratio. This will insure that the oil pump system has been primed and bled of air that may have occurred in shipping.
3. Do not over rev the engine.
4. Use light braking pressure to allow the brake pads to seat to the rotor and drums.

Pre-Operation Inspection procedure

The following procedure must be performed before each operating session.

Checking your Scooter takes only a few minutes and may save you from serious injuries and costly repairs.

1. Check engine oil level.
2. Check engine fuel level.
3. Check brake operations and brake fluid level.
4. Check tire condition and pressure.
5. Check throttle operation and free play adjustment.
6. Check engine stop switch for proper operation.
7. Check steering system. Look for free and smooth operation. Check all fastening hardware.
8. Check all nuts, bolts and other fasteners for loose conditions.
9. Inspect unit for any broken or damaged parts.
10. Check all indicator lights and switches for proper operation.

11. Insure you are wearing proper clothing and protective gear, such as helmet and hard soled shoes.

Starting Procedure

The following procedure must be followed each time you start your Beamer.

Park the unit on a level surface. Insert the key into the ignition switch and turn to the "ON" position.

Turn the engine stop switch to the "ON" position.

Apply slight pressure to the throttle grip. Hold in both brake levers while pressing the starter button on the right handlebar switch.

NOTE: Your Beamer is equipped with a safety brake interlock switch which will prevent the engine from starting without the brakes being applied.

Your unit should start within 10 seconds of pushing the starter button. If the unit fails to start check the following:

1. Engine stop switch is "ON".
2. Brake levers applied

If your battery does not have enough charge to turn the starter motor you can use the alternate kick starter to crank the engine. Swing the kick starter foot peddle to the out board position and while holding both brake levers, apply a quick downward push to turn the engine over.

Driving your Beamer

Your Beamer was manufactured to meet all Federal D.O.T. regulations. State and local regulations govern the use of this class of vehicle. Check with your local DMV office before riding this vehicle on the highway.

Set yourself in a comfortable position on the seat with both hands on the handlebars. Ensure that you have an unobstructed operating area from which to control your

Beamer. When carrying a passenger, always insure that they place their feet on the passenger pedals. Always keep your feet on the footrests and your hands on the handlebar grips while operating your Beamer. Doing so will give you the best control of the unit.

Be sure that you and your passenger are NOT wearing loose fitting clothing that could become entangled in the moving parts of the vehicle.

Start the vehicle in a forward motion by slowly increasing the throttle pressure.

Never place more than 12lbs / 5kg load on the rear rack. Doing so may cause the vehicle to become unbalanced and cause an unsafe driving condition.

Never carry anything on the handlebars or your lap while driving your vehicle. Doing so can cause a loss of control over the vehicle.

Learn to steer your scooter by shifting your weight in the direction of the turn. (Lean into the turn)

Use your front & rear brakes to control your speed and to stop. Sudden braking force can cause the vehicle to start sliding. To regain control, release the braking pressure until you have regained control of the vehicle.

When the road surface is wet, the braking distance is double that of when the road surface is dry.

Keep a safe distance between yourself and the vehicle in front of you.

It is not recommended to operate this vehicle in slippery conditions such as on snow or ice covered roads.

When going downhill, release the throttle grip and use your brakes to control your speed.

After washing your vehicle your brake shoe and pad may have become wet and will reduce the braking force until they have had a chance to dry.



Parking Your Scooter

1. Always park your vehicle on a level surface.
2. Turn the ignition key to the "OFF" position to stop the engine.
3. Set the engine stop switch to "OFF" position.
4. Turn your front wheel slightly to the left and turn the ignition key to the lock position to lock the steering column.
5. Remove the ignition key to prevent unauthorized use or theft of your vehicle.
6. Park the vehicle by using either the main parking stand or the side kick stand. The stands are located on the left-hand side of the vehicle.

Beamer Scooter Specifications

		Beamer II & Matrix (Models - PN2B & PN2C)
Engine		
Type	Two cycle air cooled oil injected	
Displacement	49.3cc	
Bore / Stroke	φ40.0 * 39.2mm	
Compression	6.8 : 1	
Power	5.2hp @ 7000rpm	
Transmission		
Type	Automatic (C.V.T. V-Belt)	
Chassis		
Overall Length	1830mm / 72.0"	
Overall Width	650mm / 25.6"	
Overall High	1100mm / 43.3"	
Wheel Base	770mm / 30.3"	
Dry Weight	82kg / 180.7lb	
Suspension		
Front	Telescopic Fork	
Rear	Unit Swing Arm / Single Shock	
Brakes		
Front	Hydraulic Disc	
Rear	Mechanical Drum	
Tires		
Front	120/90-10	
Rear	130/90-10	
Tire Pressure	Front 18psi / 1.25kg/cm2 (Cold) Rear 25psi / 1.75kg/cm2 (Cold)	
Carburetor		
Make/Size	Mikuni 18mm (Electrical Choke)	
Main Jet	85mm	
Pilot Jet	20mm	
Air Mixture Adjustment	Back out ¾ - 1¼ turns Idle 1700 - 1900rpm	
Battery		
12V-4AH/5AH - GTX5L-BS		
Fluids		
Fuel	Type	Unleaded Gasoline 89 octane
	Volume	5.5liters / 1.5gal
2 Cycle Oil	Type	High grade synthetic 2 cycle injector oil
	Volume	1.1 liters / 1.2qts
Transmission	Type	SAE 80/90 weight
	Volume	100cc / 3.4oz

Spark Plug	
NGK (recommended)	BPR7HS
Nipendenso	W22FRP-U
Champion	QL82YC
Electrode Gap	0.6-0.7mm / 0.023"
Max Driver & Passenger Weight	150kg / 330lbs.
Subject to change without notice	10/01/203

Maintenance Schedule

	INITIAL SERVICE (First week)	REGULAR SERVICE (Every 30 operating days)	EVERY YEAR
Fuel Line			I
Throttle Operation	I	I	I
Air Filter system & Element	I	C	R
Spark Plug		I	R
Carburetor Idle Speed	I	I	I
Brake Shoe Wear	I	I	I
Brake System	I	I	I
Nut, Bolt, Fastener	I	I	I
Wheels & Wheel Nuts	I	I	I
Steering System		I	I
Suspension System		I	I
C.V.T. Air Filter		C	R
Air Induction Reed Valve		I	C/R
Transmission Gear Oil		I	R

Note –

I: Inspect and Clean, Adjust, Lubricate, or Replace (if necessary)

C: Clean

L: Lubricate

R: Replace

NOTE: E-TON recommends that all maintenance and inspections be performed ONLY by a qualified and fully trained technician!

2004-2006 Beamer, Beamer II & Matrix Wiring Diagram

Ref#	Color	Ref#	Color
1	Black	12	Red/White
2	Red	13	Brown/White
3	Red	14	Orange
4	Brown	15	Blue/White
5	Gray	16	White/Blue
6	Yellow	17	White/Red
7	Green	18	Green/Yellow
8	Dark Green	19	White
9	Pink	20	Yellow/Red
10	Light Brown	21	Blue/Yellow
11	Green/White	22	Blue/Yellow

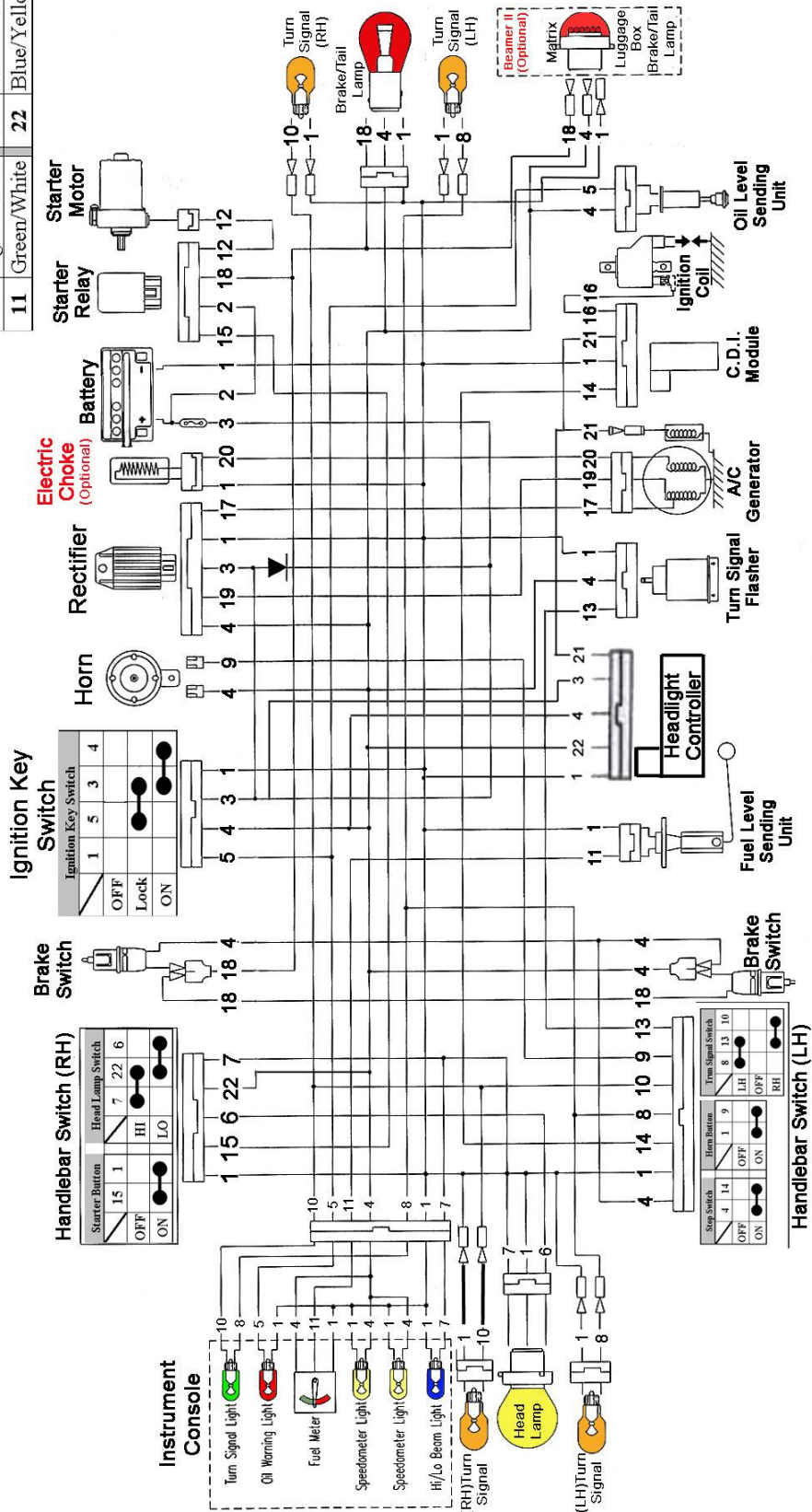

05/19/04

2007-2008 Beamer III & Matrix II Wiring Diagram

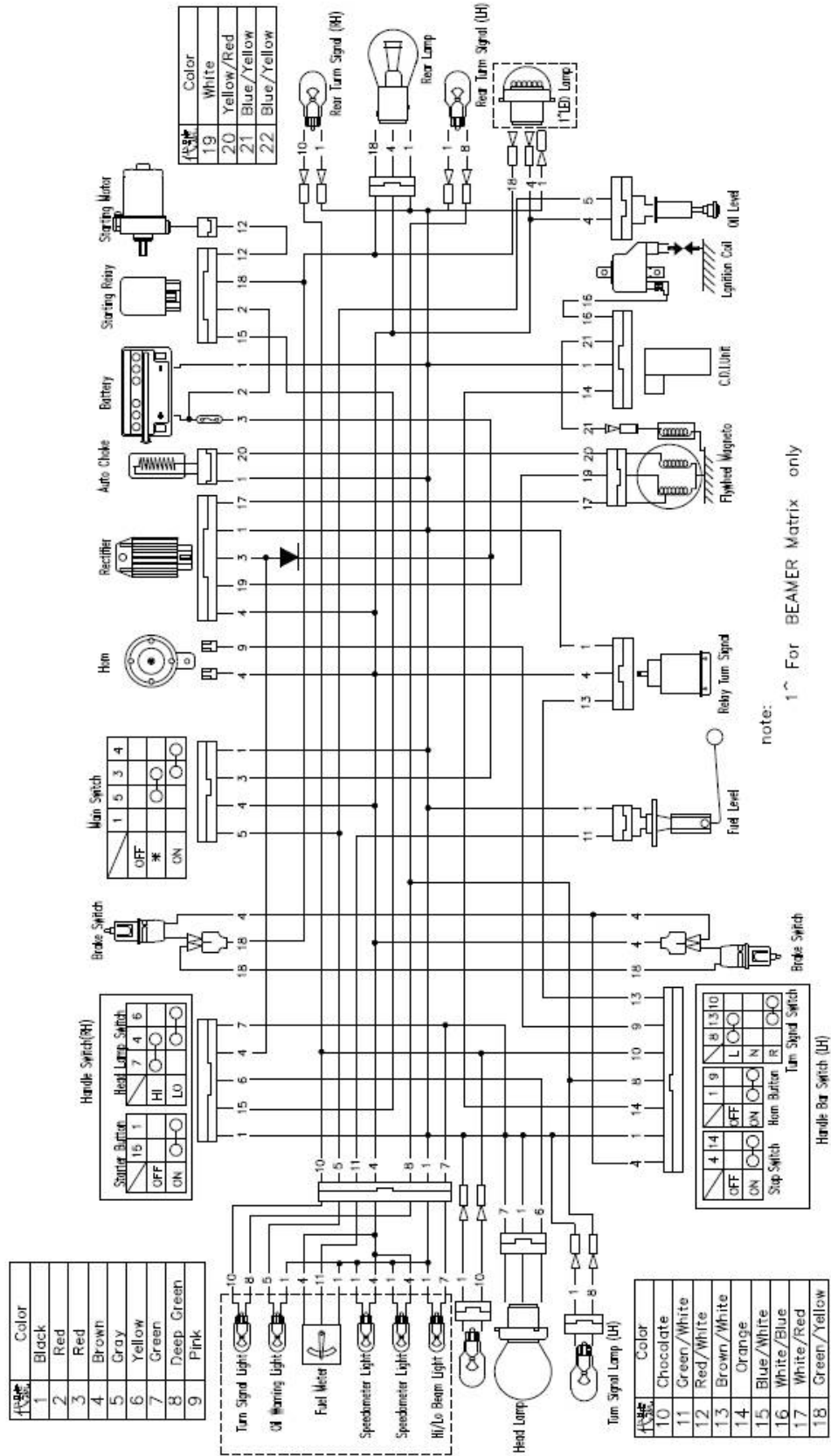

NHTSA Safety Notice

If you believe that your vehicle has a defect which could cause a crash or could cause injury or death, you should immediately inform the National Highway Traffic Safety Administration (NHTSA) in addition to notifying ETON America, LLC.

If NHTSA receives similar complaints, it may open an investigation, and if it finds that a safety defect exists in a group of vehicles, it may order a recall and remedy campaign. However, NHTSA cannot become involved in individual problems between you, your dealer, or ETON America, LLC..

To contact NHTSA, you may call the Vehicle Safety Hotline toll-free at 1-888-327-4236 (TTY: 1-800-424-9153);

or go to <http://www.safercar.gov>

or write to:
Administrator,
NHTSA
400 Seventh Street, SW.
Washington, DC 20590.

You can also obtain other information about motor vehicle safety from <http://www.safercar.gov>



ETON AMERICA, LLC.

LIMITED VEHICLE WARRANTY

ETON America warrants all new ETON vehicles sold by authorized Eton Dealers to be free from defects in materials and workmanship, subject to the following exclusions and limitations. New vehicles sold by an authorized dealer to original retail consumers are covered by this policy for a period of six (6) months from the date of delivery. There is no mileage limitation.

Vehicles used in rental service or for certain commercial purposes are specifically excluded from this policy. (Check with your dealer for warranty application.)

Items and conditions that are specifically excluded from this warranty program are:

1. Damage caused by accidents, misuse, negligence, improper vehicle operation.
2. Any modification or alteration to any standard specifications or equipment.
3. Any repairs made by an unauthorized dealer or service firm.
4. Use of non-ETON genuine parts for repairs or alteration to standard specifications.
5. Damage caused by failure to perform factory scheduled service maintenance.
6. Damage which occurs as a result of improper storage.
7. Damage caused by the use of improper fuel or lubricants, and/or failure to use proper oil/gas mixture on two stroke models.

The following normal wear parts are specifically excluded from warranty coverage:

1. Rubber parts
2. Tires
3. Belts
4. Brake linings
5. Normal wear item
6. Brake parts
7. Cables
8. Filters
9. Spark plugs
10. Bulbs
11. Batteries
12. Sprockets
13. External springs
14. Seat and hand grips.



ETON AMERICA, LLC.

LIMITED VEHICLE WARRANTY

Scheduled maintenance service is the responsibility of the owner during and after the warranty period. In the event of a failure or required repair, the owner should take the vehicle to an authorized dealer for repair without undue delay and within a maximum of thirty (30) days of the occurrence of the problem. All eligible warranty repairs must be made at any authorized dealer's normal place of business. Any transportation costs, or other expenses which may occur in order to obtain warranty service, are the responsibility of the owner. All eligible repairs covered under this warranty will be paid to the servicing dealer only, by ETON America, and no additional payments shall be made for authorized warranty repairs.

Dealer and/or ETON America are not responsible for loss of use, other damage or inconvenience due to warranty repairs. It is the customer's/buyer's responsibility to review with the selling dealer the pre-delivery service schedule to assure that the machine is properly serviced prior to delivery acceptance. It is recommended that the buyer take a test ride to familiarize themselves with the machine and to make certain the unit is in proper operating condition. The dealer is responsible for checking and performing all items on the "set-up and pre-delivery checklist" prior to delivery to the customer.

This warranty is valid at any authorized ETON Dealer in the United States only. In the event you experience any problem obtaining prompt service, contact ETON America's customer service department for assistance. Always consult first with your selling dealer and/or service personnel for assistance with any service work or repairs. In the event you have a problem obtaining service send your name, address, and vehicle identification number to Eton America for assistance.

The above stated policy is the only policy offered and backed by ETON America, and no other organization or individual is authorized to make or offer any different arrangements. Some states prohibit certain limitations or conditions or do not allow exclusions or limitations. You may be eligible for additional consideration, so check with your local dealer or appropriate state agency for assistance. Rights vary from state to state, and you may have other rights not offered in this warranty.

ETON America warrants that all new vehicles comply with applicable US regulations.



ETON AMERICA, LLC.

LIMITED VEHICLE WARRANTY

ETON America warrants all new ETON vehicles sold by authorized ETON Dealers to be free from defects in materials and workmanship, subject to the following exclusions and limitations. New vehicles sold by an authorized dealer to original retail consumers are covered by this policy for a period of six (6) months from the date of delivery. There is no mileage limitation. This warranty is given to the original retail purchaser and is non-transferrable.

Vehicles used in rental service or for certain commercial purposes are specifically excluded from this policy. (Check with your dealer for warranty application.)

Items and conditions that are specifically excluded from this warranty program are;

8. Damage caused by accidents, misuse, negligence, improper vehicle operation,
9. Any modification or alteration to any standard specifications or equipment.
10. Any repairs made by an unauthorized dealer or service firm,
11. Use of non-ETON genuine parts for repairs or alteration to standard specifications.
12. Damage caused by failure to perform factory scheduled service-maintenance.
13. Damage which occurs as a result of improper storage.
14. Damage caused by the use of improper fuel or lubricants, and/or failure to use proper oil/gas mixture on two stroke models.

The following normal wear parts are specifically excluded from warranty coverage:

15. Rubber parts
16. Tires
17. Belts
18. Brake linings (after 30 days)
19. Normal wear item
20. Brake parts
21. Cables
22. Filters
23. Spark plugs
24. Bulbs
25. Batteries (after 30 days)
26. Sprockets
27. External springs
28. Seat and hand grips.

Scheduled maintenance service is the responsibility of the owner during and after the warranty period. In the event of a failure or required repair, the owner should take vehicle to an authorized dealer for repair without undue delay and within a maximum of thirty, (30), days of the occurrence of the problem. All eligible warranty repairs must be made at any authorized dealer's normal place of business. Any transportation costs, or other expenses which may occur in order to obtain warranty service, are the responsibility of the owner. All eligible repairs covered under this warranty will be paid to the servicing dealer only, by ETON America, and no additional payments shall be made for authorized warranty repairs.

Dealer and/or ETON America are not responsible for loss of use, other damage or inconvenience due to warranty repairs. It is the customer/buyer's responsibility to review with the selling dealer the pre-delivery service schedule to assure machine is properly serviced prior to delivery acceptance. It is recommended that the buyer take a test ride to familiarize themselves with the machine and to make certain the unit is in proper operating condition. The dealer is responsible for checking and performing all items on the "set-up and pre-delivery checklist" prior to delivery to the customer.

This warranty is valid at any authorized ETON Dealer in the United States only. In the event you experience any problem obtaining prompt service, contact ETON America, customer service department for assistance. Always consult first with your selling dealer and or service personnel for assistance with any service work or repairs. In the event you have a problem obtaining service send your name, address, and vehicle identification number to Eton America for assistance.

The above stated policy is the only policy offered and backed by ETON America, and no other organization or individual is authorized to make or offer any different arrangements. Some states prohibit certain limitations or conditions or do not allow exclusions or limitations. You may be eligible for additional consideration, so check with your local dealer or appropriate state agency for assistance. Rights vary from state to state, and you may have other rights not offered in this warranty.

ETON America warrants all new vehicles comply with applicable US regulations.



ETON AMERICA, LLC.

LIMITED VEHICLE WARRANTY

LIMITATIONS. This Limited Vehicle Warranty shall not cover any of the following:

Repairs or replacement required as a result of (i) accident, (ii) misuse or neglect, (iii) lack of reasonable and proper maintenance, (iv) repairs improperly performed or replacement improperly installed, (v) use of replacement parts or accessories not conforming to ETON America LLC specifications which adversely affect

- 1) performance and/or durability, (vi) alterations or modifications not recommended or approved in writing by ETON America LLC, and/or (vii) use in competitive racing or related events.
- 2) Replacement of parts and other services and adjustments required for routine maintenance.
- 3) Any vehicle on which odometer mileage has been changed so that the actual mileage cannot be determined.

LIMITED LIABILITY.

The liability of ETON America LLC under this Limited Vehicle Warranty is limited solely to the remedying of the defects in the materials or workmanship by any authorized ETON America LLC vehicle dealer at its place of business during customary business hours. Please refer to ETON America LLC website: www.etonamerica.com. This warranty does not cover inconvenience or loss of use of the Scooter/moped vehicle, or transportation of the Scooter/moped vehicle to or from the ETON America LLC authorized dealer. ETON America LLC SHALL NOT BE LIABLE FOR ANY OTHER EXPENSE, LOSS OR DAMAGE, WHETHER DIRECT, INCIDENTAL, CONSEQUENTIAL OR EXEMPLARY ARISING IN CONNECTION WITH THE SALE OR USE OF OR INABILITY TO USE THE ETON America LLC SCOOTER/MOPED VEHICLE FOR ANY PURPOSE, SOME STATES DO NOT ALLOW THE EXCLUSION OR LIMITATION OF ANY INCIDENTAL OR CONSEQUENTIAL DAMAGES, SO THE ABOVE LIMITATION OR EXCLUSION MAY NOT APPLY TO YOU.

ETON America LLC

SCOOTER/MOPED LIMITED WARRANTY FEDERAL EMISSION CONTROL SYSTEMS

ETON America LLC warrants each new scooter/moped vehicle that includes as standard equipment a taillight and a stoplight;

- a) Is designed, built and equipped so as to conform at the time of initial retail purchase with all applicable regulation of the United States Environmental Protection Agency ("US EPA") and;
- b) Is free from defects in material and workmanship which would cause such Scooter/moped vehicle to fail to conform with applicable regulations of the US EPA, for a time period of two and a half (2.5) years and, depending on the engine displacement:

This warranty period shall begin on the date the Scooter/moped vehicle is delivered to the initial retail purchaser, or on the date the Scooter/moped vehicle is placed in service as demonstrator, rental, lease, or company Scooter/moped vehicle prior to retail sale.

- 4) **COVERAGE.** Warranty defects shall be remedied during customary business hours at any authorized ETON America LLC Scooter/moped dealer located within the United States in compliance with the Clean Air Act and applicable regulation of the US EPA. Any part or parts replaced under this warranty shall become the property of ETON America LLC.
- 5) **OWNERS OBLIGATION.** The following obligations must be fulfilled by the owner to maintain the validity of the ETON America LLC Emission Control System Warranty:
 - a) Owner must deliver the scooter/moped vehicle to an authorized ETON America LLC Scooter/moped vehicle dealer or equally qualified service facility for inspection, maintenance service and adjustments according to the Periodic maintenance chart provided as part of, or supplemental to the Owner's manual. Optionally, the Owner may perform this maintenance only if it is within the scope of the Owner's technical and practical ability, keeping in mind some maintenance operations may require special tools or technical expertise beyond the scope of the average Owner. In any event, the inspection, maintenance and adjustments are to be performed at the Owner's expense.
 - b) Owner must present a copy of the proof of initial retail purchase date, issued at the time of purchase to an authorized ETON America LLC Scooter/moped vehicle dealer at the time warranty repairs are performed on the Scooter/moped vehicle. You may also be required to show that you have performed the required maintenance which is related to the alleged defect, so you should have detail receipts indicating that the required periodic maintenance has been performed in accordance with the periodic maintenance chart in your Owner's manual.
- 6) **LIMITATIONS.** This Emission Control System Warranty shall not cover any of the following:
 - a) Repairs or replacement required as a result of (i) accident, (ii) misuse or neglect, (iii) lack of reasonable and proper maintenance, (iv) repairs improperly performed or replacement improperly installed, (v) use of replacement parts or accessories not conforming to ETON America LLC specifications which adversely affect performance and/or durability, (vi) alterations or modifications not recommended or approved in writing by ETON America LLC, and/or (vii) use in competitive racing or related events.
 - b) Replacement of parts and other services and adjustments required for routine maintenance.
 - c) Any Scooter/moped vehicle on which odometer mileage has been changed so that the actual mileage cannot be determined.
- 7) **LIMITED LIABILITY.**
 - a) The liability of ETON America LLC under this Emission Control System Warranty is limited solely to the remedying of the defects in the materials or workmanship by any authorized ETON America LLC Scooter/moped vehicle dealer at its place of business during customary business hours. Please refer to ETON America LLC website: www.etonamerica.com. This warranty does not cover inconvenience or loss of use of the Scooter/moped vehicle, or transportation of the Scooter/moped vehicle to or from the ETON America LLC authorized dealer. ETON America LLC SHALL NOT BE LIABLE FOR ANY OTHER EXPENSE, LOSS OR DAMAGE, WHETHER DIRECT, INCIDENTAL, CONSEQUENTIAL OR EXEMPLARY ARISING IN CONNECTION WITH THE SALE OR USE OF OR INABILITY TO USE THE ETON America LLC SCOOTER/MOPED VEHICLE FOR ANY PURPOSE, SOME STATES DO NOT ALLOW THE EXCLUSION OR LIMITATION OF ANY INCIDENTAL OR CONSEQUENTIAL DAMAGES, SO THE ABOVE LIMITATION OR EXCLUSION MAY NOT APPLY TO YOU.

