

# **E-TON**

# **OWNER'S MANUAL**



Copyright ©2008-2009 ETON America, all rights reserved.

**DXL 90**

## NOTICE

- **OPERATOR ONLY**

This vehicle load limit and seating configuration are designed for operator only. It is not safe for carrying a passenger.

- **ADULT SUPERVISION AND INSTRUCTION ARE REQUIRED**

- **FOR OFF-ROAD USE ONLY**

This vehicle is designed and manufactured for off-road use only. Operation on public streets, roads or highways is illegal.

- **ALWAYS WEAR A HELMET**

- **READ THIS OWNER'S MANUAL CAREFULLY**

## CONTENTS

	Page		Page
NOTES FOR SAFETY.....	1	Parking.....	16
DESCRIPTION.....	6	Turning.....	17
Parts Location.....	6	MAINTENANCE.....	18
Serial Number.....	7	Maintenance Schedule.....	18
Parts Function.....	8	Spark Plug.....	19
Fuel.....	10	Air Cleaner.....	20
Engine Oil.....	12	Brakes.....	21
Tires.....	13	Drive Chain.....	21
OPERATION.....	14	Throttle Cable.....	22
Inspection.....	14	Battery.....	22
Starting Procedure.....	15	C.V.T. Air Filter.....	23
Break-in.....	15	SPECIFICATIONS.....	24
Riding.....	16	OUR WARRANTY.....	25
		WIRING DIAGRAM.....	26

---

## NOTES FOR SAFETY

---

- ★ Both the parents and their child must fully understand everything in this manual before riding.
- ★ This vehicle is for **OPERATOR-ONLY**.
- ★ This vehicle is only designed for operation on level, off-road surfaces, there are free of obstacles.
- ★ Riding this vehicle on public roads or highways is illegal. If crossing a public road is necessary, please get off this vehicle and push it across the road.
- ★ Don't allow your child to ride the ATV without your supervision.
- ★ Do not operate this vehicle while under **the influence** of alcohol or drugs. This can impair judgement and result in serious injury or even death.
- ★ Maintain a safe distance between your vehicle and other off-road vehicle.

★ **ALWAYS** wear a helmet, face shield, boots, gloves, and protective clothing.

★ **READ** the owner's manual carefully before riding.

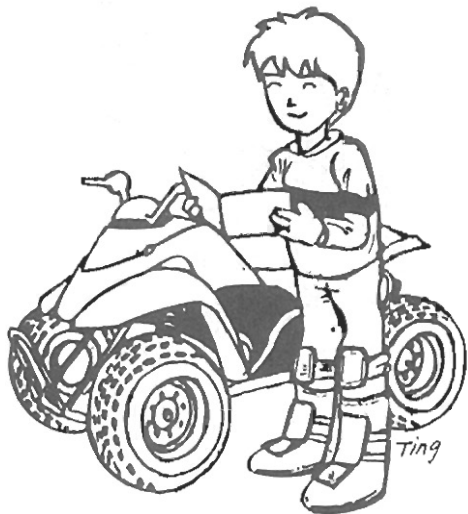
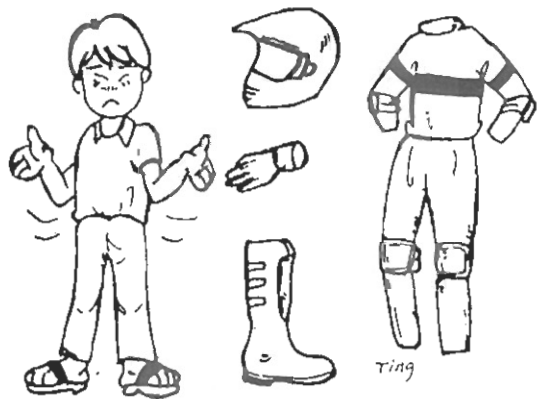

★ **NEVER** ride this vehicle unless it has been properly adjusted and maintained.



★ **WARM UP** your body with some exercises before riding.

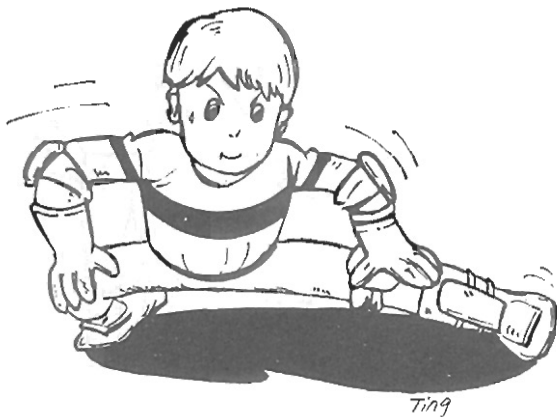

★ **LEARN** to ride this vehicle properly. Let a good coach teach you.



★ **ASK** your parent or instructor to refill the fuel tank.



- ★ **NEVER** run the engine in a close area. The exhaust gas of the engine contains poisonous **CARBON MONOXIDE**.

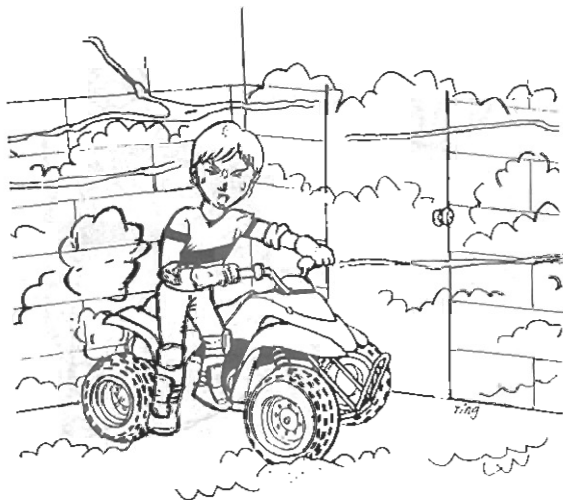

- ★ **DON'T** touch any part of the engine and muffler. They become very hot and touching them is dangerous for you.





## DESCRIPTION

### PARTS LOCATIONS

- (1) Fuel tank
- (2) Fuel valve
- (3) Front brake lever
- (4) Throttle lever
- (5) Rear brake / parking brake lever
- (6) Engine stop switch
- (7) Headlamp / Rear position lamp switch
- (8) Horn button
- (9) Start button

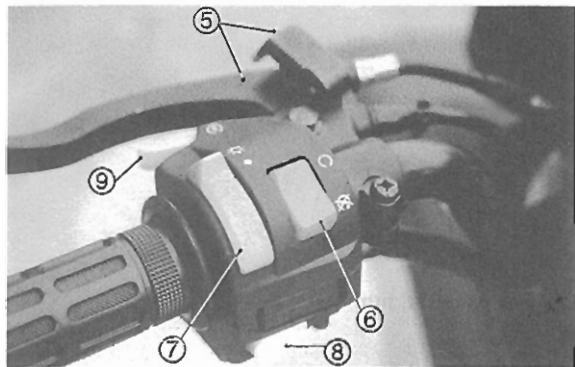
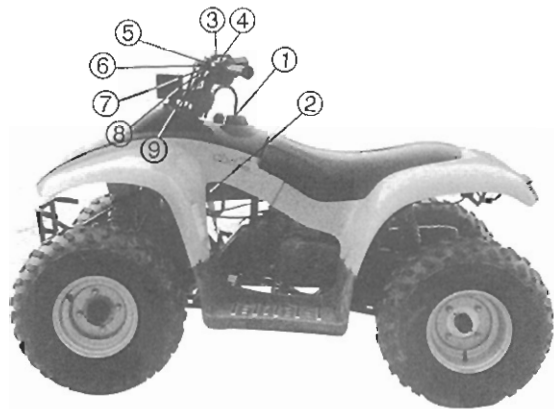

## SERIAL NUMBER

Please record the frame and engine serial numbers for future reference. The frame serial number (1) is stamped on the front of the frame.

The engine serial number (2) is stamped on the left side of the engine crankcase.

FRAME NO. \_\_\_\_\_

ENGINE NO. \_\_\_\_\_

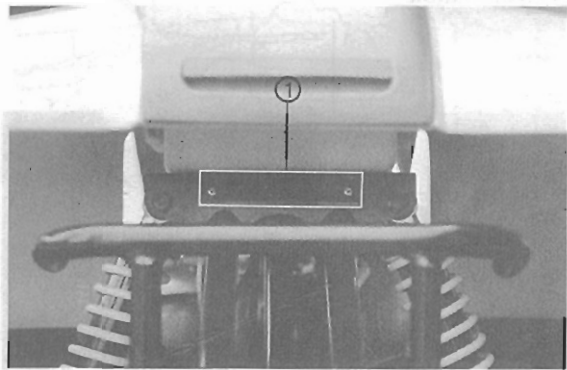

(1) Frame serial number

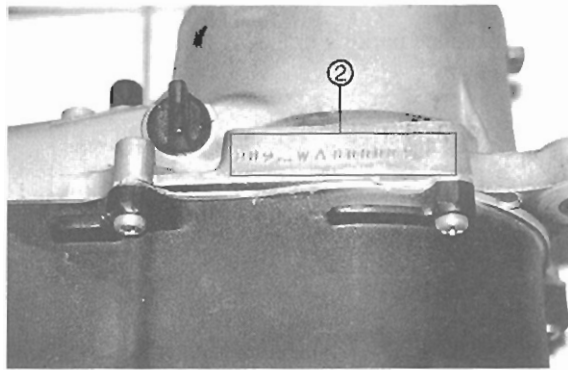

(2) Engine serial number

## PARTS FUNCTION

### Engine Stop Switch

The engine stop switch is on the left handlebar. When the switch is in the "OFF" position, the engine will not be operated. When the switch is in the "ON" position, the engine will be operated. This switch also can be used as a safety or emergency switch.

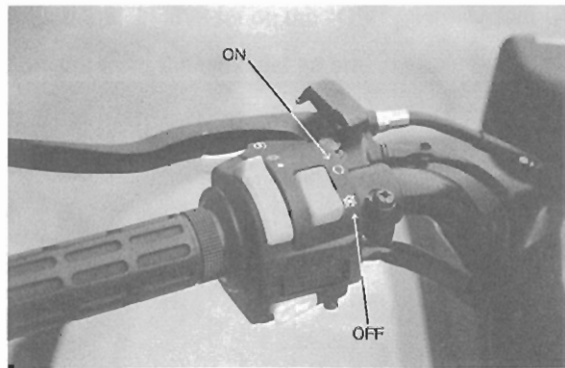

Engine stop switch

### Throttle Lever

The throttle lever is beside the right handlebar grip and is activated by the right hand thumb. To accelerate the vehicle, simply press the lever forward and open the throttle. To decelerate, release the lever and the spring tension will close the throttle automatically.

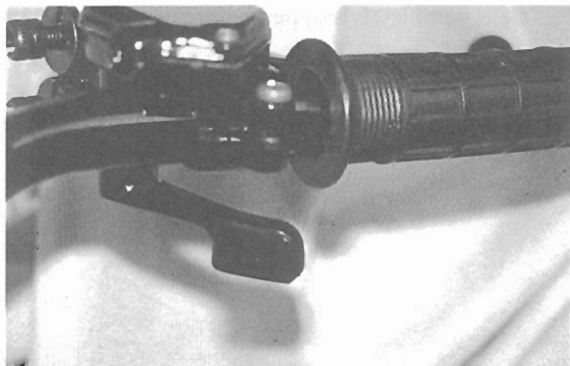

Throttle lever

## Rear Brake

The rear brake is the lever located on the left handlebar. When braking, squeeze this lever. This brake also has a locking feature that allows it to act as a parking brake. To use the parking brake, pull the left-brake lever back and lock it. Make sure the vehicle is completely stopped before using the parking brake. To release the parking brake, firmly squeeze the left-brake lever until the lock release.

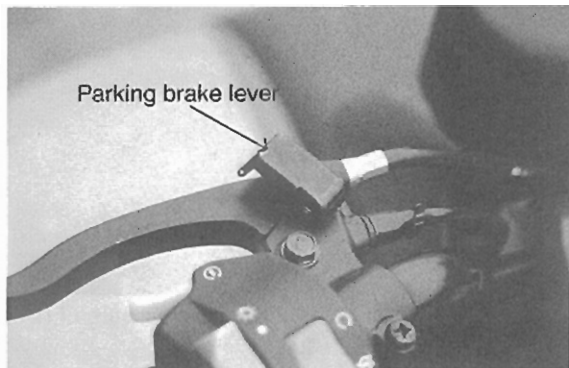

## FUEL

### Fuel Valve

The three-way fuel valve is on the left side of the vehicle, just below the seat.

With the fuel valve set on the “OFF” position, gasoline cannot flow into the engine carburetor.

With the fuel valve set on the “ON” position, fuel will flow out from the tank and go into engine.

When the fuel valve is set on the “RES” position, fuel will flow from the reserve fuel supply to the engine.

At this setting, the fuel tank will be refilled as soon as possible.

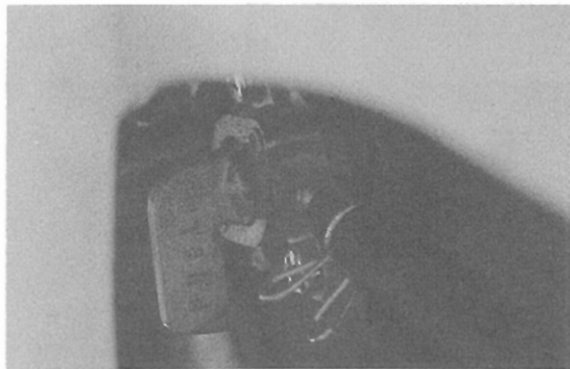

## Fuel Tank

Fuel tank capacity is 4.5 liters including 0.8 of a liter in the reserve supply.

Automotive gasoline with an octane level of 91 or higher may be used.

After refueling, be sure to tighten the tank cap firmly.



## ENGINE OIL

Two-stroke engine oil must be added to the oil tank periodically. Check the oil level in the oil tank every day before operating this vehicle.

If the oil supply to the engine is insufficient, the engine will stop operating until you replenish the oil. The oil tank is under the seat. You must unscrew the fixing screws under the seat and release the two screws between front and rear fenders then you can remove the seat and rear fender together.



## TIRES

Check the tire pressure frequently with an air pressure gauge. You should check the pressure before running the vehicle when the tires are cold. Tires should be inflated to the following recommended pressure.

- ★ The recommended pressure : 2.2 psi (15 kPa)
  - Max. pressure : 2.6 psi (18 Kpa)
  - Min. pressure : 1.8 psi (18 Kpa)
  
- ★ The pressure should be checked when the tires are “ cold ”, before running the vehicle.





### INSPECTION

Inspect your vehicle every day before you riding it. Checking your ATV takes only a few minutes and may save your life.

- ★ Check oil level in oil tank.
- ★ Check fuel level in fuel tank.
- ★ Check brake operation.
- ★ Check tires' condition and pressure.
- ★ Check the drive chain's condition and slack.
- ★ Check throttle for smooth opening and closing.
- ★ Check engine stop switch for good functioning.
- ★ Check steering to see that the wheels can turn properly.
- ★ Check all nuts, bolts and other fasteners.

## **STARTING PROCEDURE**

1. Parking the vehicle on a level surface and lock the parking brake.
2. Insert the ignition key into its switch and turn it to the "ON" position.
3. Turn the fuel valve to "ON".
4. Move the engine stop switch to "ON".
5. Push the throttle lever slightly.
6. Push the start button on the left handle bar.

## **BREAK-IN YOUR ATV**

During the first two weeks of riding, operate your new vehicle tenderly. Don't run it very fast and don't approach the maximum rpm.

Follow these guidelines will greatly enhance the long-term power and life of the engine.

## RIDING

Select a safe area with a level surface that is free of obstacles.

Under normal riding conditions, touching your feet to the ground for balance is not necessary.

Follow the following procedures to ride your ATV:

1. Start the engine by following the starting procedures on the preceding page.
2. After warm up the engine, release the parking brake. The vehicle is now ready for riding.
3. Increase engine speed by gradually opening the throttle.

## PARKING

1. Park on a level surface.
2. Stop the vehicle and move the engines stop switch to "OFF".
3. Lock the parking brake at the left handlebar.

## TURNING

The rider must learn to move his weight and control the throttle to allow the rear tires to turn properly. When turning, the wheels on the outside of the turn must travel a wider radius and thus a greater distance than the wheels on the inside of the turn. Since the rear axle does not permit a differing rate of wheel rotation, it is not enough to merely steering this vehicle into a turn.

To turn properly, steer in the direction of the turn and lean your body to the inside of the turn while supporting your weight on the outer footpeg. Use the throttle to maintain power throughout the turn.

Incorrect turning may cause the front wheels to slide to straight ahead. If this should occur, close the throttle and stop. Avoid braking or accelerating until you have regained directional control in order to avoid skids while traveling on slippery terrain.



## MAINTENANCE

### MAINTENANCE SCHEDULE

The maintenance intervals in table below are based upon average riding conditions. Riding in unusually dusty areas requires more frequent servicing

	INITIAL SERVICE (First week)	REGULAR SERVICE (Every 30 operating days)	EVERY YEAR
FUEL LINE			I
THROTTLE OPERATION	I	I	
AIR CLEANER		C	
SPARK PLUG		I	
CARBURETOR IDLE SPEED	I	I	
DRIVE CHAIN	I,L	I,L	
BRAKE SHOE WEAR		I	I
BRAKE SYSTEM	I	I	
NUT, BOLT,FASTENER	I	I	
WHEEL	I	I	
STEERING SYSTEM			I
SUSPENSION SYSTEM			I
C.V.T. AIR FILTER		C	

Note – I : Inspect and Clean, Adjust, Lubricate or Replace, if necessary

C : Clean

L : Lubricate

## SPARK PLUG

Standard spark plug : NGK BPR7HS or BP7HS

1. Disconnect the spark plug cap.
2. Clean up dirt from around the spark plug base.
3. Remove the spark plug.
4. Inspect the plug electrodes for wear. If the electrodes and insulator tip appear unusually fouled or burned, change a new one.  
Discard the spark plug if there is apparent wear or if the insulator is cracked or chipped.
5. The spark plug gap shall keep in 0.6–0.7 mm. If adjustment is necessary, bend the side electrode carefully.
6. Install the spark plug, screw it in finger tight and then tighten with the plug wrench another 1/2 turn to compress the washer.



## AIR CLEANER

The air cleaner will accumulate dust and must be cleaned periodically. If riding in very dusty area, the filter must be cleaned more frequently.

To clean the filter

1. Remove the air cleaner cover.
2. Remove the filter from the air cleaner case.
3. Wash the filter element in a non-flammable or high flash-point solvent. Soak the element in clean oil until saturated, then squeeze out the excess oil.
4. Let the filter element dry and reinstall it.

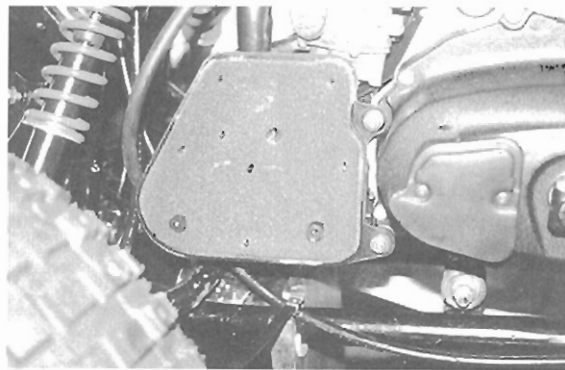

## BRAKES

Check the brake cable for kinds or signs of wear that could cause sticking or failure.

Lubricate the brake cable with a available cable lubricant to prevent premature wear or corrosion.

Make sure the brake arm, spring, rod and fasteners are in good condition.

## DRIVE CHAIN

The drive chain will wear with use and requires periodic adjustment. Remove the chain cover, measure the amount of chain slack to check the chain tension.

The amount of slack should be 10-20 mm.

The chain slack can be adjusted by loosn the lock nuts and move the chain tensioner plate. Don't forget tighten the lock nuts well. Sometimes, it needs to lubricate the chain. The SAE 80 or 90 gear oil is recommended.

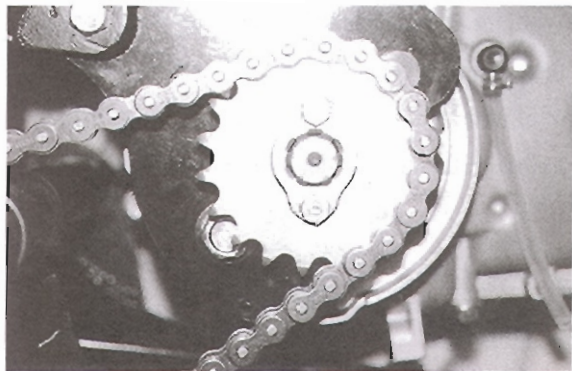



## THROTTLE CABLE

Inspect the throttle cable's condition and operation. Replace the cable if it has become worn or kinked. Lubricate the cable with lubricant to prevent premature wear or corrosion. Adjustments can be made with the adjuster beside the throttle lever. Loosen the lock nut and turn the adjuster. Free play of 5-10 mm should be maintained.

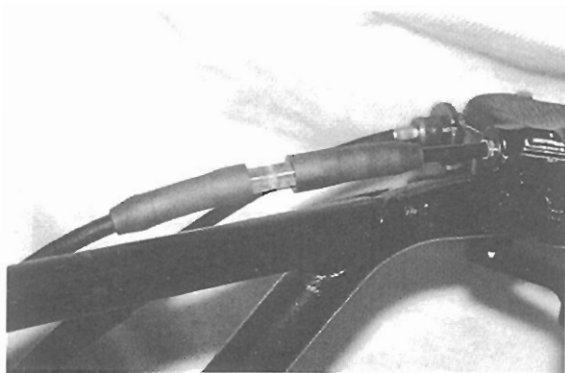

## BATTERY

When reinstalling the battery, be sure to connect the red cable to the positive (+) lead and the black cable to the negative (-) lead.

When the battery no longer can hold a charge, replace it. The battery should be replaced every three years as a normal service.

## C.V.T. AIR FILTER

The C.V.T. air filter will accumulate dust and must be cleaned periodically. If riding in very dusty area, the filter must be cleaned more frequently.

To clean the filter

1. Remove the air cleaner cover.
2. Remove the filter from the air filter case.
3. Wash the filter element in a non-flammable or high flash-point solvent.
4. Let the filter element dry and reinstall it.

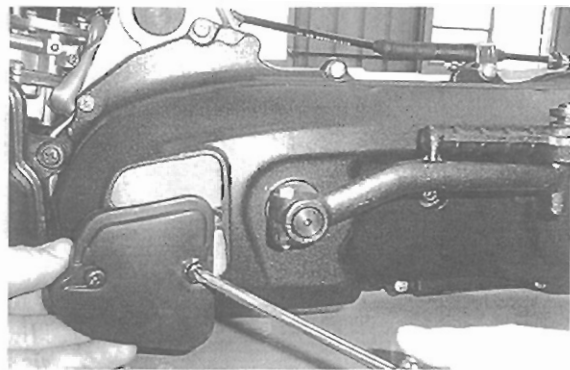

---

## SPECIFICATIONS

---

### ATV TYPE

**DXL90**

### ENGINE

Type	Air-cooled 2-stroke
Displacement	82.5 c.c.
Bore and Stroke	φ 50.0*42.0 mm
Compression	5.8:1
Oil tank capacity	1.0 liter
Transmission	Automatic (C.V.T. V-belt)

### CHASSIS

Overall Length	1510 mm
Overall Width	860 mm
Overall High	950 mm
Wheelbase	1040 mm
Dry weight	102 kg
Fuel Tank capacity	5 liter

### SUSPENSION

Front	Dual Arm
Rear	Swing Arm

### TIRE

Front	19*7-8
Rear	19*7-8

## **OUR WARRANTY**

### **OBLIGATION**

Our obligation under this warranty is limited to repairing or replacing, at our option, any part that is proven to be defective in material or factory workmanship under normal use for the applicable period stated below. Parts will be repaired or replaced only during warranty period.

### **OBLIGATION OF VEHICLE OWNER**

You must, at your own expense, perform all the scheduled maintenance in accordance with the maintenance schedule in this owner's Manual.

### **WARRANTY TIME PERIOD**

This warranty covers this vehicle for a period of six months from the date of purchase.

### **EXCLUSIONS**

This warranty does not cover failures other than those resulting from defects in material or factory workmanship. This warranty does not cover replacement of expendable maintenance items made in connection with required maintenance services including, but not limited to: coolant, spark plugs, gaskets, belts, filters, lubricants, and hoses. In addition, this warranty does not extend to tires. Finally, use of this vehicle for racing, competition, and commercial uses, including rentals, will VOID this warranty.

# WIRING DIAGRAM

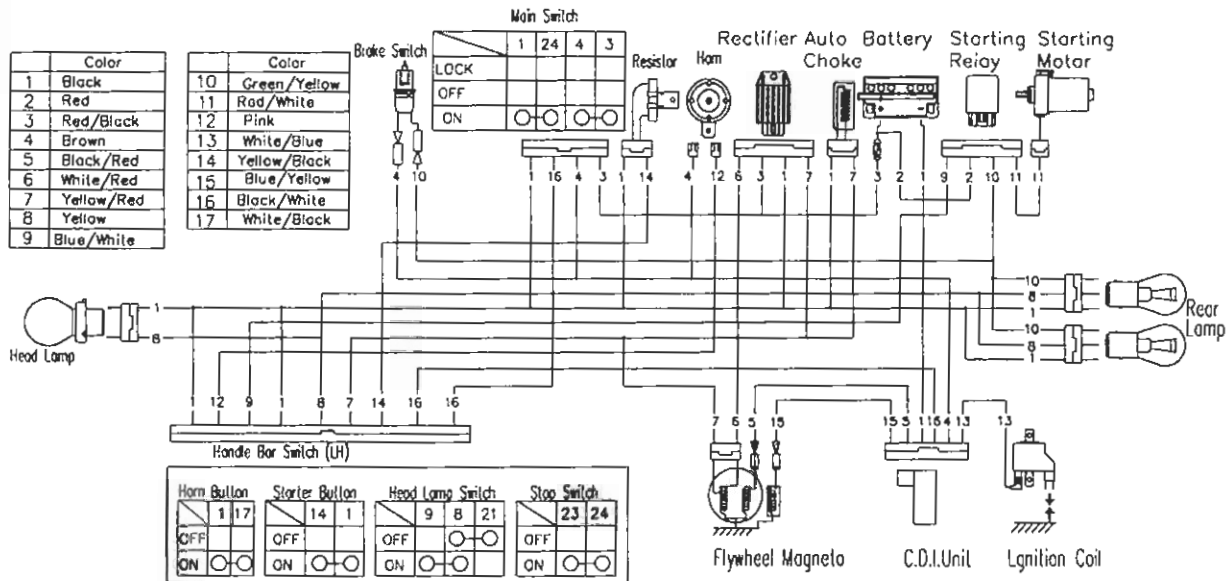



## E-TON DYNAMICS TECHNOLOGY INDUSTRY CO., LTD.

ADD. : 8582 N.W. 70 St. Miami, FL 33166, U.S.A.

TEL : (305) 471-0288 (Rep.)

FAX : (305) 471-0289

E-MAIL : [kpjii@bellsouth.net](mailto:kpjii@bellsouth.net)

Contact Person : Michael Wu

HOME PAGE : <http://www.kpjii.com.tw>

1999 AUGUST

Copyright ©2008-2009 E-TON America, all rights reserved.

H9900-9FA0-0000