

gruppo industriale agrafi-GARELLI monticello brianza (co) - italy

MO-PEDS **GARELLI 50 cc**
SINGLE SPEED AUTOMATIC TRANSMISSION



MONZA G.T.

25-30 m.p.h.

WORLD CHAMPION
1982 - 83 - 84 - 85

OWNER'S MANUAL

Tampering with noise control system prohibited:

federal law prohibits the following acts or the causing thereof:

(1) The removal or rendering inoperative by any person other than for purposes of maintenance, repair, or replacement, of any device or element of design incorporated into any new vehicle for the purpose of noise control prior to its sale or delivery to the ultimate purchaser or while it is in use, or (2) the use of the vehicle after such device or element of design has been removed or rendered inoperative by any person.

Some examples of acts presumed to constitute tampering follow:

- (1) removal of muffler system or any part thereof;
- (2) removal of airbox, air filter, or any part thereof;
- (3) replacement of original exhaust system or muffler with any component or part not in compliance with federal regulations;
- (4) modification by drilling, cutting, or altering in any manner the exhaust system or air intake system if such modification results in increased noise levels.



CONDITIONS OF WARRANTY

AGRATI-GARELLI Corporation of America distributor for Garelli motorized bicycles or its authorized selling dealer makes no warranties, expressed or implied, on the Garelli motorized bicycle except as hereinafter specifically set forth. The warranty contained herein shall inure only to the benefit of an original purchaser of a Garelli from an authorized Garelli dealer.

AGRATI-GARELLI Corporation of America warrants that the Garelli motorized bicycle including all equipment and accessories thereon (except ball bearings, cables, spark plugs, tires, tubes, electrical equipment, light lenses, controls) manufactured, imported or supplied by AGRATI-GARELLI Corporation of America to be free from defects in material and workmanship under normal use and service for a period of 4 months after delivery to the original purchaser by an authorized Garelli dealer.

Under the terms of this warranty, it shall be the sole option of AGRATI-GARELLI Corporation of America to repair or replace any part or parts which are returned to an authorized Garelli dealer at its place of business which shall disclose to the satisfaction of AGRATI-GARELLI Corporation of America to have been defective. The repair or replacement of defective parts under this warranty will be made without charge for parts and labor except however any fuel or lubricants, transportation charges shall be at the expense of the original purchaser.

The terms and conditions of this warranty shall be void and not applicable to any Garelli motorized bicycle which has been: (1) subject to abuse, misuse, negligence or alteration; (2) use of nonoriginal Garelli parts; (3) improper repairs or maintenance or evidence of repairs not properly performed by persons other than Garelli dealers; (4) evidence that the Garelli has been used in races or competition; (5) the use of oil and lubricants which were not of the prescribed quality, quantity or grade; (6) improper fuel mixture ratio; (7) failure to follow breaking in instructions.

This warranty shall not apply to any Garelli which has been damaged by accident, acts of God, fire, flood or other casualties which is beyond the control of AGRATI-GARELLI Corporation of America. AGRATI-GARELLI Corporation of America shall not be liable for any damages because of the loss of use, loss of business or profits or for any other type consequential or incidental damages arising as a result of a defect in the Garelli motorized bicycle.

THE ABOVE CONSTITUTES ALL WARRANTIES ON THE GARELLI MOTORIZED BICYCLE AND THERE ARE NO OTHER WARRANTIES EITHER EXPRESSED OR IMPLIED INCLUDING ANY IMPLIED WARRANTY OF THE MERCHANTABILITY OR FITNESS OF THE GARELLI MOTORIZED BICYCLE FOR ANY PARTICULAR PURPOSE.

TABLE OF CONTENTS

Vehicle Identification	Page 7
Specifications	» 8
Location of Controls	» 10-11
Controls	» 12
Starting	» 16
Breaking-in	» 18
Fuel and Oil Mixing	» 18
Electrical System	» 20
Tools	» 21
Maintenance	» 22
Periodic Inspections	» 30-
Trouble Shooting	» 32
Consumer Information	» 34

VEHICLE IDENTIFICATION

The frame number can be found on the left side of the frame head.

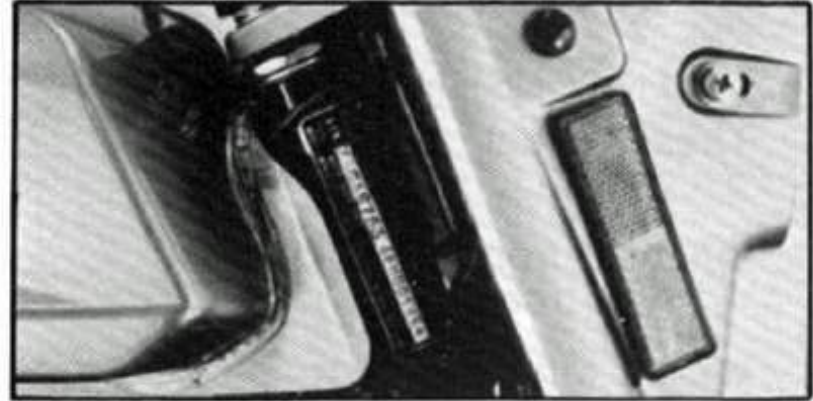

Pict. 1

The engine number can be found on the front right side of the engine.



Pict. 2

SPECIFICATIONS

DIMENSIONS AND WEIGHT

Tires: front	2 1/2 x 16 in.
rear	2 1/2 x 16 in.
Inflation: front	21–25 lbs. sq. in.
rear	31–35 lbs. sq. in.
Weight (dry)	61 kg. (134 lbs.)
Overall Length	1,76 m (69,5 in.)
Overall Width	0,75 m (29,7 in.)
Overall Height	0,97 m (38,4 in.)
Wheel Base	1,14 m (44,9 in.)

LIQUID CAPACITIES

Gas Tank	8 litres (2,2 gals)
Gearbox	350 cc (12.0 ozs.)

ENGINE

Type	2 cycle, single cylinder, air cooled, piston valve
Bore	40 mm

Stroke	39 mm
Displacement	49 cc
Weight (dry)	13 kg. (28 lbs.)

ELECTRICAL

Ignition System	Mechanical point
Ignition Timing	1,8 mm B.T.D.C. 23 degrees B.T.D.C.
Spark Plug gap.	0,5 mm (0.020 in.)
Head Lamp	6 V.-25/25 W.
Tail Light Bulb	6 V., 4 W.
Stop Light Bulb	6 V., 10 W.

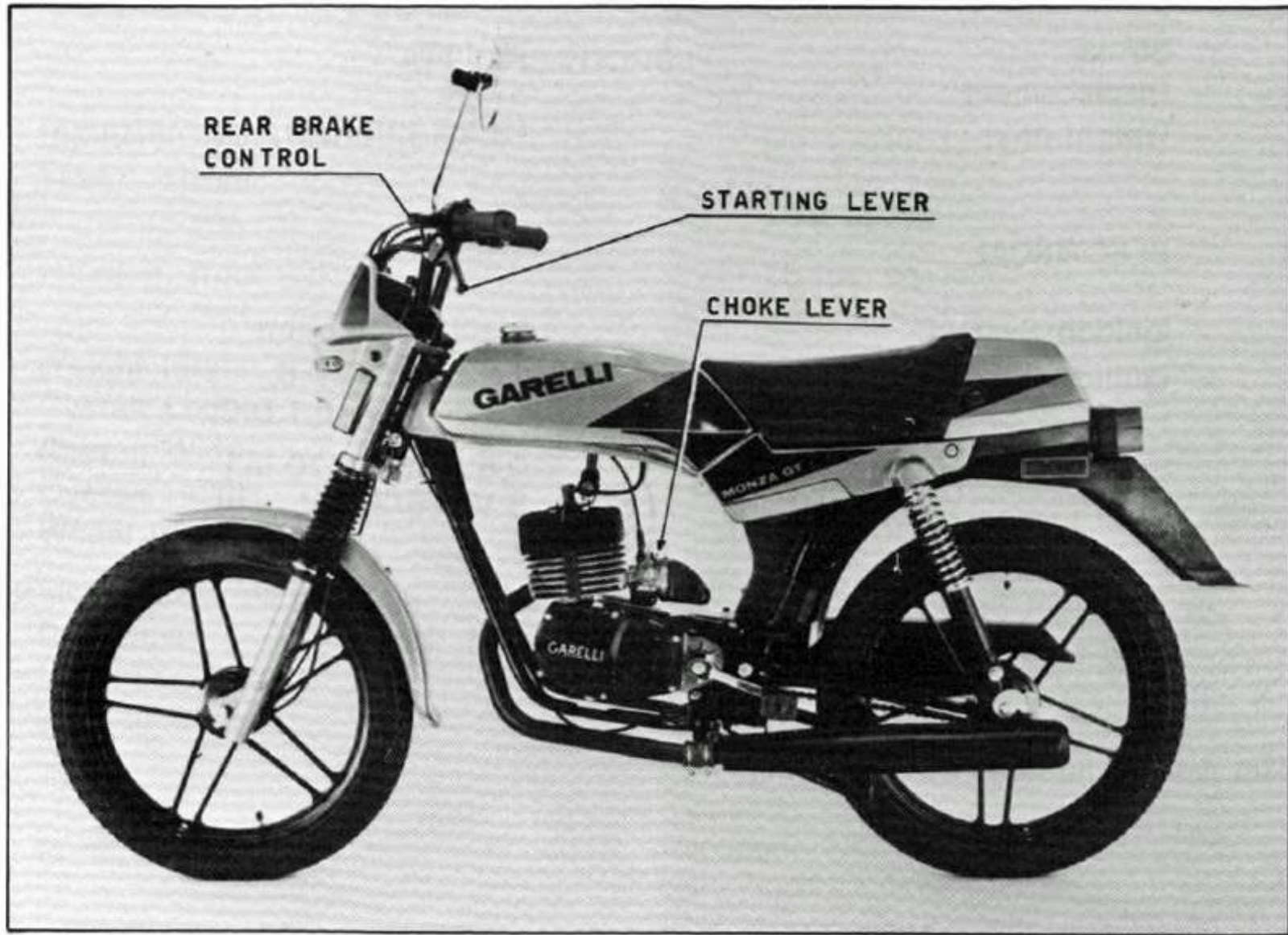

LOCATION OF CONTROLS

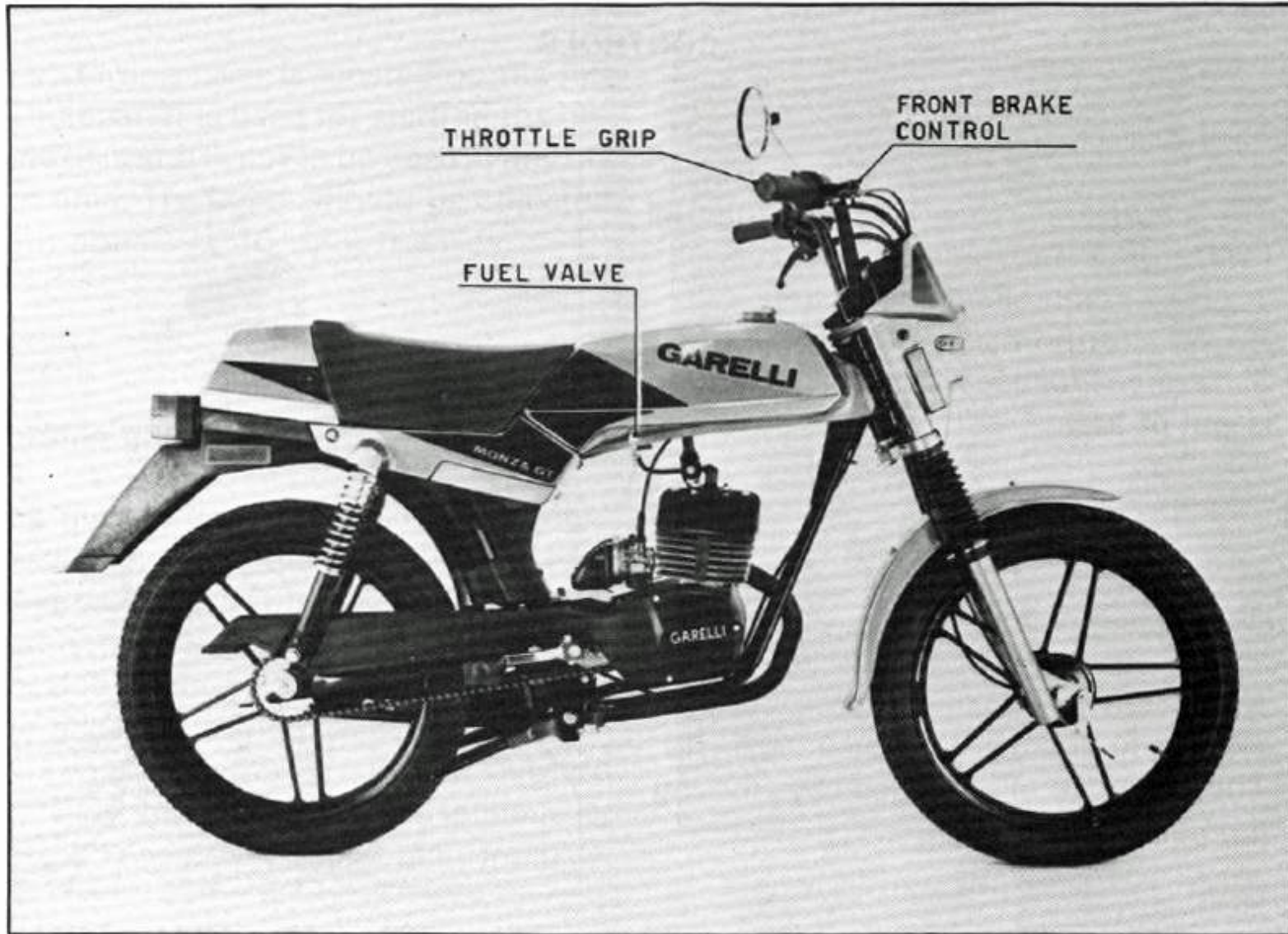

CONTROLS

Fuel valve

The fuel valve is located under the fuel tank on the right side.

- 1 - off - when bike is not in use
- 2 - on - for normal running
- 3 - reserve - for use when « on » position is out of fuel

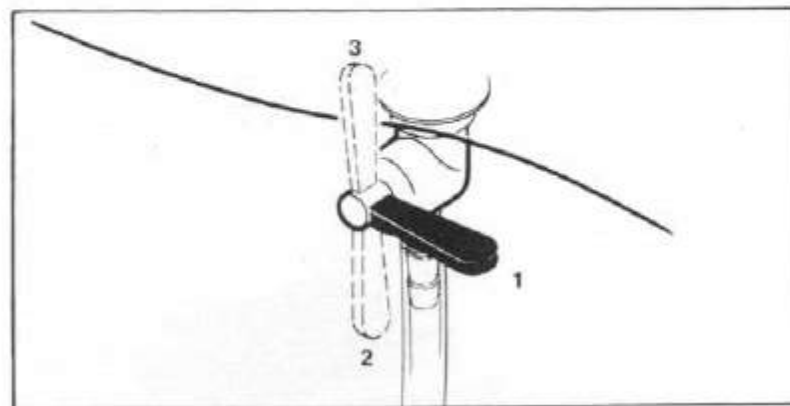

Carburetor choke lever

When starting the engine cold, it is necessary to engage the choke lever. (L)
The choke is disengaged by turning the throttle fully open.

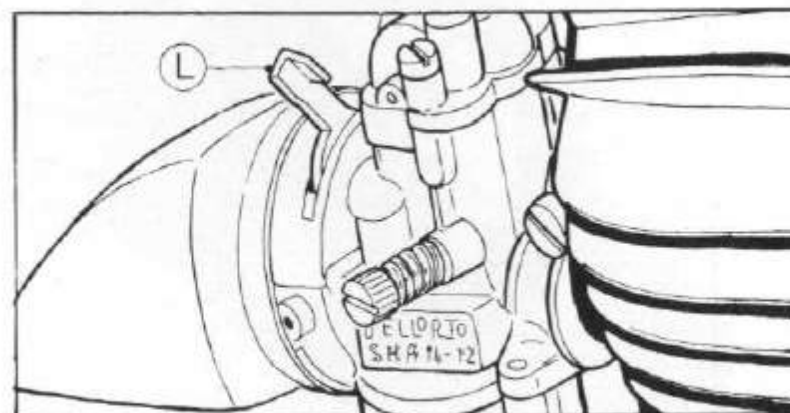

Starting Lever

The starting lever is located on the left handlebar. It is used for starting the engine only and is not to be used at any other time. The cable should be adjusted with about $\frac{1}{4}$ " (6 mm) freeplay.

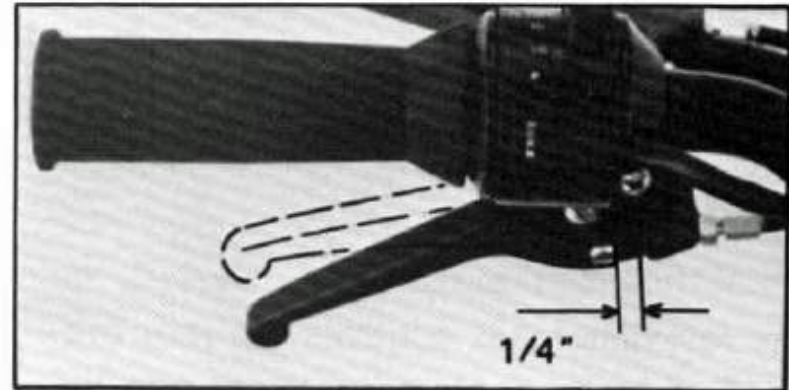

Pict. 7

Throttle grip

The throttle grip is located on the right handlebar. When the grip is twisted toward you, the throttle valve in the carburetor opens, accelerating the engine. Throttle cable adjustment is done with the adjuster located on top of the carburetor. Turning the adjuster outward tightens the cable. The cable housing should have about $\frac{1}{8}$ " (3 mm) freeplay.

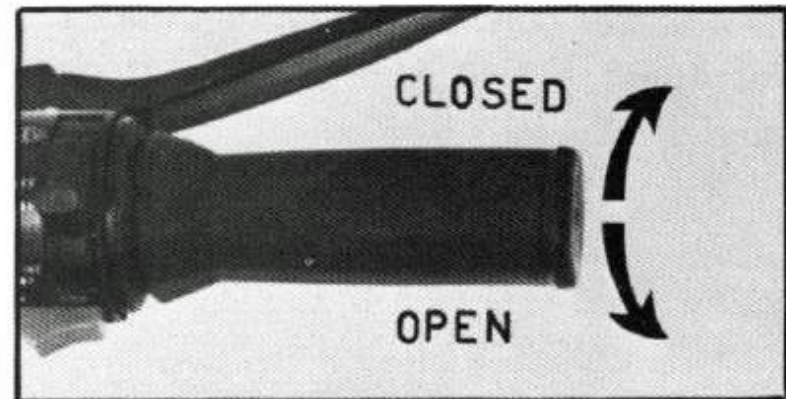

Pict. 8

Front and rear brake controls

The lever (A) on the right handlebar controls the front brake. The lever (B) on the left handlebar controls the rear brake. For brake cable adjustment use the adjuster located on each wheel hub at the end of the cable housing. Screwing the adjuster outward will tighten the cable. About $\frac{1}{4}$ " (6 mm) freeplay at the lever should be obtained.

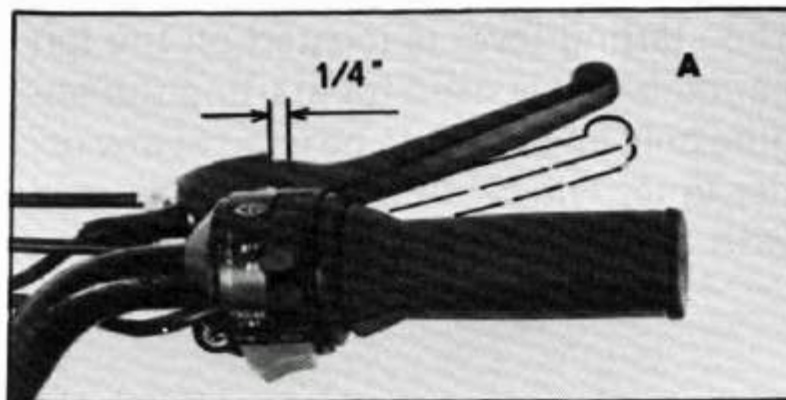

Pict. 9

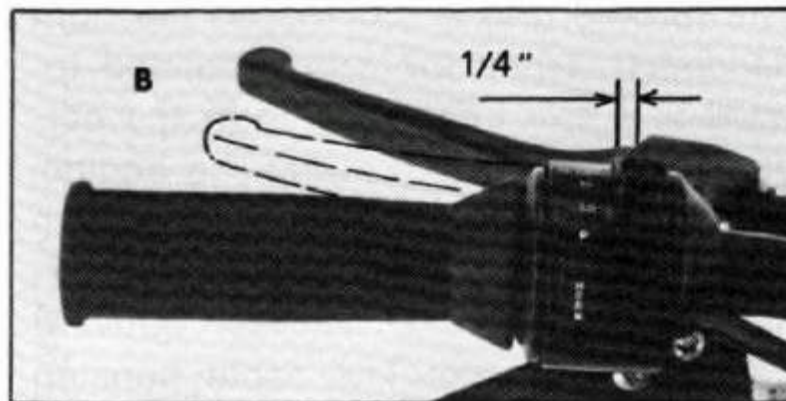

Pict. 10

Engine switch

The engine run switch is located on the right side of the handlebar.

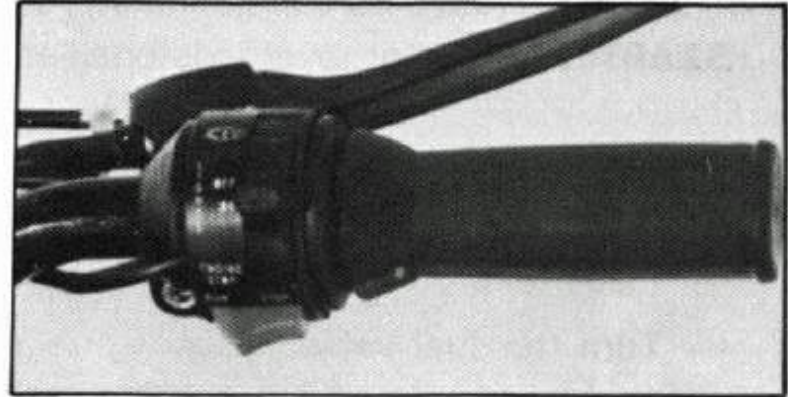

Pict. 11

Lights/horn switch

The switches for the running lights and the horn are combined into a single switch located on the left side of the handlebar. The lever switch is for the lights and the button switch is for the horn.

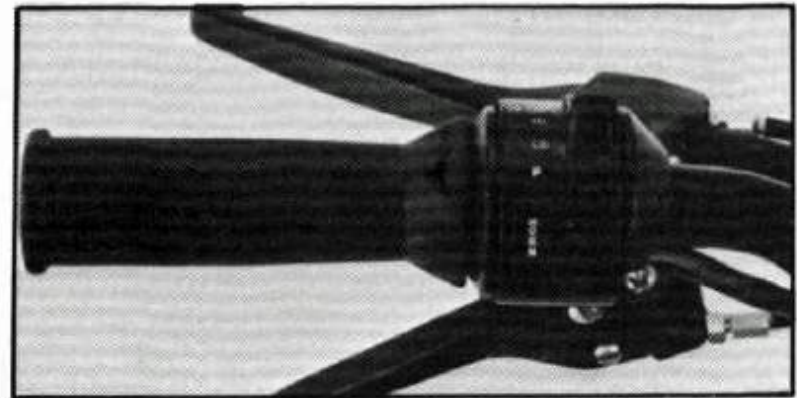

Pict. 12

STARTING

- Place bike on kickstand so that the rear wheel is able to spin freely.
- Turn the fuel valve to the « on » position.
- Engage the choke lever located on the carburetor.
- Turn the engine switch to « run ».
- Bring the left pedal to the top.
- Turn the throttle grip about one-third open.
- Pull the starting lever and hold in.
- Place foot firmly on pedal and push downward quickly.
- Release the starting lever as soon as the pedal reaches the bottom.
- Allow the engine to warm up for a few moments then turn the throttle fully open so as to release choke.
- Apply brake on the rear wheel and, while the engine **is running idle**, put the moped down the stand.

Note: It is also possible to start the moped by pedalling like on a bicycle and, after getting sufficient speed, squeezing the handlebar lever to engage the clutch.



Pict. 13

BREAKING-IN

The Garelli 49 cc engine is manufactured using the latest in two-stroke engine technology. It is advisable that the machine be operated at reduced speed ($\frac{3}{4}$ of max. speed) for the first 500 miles. This practice will help all moving parts to break-in and will also assist in acquainting you with the machine.

FUEL AND OIL MIXING

The Garelli 49 cc engine is of the two-stroke design, which requires a lubricating oil to be mixed with the gasoline for proper engine component lubrication.

CAUTION: A mixture containing too little oil will cause overheating of the engine. Too much oil will cause excessive carbon formation resulting in pre-ignition, fouled spark plug and loss of power.

Engine oil

The following brands of oil are highly recommended for use in the Garelli engine.

American Garelli

Golden Spectro

Pre-mixing instructions

GASOLINE	OIL	
	Break-in (3%)	Thereafter (2%)
0.25 (1/4) gal or 1 qt	1. oz	0.2/3 oz
0.33 (1/3) gal	1.1/3 oz	0.7/8 oz
0.50 (1/2) gal or 2 qts	2. oz	1.1/3 oz
0.65 (2/3) gal	2.2/3 oz	1.3/4 oz
0.75 (3/4) gal or 3 qts	3. oz	2. oz
1.0 gal or 4 qts	4. oz	2.2/3 oz

To mix the gasoline and oil, always use a separate, clean container. Pour the full amount of oil required for the total mixture into the container, add approximately half the amount of gasoline to be mixed and shake thoroughly. Add the remainder of the gasoline and again agitate the container.

ELECTRICAL SYSTEM

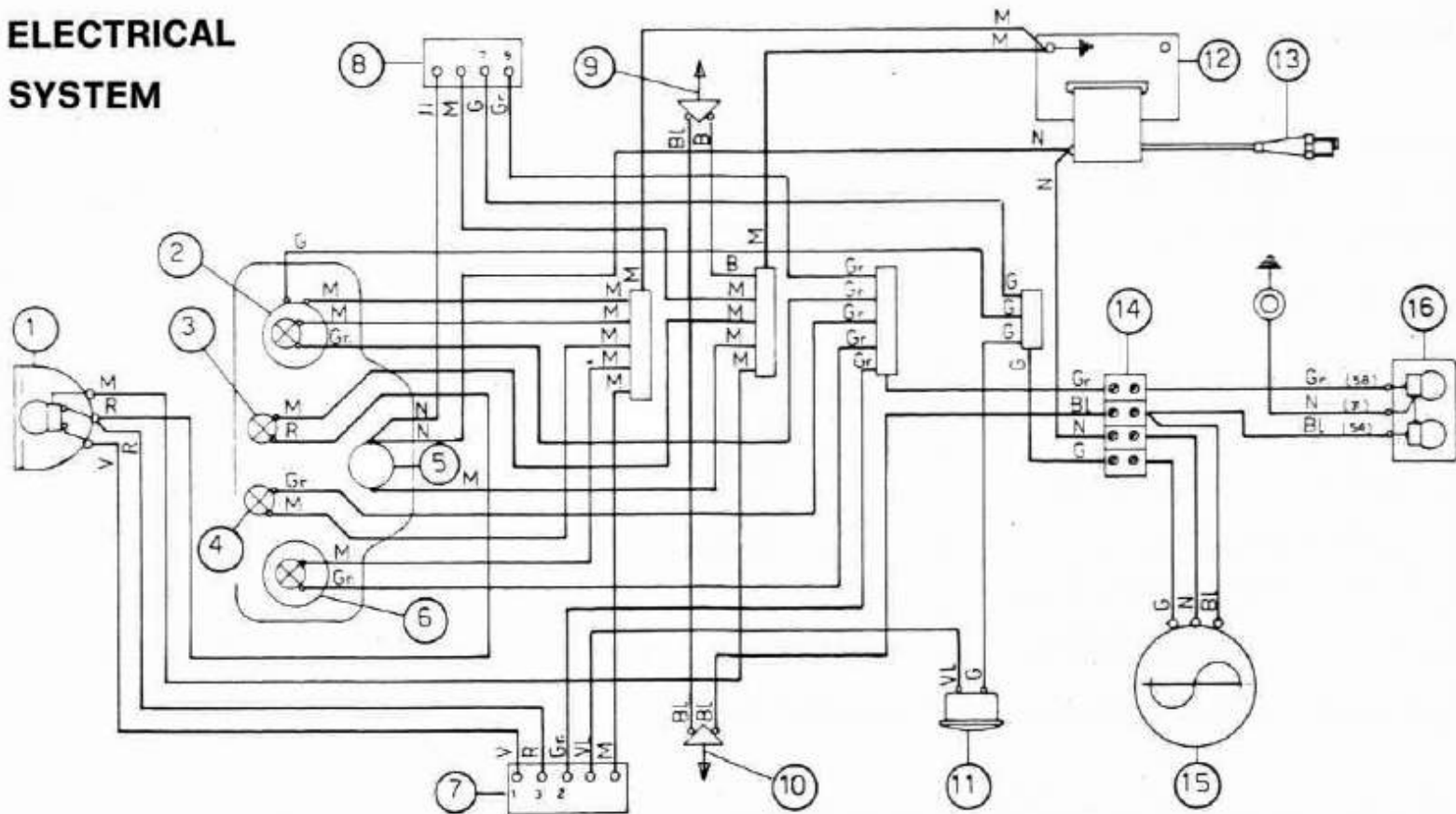

- 1 - Head lamp
- 2 - Engine speed indicator
- 3 - Blue warning light
- 4 - Green warning light
- 5 - Circuit breaker
- 6 - M.P.H.
- 7 - Switch
- 8 - Switch

- 9 - Stop switch
- 10 - Stop switch
- 11 - Horn
- 12 - Coil
- 13 - Spark plug
- 14 - Junction block
- 15 - Flywheel magneto
- 16 - Tail lamp

- B = White
 - Bl = Blue
 - G = Yellow
 - Gr = Grey
 - M = Brown
 - N = Black
 - R = Red
 - V = Violet
- } LEADS COLOUR

TOOLS

8 mm wrench

10 mm wrench

13 mm wrench

17 mm wrench

5 mm Allen wrench

Spark plug wrench

Assorted screwdrivers

TIGHTENING TORQUES FOR NUTS.

Cylinder head nuts 3,31 ÷ 4,41 lb.

Clutch nut 6,62 ÷ 7,72 lb.

Driver gear nut 9,8 ÷ 11 lb.

MAINTENANCE

Chain

To adjust the drive chain use a 17 mm wrench to loosen the rear axle nuts. Rotate the adjusting cams on each side taking care to keep the wheel aligned straight. There should be approximately $\frac{1}{2}$ " (10 mm) play in the chain (see illustration). Tighten both 17 mm axle nuts and recheck the chain for proper chain play.

NOTE: It is important to keep the chain cleaned and lubricated (a chain lubricant is recommended). This should be done at 300 mile (500 km) intervals.

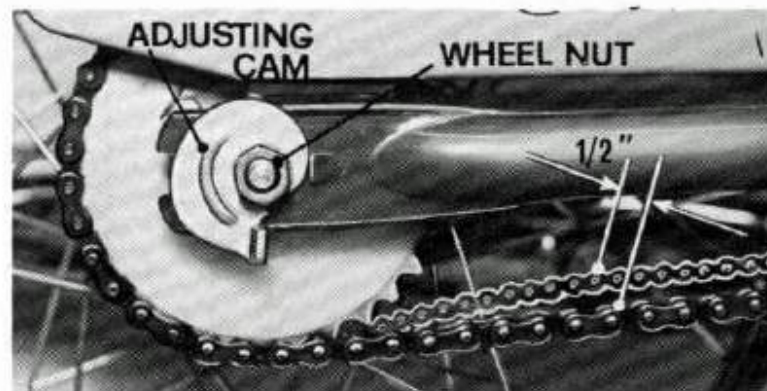

Pict. 15

Flywheel magneto

The engine right side cover must be removed for points and timing adjustments. The points and timing are adjusted through the flywheel windows with the flywheel remaining on the engine.

Points adjustment

Rotate the flywheel until the points gap is in the widest position. At this point measure the points gap.

Points Gap (1) - .014" - .018"
(0,35 - 0,45 mm)

To change the point setting loosen the set screw (2) (see illustration). Wedge a small-blade screwdriver between the notch in the points and the pins on the stator plate. Turning the screwdriver clockwise will open the points gap and turning counter-clockwise will close it. When satisfied that the gap is set correctly, tighten the set screw and check the gap once again.

NOTE: It is helpful to have the bike at a comfortable working level with good lighting.

Timing adjustment

To check the timing rotate the flywheel

in the counter-clockwise direction until the contact points just begin to open. When the points just begin to open the timing marks on the flywheel (3) and the crankcase (4) should line up. If they do not, the stator plate may be rotated by loosening the two fastening screws. This can be done through the windows on the flywheel so that it is not necessary to remove the flywheel. After obtaining the correct timing tighten the two fastening screws.

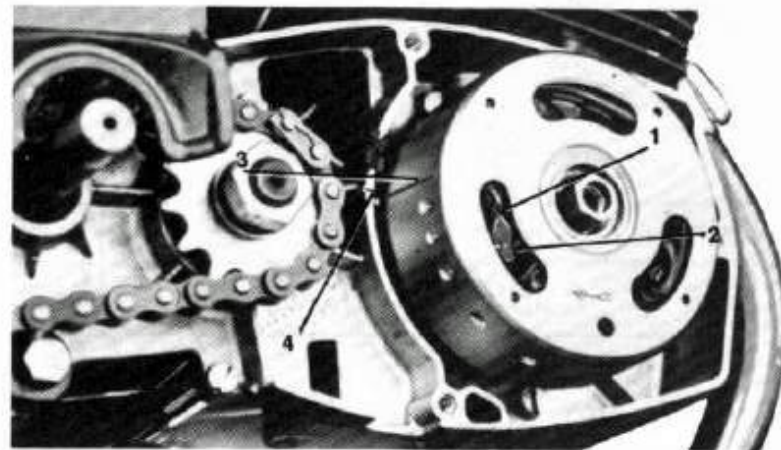

Pict. 16

Clutch

The clutch is located in the crankcase housing on the left side of the engine, is automatic and operates in an oil bath. This automatic clutch-expansion type is formed by one ring of special rubber having particular characteristic in order to avoid any noise and increase its duration. No adjustment are required also after a long use.

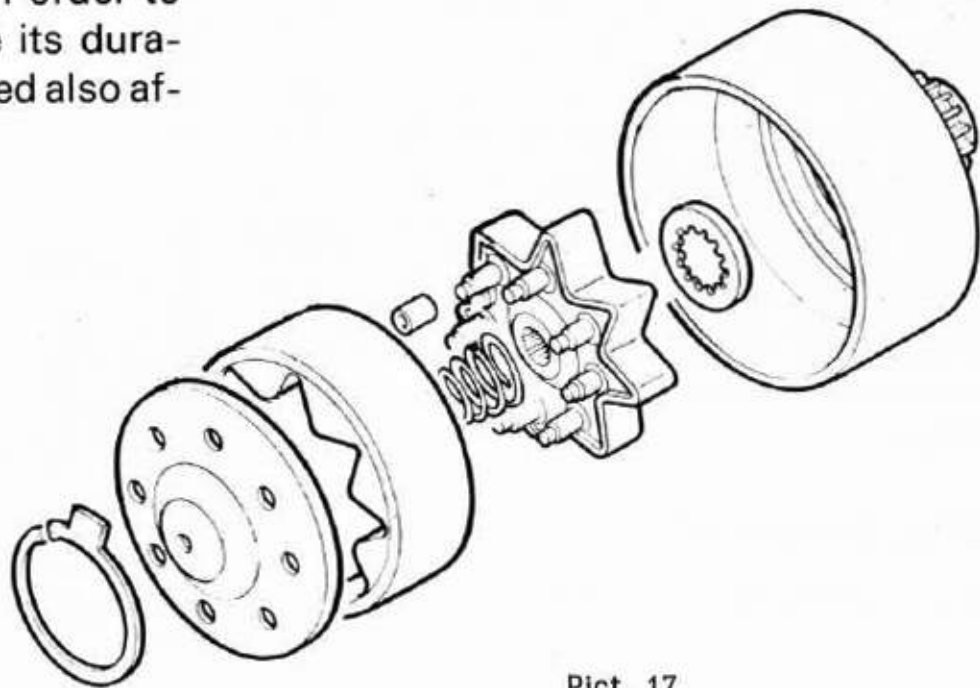

Pict. 17

Spark plug

The spark plug should be carefully cleaned and gapped every 750 to 1,000 miles. The spark plug gap tolerance is $.020'' - .024''$ (0,5 - 0,6 mm). Since the gap will widen under normal use, it is best to set it at the lower setting of $.020''$ (0,5 mm).

The plug value greatly depends on how the engine is employed. It may be necessary to use a value other than that suggested in the table.

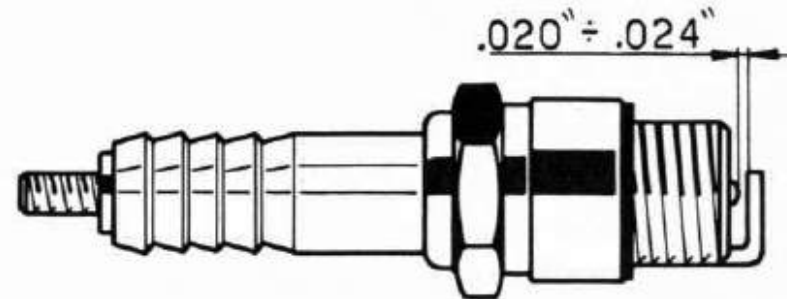

Pict. 18

Speed	Bosch	NGK	Champion
	W 7C	B6ES	N5

Carburetor

Air filter:

Remove the plastic air intake cover (F). Remove the air filter (A) and clean with gasoline or similar agent. Before replacing the air filter in the carburetor, make certain that it is dry.

Jet:

Remove the bottom bowl of the carburetor (E). Remove the brass jet (D) and clean with gasoline or similar agent. Blow out excess cleaning agent (making sure that the jet hole is clear) and replace.

Fuel filter:

Remove the filter cover (B) and filter (C). Clean filter with gasoline or similar agent and replace in carburetor.

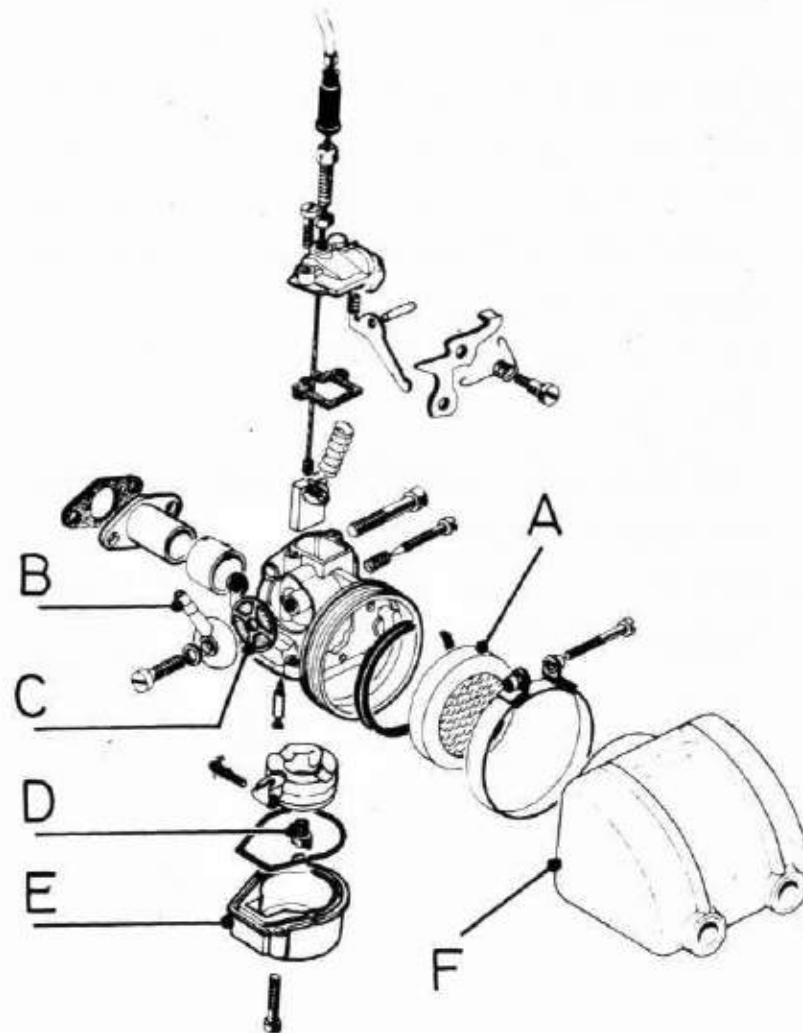

Front wheel

Removal:

Disconnect the speedometer and brake cables (10 mm wrench). Remove the two front axle nuts (17 mm wrench) and washers (A).

The wheel may now be removed.

NOTE: When the front wheel is removed the bike will be unbalanced. Be careful to gently lower the bike to rest on the front fork.

Re-assembly:

Re-assemble in reverse sequence making certain that:

- the speedometer drive pin is located in the hub slot and the speedometer cable is in the correct position;
- the front brake cable is properly connected and adjusted.

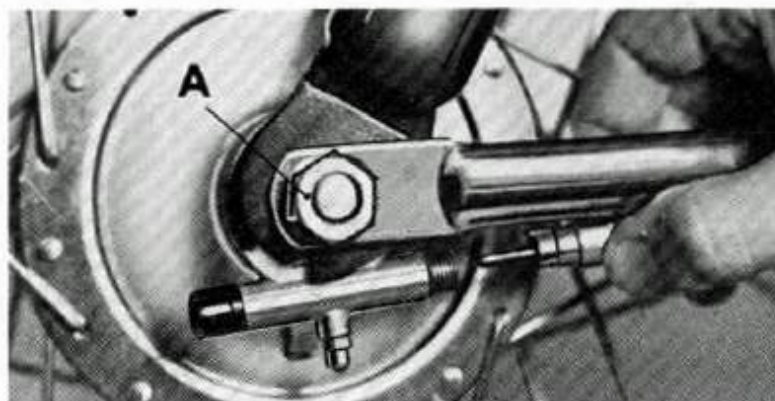

Pict. 20

Rear wheel

Removal:

Disconnect the brake cable (A) (10 mm wrench).

Loosen the two axle nuts (B) (17 mm wrench).

Push the wheel forwards as far as possible and remove the chain. If the amount of slack needed for removal can not be obtained by sliding the wheel forward then the master link must be removed. The wheel will now slide off.

Re-assembly:

Re-assemble in reverse sequence making certain that:

- the arm of the brake hub is seated over the stud located on the inside of the left swingarm; (D).
- the wheel is aligned perfectly straight with the axle nuts (B) well tightened
- the chain has approximately $\frac{1}{2}$ " (10 mm) slack (see page 22);
- the rear brake cable (A) is properly connected and adjusted (C).

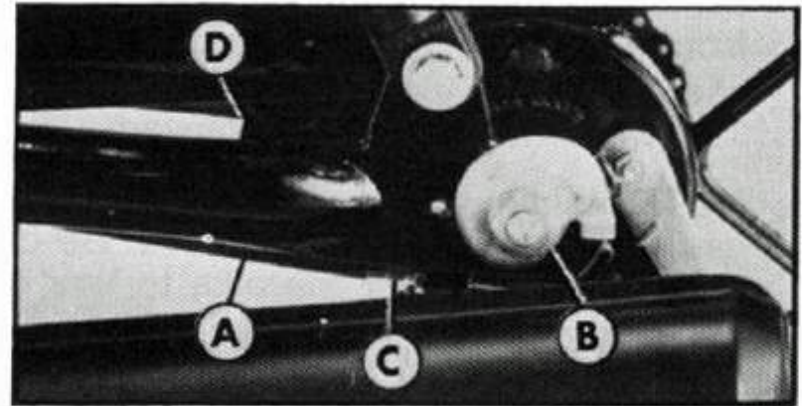

Pict. 21

Gearbox lubrication

A high quality, non-detergent SAE 30 motor oil should be used in the Garelli gearbox. The gearbox capacity is 12.0 ounces (350 cc). The oil in the gearbox should be level with the mark close to the oil filler hole located on the left engine side cover.

Warning: too much oil may cause clutch slippage and a too addicivated oil may damage the rubber body of the centrifugal clutch.

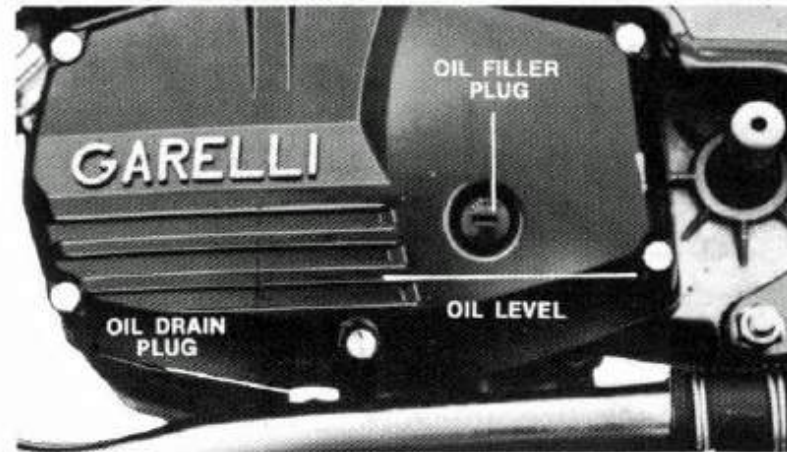

Pict. 22

The service intervals shown in the following chart are intended as a guide to establish a regular servicing routine.

	Daily before riding	After 300 mi	Every 1,000 mi	Every 2,000 mi	Every 4,000 mi	Every 6,000 mi	Page No.
1. Spark plug			CA				25
2. Clean & lubricate drive chain	C						22
3. Clean air filter				C			26
4. Check tire pressure	C						8
5. Check oil in gearbox		R	C	R			29
6. Check & tighten spokes		A		A			—
7. Check & adjust contact point gap		A	A		R		23
8. Carbon deposit on head, piston, cylinder				C			—
9. Clean carburetor & filter				C			26
10. Piston rings						R	—

	Daily before riding	After 300 mi	Every 1,000 mi	Every 2,000 mi	Every 4,000 mi	Every 6,000 mi	Page No.
11. Clutch lever		A		A			13
12. Efficiency of clutch					C		24
13. Tighten all bolts & nuts		A				A	—
14. Efficiency of brakes	C			A			14
15. Efficiency of brake shoes				C			—
16. Tighten cylinder head nuts		A				A	21
17. Muffler				C			—
18. Wheel hub bearing play					A		—
<p>C - Check A - Adjust L - Lubricate R - Replace</p>							

TROUBLE SHOOTING

A basic knowledge of mechanics is advised for use of this section, which is to assist the Garelli owner in preliminary trouble shooting only. It is suggested that you see your local authorized Garelli dealer for any problem not covered here.

Engine will not start

Fuel Flow

- check fuel flow into carburetor by removing fuel line at carburetor and turning fuel valve to both « on » and « reserve » positions;
- clean carburetor fuel filter (see page 26);
- clean carburetor main jet (see page 26).

Ignition

Remove the spark plug, refit the cap and place the spark plug on the cylinder. Turn the « run » switch on, pull the starter lever and turn the pedals. A strong blue spark should jump between the electrodes of the spark plug. If not, replace the spark plug and try the same procedure. If a blue spark is still not obtained, check the contact breaker points gap (see page 23).

Combustion Chamber Flooded

After attempting to start, remove the spark plug to check whether the electrode is wet. If it is, turn the fuel valve to the « off » position, pull the starting lever and turn the pedals by hand, leaving the spark plug out. Install a new spark plug and start the engine with the fuel valve still in the « off » position. As soon as the engine starts turn the fuel valve to « on ».

Poor engine power

If the engine starts easily, idles smoothly but loses power over a period of time:
— the exhaust system may be at fault which would require decarbonizing. If this is the problem it is suggested that you see your local Garelli dealer.

If the engine is difficult to start or runs irregularly:

- clean the spark plug electrode (replace if necessary) and set the spark plug gap (.020");
- set the contact breaker points (see page 23). If the contact points are pitted they may need replacing.

If the engine runs well but tends to «cut out» or «four stroke» at maximum speed:

- clean the carburetor air filter;
- the carburetor jet may need replacing with a slightly smaller one.

If there is excessive engine vibration:

- tighten the engine mounting bolts. There are two to the rear of the engine and one to the front (two 13 mm wrenches).

ACCELERATION AND PASSING ABILITY

This figure indicates passing times and distances that can be met or exceeded by the vehicles to which it applies, in the situations diagrammed on the next page. The low-speed pass assumes an initial speed of 20 MPH and a limiting speed of 35 MPH. The high-speed pass assumes an initial speed of 50 MPH and a limiting speed of 80 MPH.

NOTICE: The information presented represents results obtainable by skilled drivers under controlled road and vehicle conditions, and the information may not be correct under other conditions.

Description of vehicles to which this table applies: SPORT - RALLY SPORT - RALLY SPORT LTD.
SUPER SPORT - SUPER SPORT LTD. - VIP 2 SP.
MONZA G.T. 25MPH

SUMMARY TABLE

Low-speed-pass: 790 feet - 22,5 seconds
High speed-pass: NOT CAPABLE

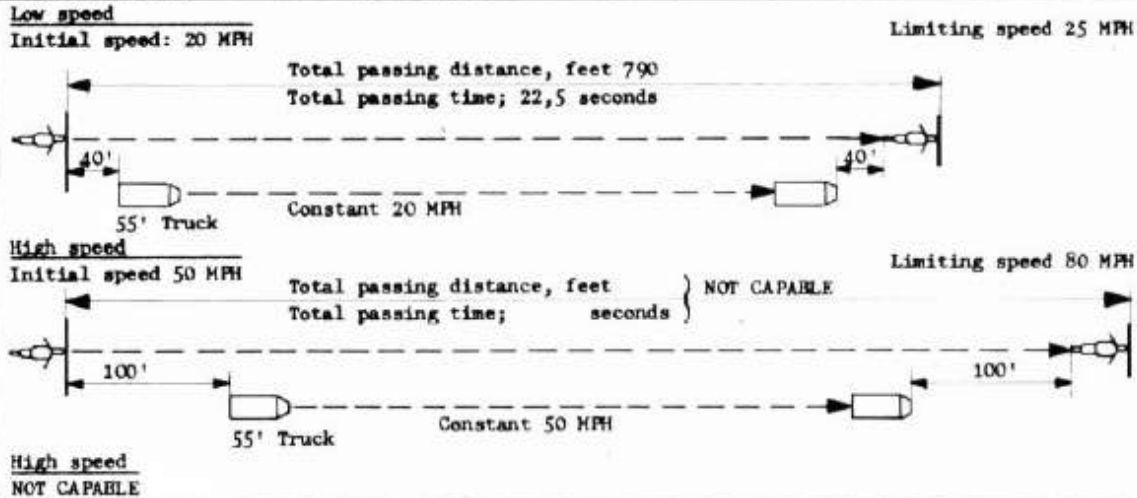

SPORT - RALLY SPORT - RALLY SPORT LTD. - SUPER SPORT - SUPER SPORT LTD. - VIP 2 SP. - MONZA G.T. 25MPH

VEHICLE STOPPING DISTANCE

This figure indicates braking performance that can be met or exceeded by the vehicles to which it applies, without locking the wheels under different conditions of loading. The information presented represents results obtainable by skilled drivers under controlled road and vehicle conditions, and the information may not be correct under other conditions.

Description of vehicles to which this table applies: SPORT - RALLY SPORT - RALLY SPORT LTD
SUPER SPORT-SUPER SPORT LTD.-VIP 2 SP.
MONZA G.T. 25MPH

Fully Operational Service Brake

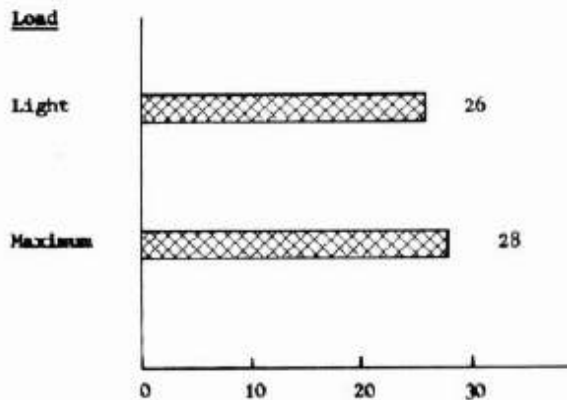

Stopping Distance in Feet from 25 MPH *

* The maximum speed attainable by accelerating at maximum rate from a standing start for one mile.

SPORT - RALLY SPORT - RALLY SPORT LTD. - SUPER SPORT - SUPER SPORT LTD. - VIP 2 SP. - MONZA G.T. 25MPH

VEHICLE STOPPING DISTANCE

This figure indicates braking performance that can be met or exceeded by the vehicles to which it applies, without locking the wheels under different conditions of loading. The information presented represents results obtainable by skilled drivers under controlled road and vehicle conditions, and the information may not be correct under other conditions.

Description of vehicles to which this table applies: SPORT-RALLY SPORT-RALLY SPORT LTD.-SUPER SPORT VIP 2 SP. - MONZA G.T. 30MPH SUPER SPORT LTD.-VIP 2 SP. - MONZA G.T. 30MPH

Fully Operational Service Brake

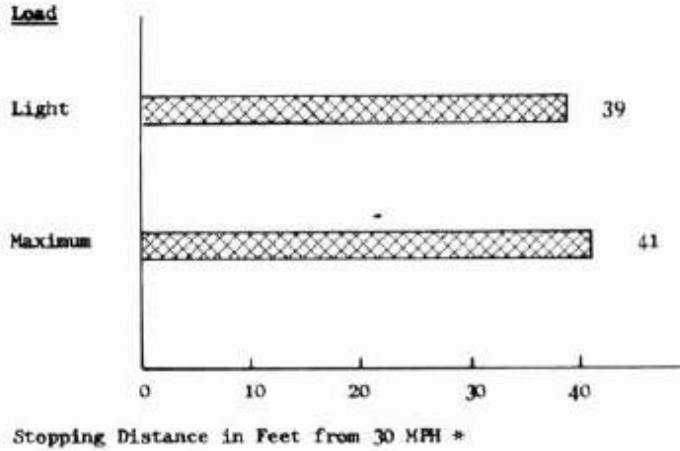

* The maximum speed attainable by accelerating at maximum rate from a standing start for one mile.

SPORT - RALLY SPORT - RALLY SPORT LTD. - SUPER SPORT - SUPER SPORT LTD. VIP 2 SP. - MONZA G.T. 30MPH

ACCELERATION AND PASSING ABILITY

This figure indicates passing times and distances that can be met or exceeded by the vehicles to which it applies, in the situations diagrammed on the next page. The low-speed pass assumes an initial speed of 20 MPH and a limiting speed of 35 MPH. The high-speed pass assumes an initial speed of 50 MPH and a limiting speed of 80 MPH.

NOTICE: The information presented represents results obtainable by skilled drivers under controlled road and vehicle conditions, and the information may not be correct under other conditions.

Description of vehicles to which this table applies: SPORT-RALLY SPORT-RALLY SPORT LTD.-SUPER SPORT SUPER SPORT LTD.-VIP 2 SP. - MONZA G.T. 30MPH

SUMMARY TABLE

Low-speed-pass: 680 feet - 18,5 seconds
 High speed-pass: NOT CAPABLE

Low speed

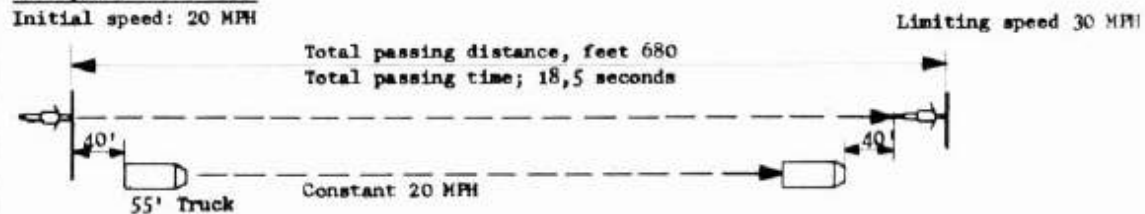

High speed

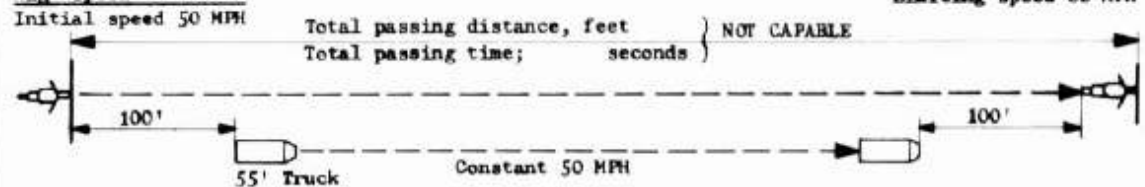

High speed
 NOT CAPABLE

SPORT - RALLY SPORT - RALLY SPORT LTD. - SUPER SPORT - SUPER SPORT LTD. VIP 2 SP. - MONZA G.T. 30MPH

PARTS & ACCESSORIES

Click on links below

[*Motorcycle Parts & Accessories*](#)

[*Dirt Bike Parts & Accessories*](#)

[*Free Shipping On Most Motorcycle Gear Orders*](#)

[*Japanese Motorcycle OEM Parts & Online Schematics*](#)

[*Save Up to 45% on Motorcycle Tires*](#)

[*Motorcycle Gear Buyer's Guide & Reviews*](#)

[*Motorcycle Gear Closeout Sale*](#)

[*High Visibility Motorcycle Safety Gear*](#)

[*Save up to 80% off on Car Parts*](#)

[*Mega Motor Madness*](#)



[*www.ClassicCycles.org*](http://www.ClassicCycles.org)