

**ZUNDAPP**

**Bella R 204**

**OPERATION AND MAINTENANCE**

### **Important:**

**Only ZUNDAPP original spare parts ensure reliability, protect against damage and keep up your guarantee. Therefore always instruct your ZUNDAPP dealer to fit only ZUNDAPP original spare parts, if you want to make sure that your machine will run without trouble and have a long life. And remember: if other than ZUNDAPP original spare parts are fitted, your guarantee becomes invalid.**

### **Foreword**

We trust that we have done everything possible to ensure the value and dependability of your BELLA for as long as possible. Years and years of experience gained in designing and building vehicles of world renown will guarantee a product that answers all the requirements from the standpoint of quality, materials, and superior workmanship. Moreover, our extensive staff of ZUNDAPP dealers will guarantee an excellent service on your BELLA.

We thank you for your confidence in our product and wish you every pleasure with our BELLA. For sheer power, smooth riding, and finger tip handling it has no equal.

ZUNDAPP-WERKE GMBH MÜNCHEN 8 - ANZINGERSTRASSE 1-3

## Contents

|  | Page |
|--|------|
| Vehicle Data . . . . .                   | 8    |
| Technical Data . . . . .                 | 9    |
| Engine . . . . .                         | 9    |
| Chassis . . . . .                        | 11   |
| Vehicle . . . . .                        | 12   |
| Fuel and Lubricants . . . . .            | 13   |
| Guaranty and Maintenance Works . . . . . | 14   |
| Your first Ride . . . . .                | 17   |
| Starting the Engine . . . . .            | 19   |
| Starting off . . . . .                   | 23   |
| Gearshifting . . . . .                   | 24   |
| On the road . . . . .                    | 25   |
| Shutting the engine off . . . . .        | 26   |

|   |    |
|---|----|
| Stopping . . . . .                                | 27 |
| Fuel Consumption . . . . .                        | 27 |
| The Engine . . . . .                              | 31 |
| Operation Method . . . . .                        | 31 |
| Cooling . . . . .                                 | 32 |
| The Power Unit . . . . .                          | 33 |
| The Carburettor . . . . .                         | 34 |
| Air Cleaner . . . . .                             | 37 |
| The Spark Plug . . . . .                          | 38 |
| The Gear Box . . . . .                            | 38 |
| The Drive . . . . .                               | 39 |
| The Starter-Generator . . . . .                   | 39 |
| The Regulator . . . . .                           | 40 |
| The Ignition Coil . . . . .                       | 40 |
| The Chassis . . . . .                             | 41 |
| The Frame . . . . .                               | 41 |
| The Front Wheel Swinging Arm Suspension . . . . . | 41 |
| The Rear Wheel Suspension . . . . .               | 42 |
| The Wheels . . . . .                              | 43 |
| The Fuel Tank . . . . .                           | 43 |

|   |    |
|---|----|
| The Batteries . . . . .   | 43 |
| The Tools . . . . .   | 44 |
| The Tyre Inflator . . . . .   | 44 |
| Regular Maintenance . . . . .   | 45 |
| The Tyres . . . . .   | 45 |
| Oil Level in the Gearbox . . . . .  | 46 |
| Servicing the Chain . . . . .   | 48 |
| Lubrication . . . . .   | 50 |
| Check all Bolts and Screws . . . . .  | 51 |
| Clutch Readjustment . . . . .   | 51 |
| Readjust Front Wheel Brake . . . . .  | 51 |
| Rear Wheel Brake Adjustment . . . . .   | 51 |
| Starter-Generator . . . . .   | 52 |
| Batteries . . . . .   | 52 |
| The Spark Plug . . . . .  | 53 |
| The Lighting System . . . . .   | 54 |
| Dismounting and Cleaning the Silencer . . . . .   | 58 |
| Special Measures for the Protection of Scooter and Two-Stroke Engine<br>during longer Periods of Inactivity . . . . . | 60 |
| Chart of Maintenance Jobs . . . . .   | 62 |

|   |    |
|---|----|
| A Number of Tips . . . . .                | 65 |
| Removing the Front Wheel . . . . .        | 65 |
| Dismounting the Rear Wheel . . . . .      | 66 |
| Hand Control Adjustment . . . . .         | 67 |
| Throttle Twist Grip Adjustment . . . . .  | 68 |
| Adjusting the Foot Change Lever . . . . . | 69 |
| Removing Rear Casing . . . . .            | 70 |

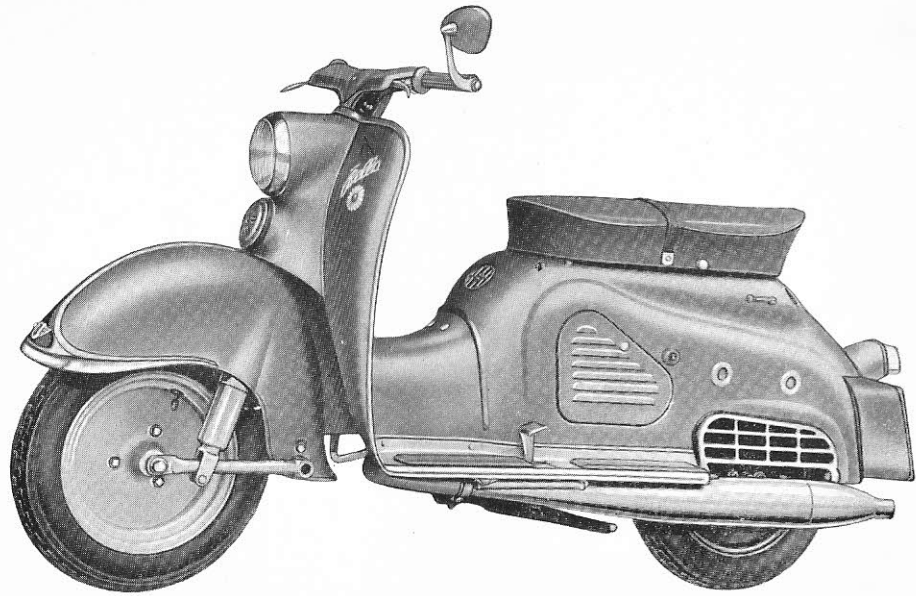

Fig. 1



Fig. 2

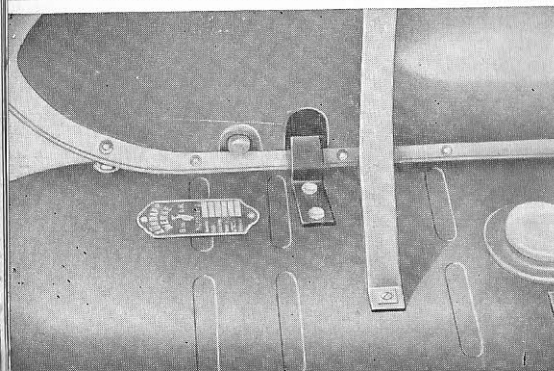
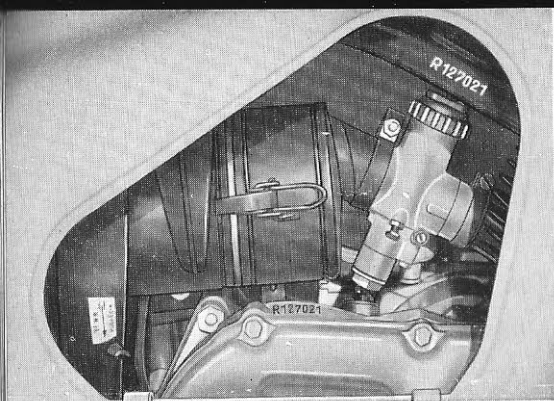

Fig. 3

### Vehicle Data

Do not forget to write your BELLA's data into the space provided below. When writing to us please give this information, and also quote the present mileage.

.....  
 Chassis No.                      Engine No.

.....  
 Name of owner

.....  
 Address of owner

.....  
 Name and address of dealer

.....  
 Date of first licensing

.....  
 Changes made on vehicle

.....

Fig. 3 a

### Technical Data

#### BELLA R 204 • 200 c.c. Model

#### Engine

|                                |   |
|--------------------------------|---|
| Type . . . . .                 | Two-stroke  |
| Number of cylinders . . . . .  | 1   |
| Stroke . . . . .               | 62 mm   |
| Bore . . . . .                 | 64 mm   |
| Capacity . . . . .             | 197 c.c. (according to tax rating)  |
| Compression ratio . . . . .    | 6.4 : 1   |
| Output . . . . .               | 12 H.P. at 5400 r.m.p.  |
| Torque . . . . .               | max. 1.9 mkg<br>at 3500-4500 r.p.m.   |
| Piston clearance . . . . .     | 0.06 mm (.002")   |
| Electrical equipment . . . . . | Starter-generator (voltage regulating)<br>type Bosch LA-ZB 12/100 L                         |
| Ignition timing . . . . .      | Ignition advance 3.0 ± 0.5 mm<br>(.118" ± .02") before t.d.c.<br>= 22.5° ± 2° before t.d.c. |

|                              |                                |           |
|------------------------------|--------------------------------|-----------|
| Spark plug . . . . .         | Bosch 240 P 11 S               | Lodge H/N |
| Electrode gap . . . . .      | 0.7 mm (.027")                 |           |
| Batteries . . . . .          | 6 volts, 11 Ah each            |           |
| Type of cooling . . . . .    | Air cooling                    |           |
| Engine lubrication . . . . . | By 1 : 25 oil/gasoline mixture |           |

Carburettor with starting device:

|  |                                   |
|--|-----------------------------------|
| Type . . . . .                               | Bing 1/24/116                     |
| Port dia. . . . .                            | 24 mm = 15/16"                    |
| Main jet . . . . .                           | 105                               |
| Needle position from top of needle . . . . . | notch 2                           |
| Needle jet . . . . .                         | 1608                              |
| Idle jet . . . . .                           | 45                                |
| Air regulator screw open . . . . .           | 1 1/2 turns                       |
| Starter jet . . . . .                        | 70                                |
| Gas slide . . . . .                          | 4                                 |
| Clutch . . . . .                             | Multiple slab running in oil bath |
| Gearbox . . . . .                            | ZÜNDAPP change-speed gear         |
| Number of speeds . . . . .                   | 4                                 |

Internal gear ratios:

|                     |           |
|---------------------|-----------|
| 1st speed . . . . . | 3.14 : 1  |
| 2nd speed . . . . . | 1.964 : 1 |
| 3rd speed . . . . . | 1.405 : 1 |
| 4th speed . . . . . | 1 : 1     |

Power transmission agent from gear-box to rear wheel . . . . .

Roller chain, enclosed  
(1/2" x 5/16", 98 links)

Gear ratio from gearbox to rear wheel . . . . .

3.0 : 1 for solo work  
3.44 : 1 for side-car work

**Chassis**

|                                 |   |
|---------------------------------|---|
| Frame . . . . .                 | Open double tube frame                                |
| Steering head bearing . . . . . | Ball bearing  |
| Front fork . . . . .            | Swinging arm suspension with hydraulic shock absorber |
| Rear wheel . . . . .            | Swinging arm suspension with hydraulic shock absorber |

Brakes:

|                      |  |
|----------------------|--|
| Foot brake . . . . . | Rod-type brake acting on rear wheel    |
| Hand brake . . . . . | Cable-type brake acting on front wheel |

Wheels:

|                     |                 |
|---------------------|-----------------|
| Rim size . . . . .  | 2.50 C x 12     |
| Tyre size . . . . . | front 3.50 - 12 |
|                     | rear 3.50 - 12  |

**Vehicle**

|                                      |                                      |
|--------------------------------------|--------------------------------------|
| Overall length . . . . .             | 1930 mm (76.04")                     |
| Width . . . . .                      | 660 mm (26.00")                      |
| Height . . . . .                     | 980 mm (38.61")                      |
| Saddle height . . . . .              | 730 mm (28.76")                      |
| Wheelbase . . . . .                  | 1320 mm (52.00")                     |
| Turning circle . . . . .             | 2900 mm (114.26")                    |
| Service weight . . . . .             | 146 kg (322 lbs) without spare wheel |
| Maximal permissible weight . . . . . | 305 kg (672 lbs) with spare wheel    |
| Top speed . . . . .                  | 90 km p. h. (55 miles p. h.)         |

**Fuel and Lubricants**

Fuel:

|                         |   |
|-------------------------|---|
| Tank capacity . . . . . | 8.5 liters (1.87 Imp.gals.=2.24 US. gals.)<br>incl. 1.7 liters (0.374 Imp.gals.<br>=0.448 US.gals.) for reserve |
|-------------------------|---|

Lubricants:

|                   |  |
|-------------------|--|
| Engine . . . . .  | quality-brand oil SAE 30 - SAE 50  |
| Gearbox . . . . . | 650 c.c. at<br>above + 15° C (+ 60° F) outside<br>temperature<br>Motor Oil SAE 40-50<br>below + 15° C (+ 60° F) outside<br>temperature<br>Motor Oil SAE 20 |

Specifications and illustrations herein are not binding, only the sales contract is decisive for the details of delivery. Changes in design and construction made under our product improvement policy do not entitle the customer to any claims against the manufacturer.



## Guaranty and Maintenance Works

The prescribed maintenance works as stated hereunder are regarded as the basis for our guaranty which covers free-of-charge replacement of parts which have become unserviceable through defects in material or workmanship. Our guaranty is valid for 6 months from first licensing date or a total mileage of 10.000 km (6000 miles).

### 1st Survey after 1000 km (600 miles)

is to be carried out 1 month after delivery,

or, at the latest, after a total mileage covered of 1200 km (720 miles)

1. Clean carburettor and fuel pipes
2. Check ignition and lighting set, adjust contact breakers, refill distilled water
3. Check and re-adjust slackness of chain and alignment, grease chain
4. Check steering
5. Check and re-adjust hand and foot brakes as well as clutch
6. Lubricate vehicle

### 2nd Survey after 2000 km (1200 miles)

is to be carried out 3 months after delivery,

or, at the latest, after a total mileage covered of 2200 km (1320 miles)

1. Clean carburettor and fuel pipes
2. Check ignition and lighting set, adjust contact breakers, refill distilled water
3. Check and re-adjust slackness of chain and alignment, grease chain
4. Check and re-adjust steering
5. Check air pressure of tyres
6. Check and re-adjust hand and foot brakes as well as clutch
7. Lubricate vehicle

### 3rd Survey after 5000 km (3000 miles)

is to be carried out 5 months after delivery,

or, at the latest, after a total mileage covered of 5500 km (3300 miles)

1. Check ignition and lighting set, adjust contact breakers, refill distilled water
2. Dismount covering body, dismount cylinder head, remove soot from head, cylinder, and bottom of piston
3. Clean exhaust set
4. Check steering
5. Retighten essential nuts and screws
6. Check and re-adjust slackness of chain and alignment, grease chain

## Your First Ride

Even if you are an experienced motor cyclist you should select a quiet area for your first trial ride, i. e. no roads with busy traffic, speedways, highways, etc.

After you have taken delivery of your BELLA from your dealer, in its showroom condition, all that remains for you to do is to fill the tank with fuel.

Your BELLA'S tank holds 8.5 liters (1.87 Imp.gal.) of petrol/oil mixture. Use a commercial grade petrol only, mixed with any well known brand of engine oil of a SAE 30 grade in a proportion of 1/3 pt. of oil to 1 gal. of petrol. When using two-stroke oil

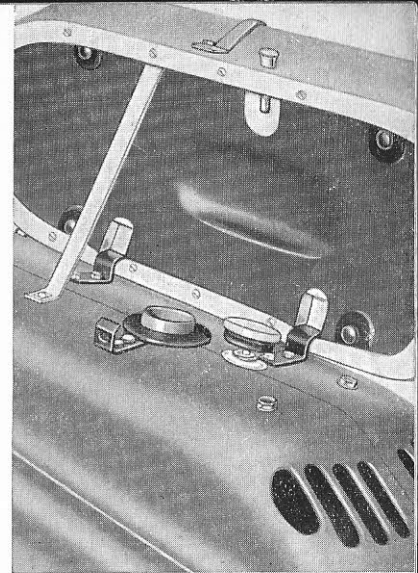

Fig. 4

use 1/2 pt. of oil to 1 gal. of petrol. Oils containing an anticorrosive or the admixture of the red ZÜNDAPP "Autol-Desolite-Rot" are recommended. Other admixtures said to increase engine performance, or to cut down gasoline consumption, are not recommended.

### Starting the engine

presents no difficulties to the experienced motorist. First, acquaint yourself with the various controls.

1. Electro Switch
2. Foot Change Lever
3. Hand Brake Control
4. Clutch Control
5. Choke Lever
6. Throttle Twist Grip
7. Dip Switch with Horn Button and Button for Pass Light
8. Foot Brake Pedal
9. Steering Damper

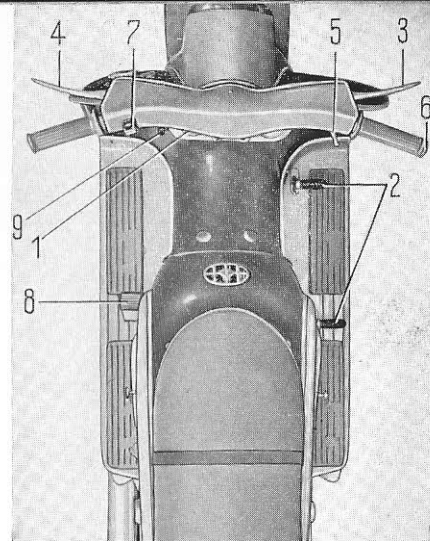

Fig. 5

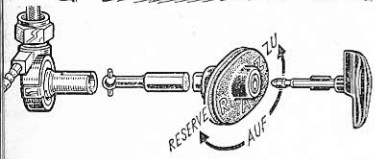
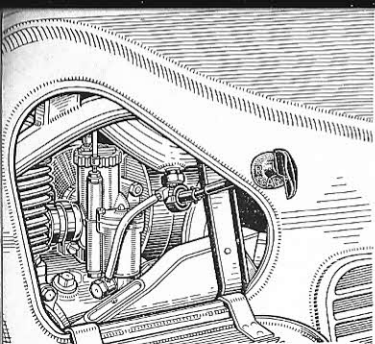

Fig. 6

If you proceed as follows normally you will never have any difficulties when starting.

Therefore:

Open the fuel tap with your ignition key

Auf = Open  
Zu = Closing  
Reserve = Reserve

Fig. 7

and pull the choke lever located on the handlebar (only with cold motor).

Now insert the ignition key into the Electro Switch until the red lamp lights up. In case the foot change control is in "neutral" position between 1st and 2nd speed, the green lamp will also light up.

**Now, light pressure on the ignition key will start the engine. (Do not actuate the starter for more than 5 seconds at one time, at intervals of approx. 10 seconds — in winter up to max. 30 seconds between each actuation!)**

Fig. 8

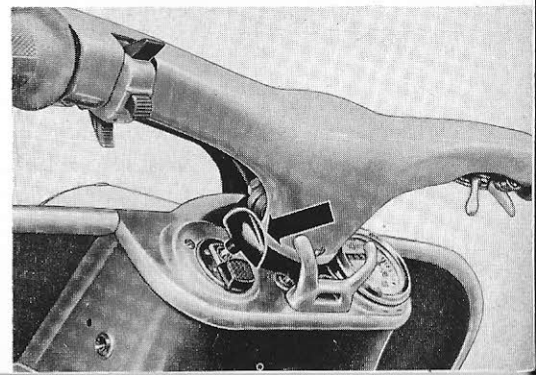
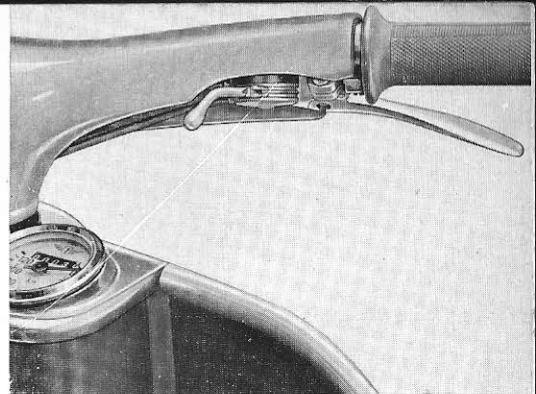

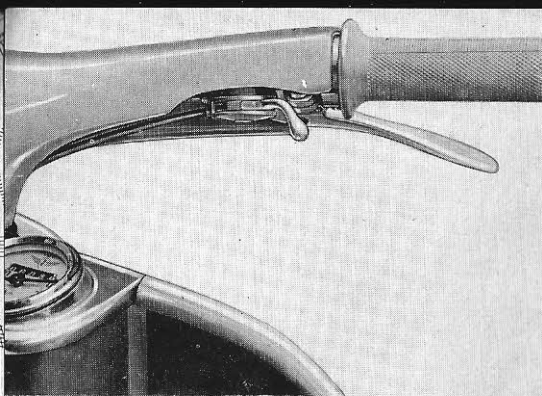

Fig. 9

Release choke lever again.

After having started the engine, do not open the throttle too much, high engine speeds while the scooter stands still will harm the engine. Do not warm up the engine while it is idling (i. e. "no load"). The engine should attain its most favourable operating temperature as quickly as possible, i. e. by taking off immediately after the engine has been started.

### Starting off

is very simple. Mount your scooter, check whether the foot change control is in "neutral" position, i. e. between 1st and 2nd speed —, pull the clutch control and

depress the front foot change lever, move in 1st speed, and release the clutch control gradually, whereby

you open the throttle gradually to the same degree as you release the clutch. Beginners tend to release the clutch too fast, or accelerate too little. In the first case the vehicle will start in leaps, in the latter case it will take off in jerks. Excessive clutch actuation will result in heavy clutch lining wear.

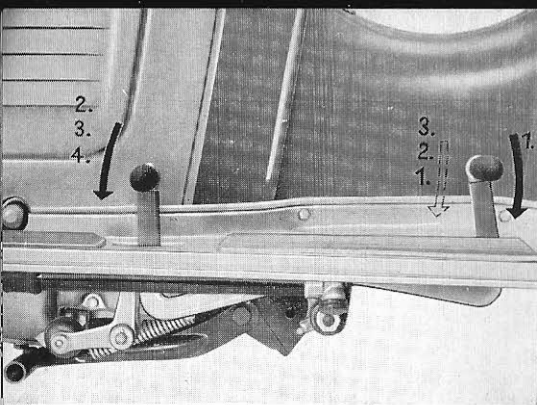

Fig. 10

### Gearshifting

After having accelerated accordingly, you can now move in the 2nd, 3rd and 4th (or "high") speeds, the so-called "changing-up". On level roads, if possible, try to avoid changing from

- 1st to 2nd speed under 20 km.p.h.  
(approx. 12 m.p.h.)
- 2nd to 3rd speed under 40 km.p.h.  
(approx. 25 m.p.h.)
- 3rd to 4th speed under 60 km.p.h.  
(approx. 37 m.p.h.)

See the red markings on the speedometer face.

When changing "up", close the throttle swiftly, declutch, depress the rear foot change lever until the stop, thereby moving into the next higher speed, release clutch, and accelerate.

When changing "down", close the throttle swiftly, and change to "neutral" position (the central position between all of the other speeds) by just touching the front foot change lever (do not depress until the stop!)

During idling, accelerate according to your speed (at high speed accelerate much, at low speed little), move into the next lower gear by declutching and depressing the front change lever until the stop, and release clutch.

### On the road

During the first 500 km (= 300 miles) the engine should not be driven at full load, i.e. don't drive it with the throttle fully open all the time. From then on up to 1000 km (= 600 miles) you can ride it with ever increasing loads. From 1000 km (= 600 miles) on you can use your BELLA to its full capacity. There are no speed limits to be observed during the first 600 miles, yet we do not recommend riding the scooter full speed for very long periods of time. Important: **Never keep the engine speed too low**, for

a cold engine means excessive wear (reduced lubrication qualities of the fuel-oil mixture as well as increased danger of corrosion) and increases the formation of carbon deposits, thus impairing your vehicle's efficiency and shortening its service life.

When climbing **grades**, change "down" early enough and employ a higher engine speed. Go **downhill** using the same speed you would use for climbing the same grade! Always accelerate enough in order to provide sufficient lubrication. Near **dangerous curves and corners** with little or no vision reduce speed so as to keep BELLA under control, and, if necessary, change down. On wet and slippery roads use your brakes with extra care in order to avoid skidding.

#### **Shutting the Engine off**

If the vehicle is intended to be left idle for a short period of time, just close the throttle twist grip, remove the ignition key, and close the fuel tap. For very long idle periods, or after the engine has been under considerable strain, proceed as follows:

1. Rev up engine and
2. pull momentarily on the choke lever
3. remove the ignition key
4. close the twist grip and
5. the fuel tap.

This method provides for the engine additional "internal cooling"; furthermore, all important engine parts are covered with an oil film that affords added protection against corrosion.

With engine shut off, **always** remove the ignition key in order to prevent the battery from getting discharged. In case breaker contacts should accidentally be closed it might also endanger the ignition coil.

#### **Stopping**

In emergency cases closing the throttle, simultaneously applying both brakes and declutching shortly before coming to the stop. Normally the driver, in such cases, will then change to "neutral", preferably between 1st and 2nd speeds so that he can change to 1st speed again without loss of time.

For stopping, always move over to the side of the road! Do not apply the brakes too abruptly; skidding wheels mean excessive tyre wear and retarded braking effect.

#### **Fuel Consumption**

If it should be necessary to change the adjustment of the carburettor as determined by our works after a long period of experiments, we would advise you to do that with special caution and prudence. For, as you know, the two-stroke engine is not only cooled by the blast of air that results from the vehicle's movement, but also the fuel-air mixture taken in by the carburettor contributes towards a suitable working temperature. If this so-called "internal cooling" will be reduced by using

smaller jets of carburettor or by changing the needle position, there is the risk that the engine will get overheated resulting in pinking, pre-ignition etc. or even piston seizure.

Fuel consumption will inevitably increase if you

drive in low gears

change speeds frequently

(driving in the city or in mountainous areas)

drive against the wind.

L/100 km (60 ms.)

Fig. 11

Bella 200 ccm with side care

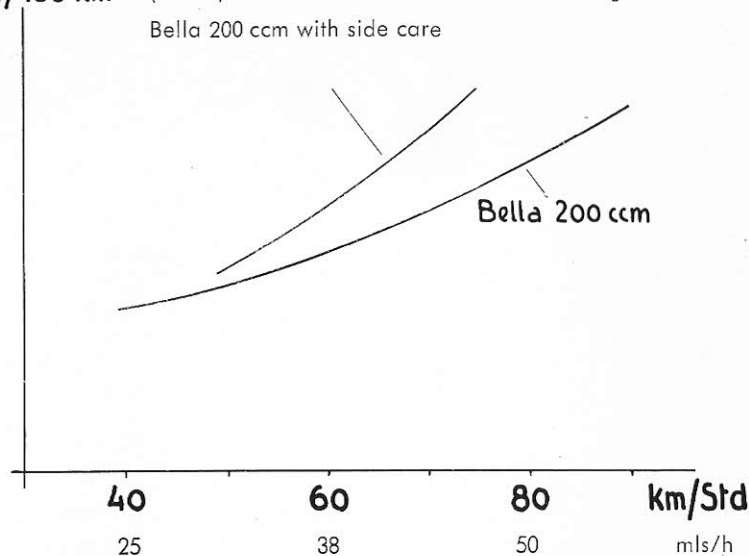

The subdivision of the vertical line in liters per 100 km was left out as, for the reasons specified, the fuel consumption will present a different picture in each individual case.



The following reasons may be responsible for high fuel consumption too (**avoidable**):

- letting the engine run in "neutral"
- accelerating too abruptly
- driving in low gears too long
- incorrect carburettor adjustment and ignition timing
- carbon deposits in engine or excessive piston clearance
- clutch slippage
- additional load
- mounting a windshield or
- a large trunk or suitcase across the luggage carrier
- insufficient tyre pressure.

You will notice that, after having attained a certain speed, you can turn the twist grip back a considerable degree without losing speed. Doing this every time will also keep fuel consumption low.

## **The Engine**

### **Operation Method**

The ZÜNDAPP two-stroke engine works on the tested and proven reverse scavenging principle. The fuel-air mixture taken in from carburettor by the upward stroke of the piston is compressed inside the crankcase during the downward stroke, passes subsequently into the compression chamber, through two ducts, is compressed and burned during the following upward stroke. The burned gases, after the downward stroke (power stroke), are forced out into the open air through the exhaust port, the exhaust pipe, and the silencer.

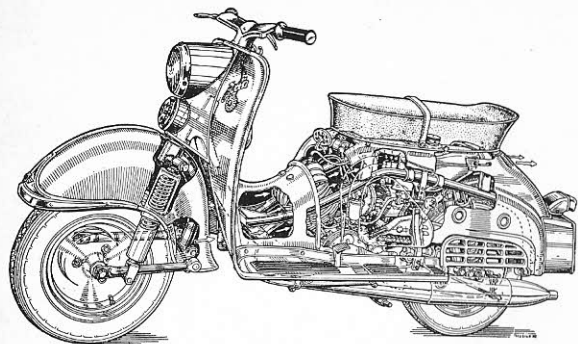

Fig 12

### Cooling

The engine is cooled by the steady blast of air that results from the vehicle's movement and is led to the engine by means of an air tunnel. The fuel-air mixture taken in by the carburettor also contributes towards a suitable working temperature in all speed ranges ("internal cooling"). While the engine idles the so-called "thermic air blast" guarantees sufficient heat removal: The air

that heats up at the cylinder and head rises because of its lesser weight, escapes through the louvers under the dual seat and causes a stream of fresh cool air to enter from below.

By fitting unsuitable pannier frames the current of air will be hindered which may result in engine trouble. Will you, therefore, take this matter into consideration when obtaining pannier frames.

### The Power Unit

The pressure caused by expanding gases is transmitted to the crankshaft over piston, gudgeon pin and connecting rod, and subsequently converted into torque (torsional force). The flywheel provides uniform rotary movement.

1. Piston
2. Connecting rod
3. Crankshaft
4. Flywheel
5. Chain
6. Clutch
7. 1st speed gear pair
8. 2nd speed gear pair
9. 3rd speed gear pair
10. 4th speed gear pair
11. Front sprocket
12. Chain
13. Rear sprocket

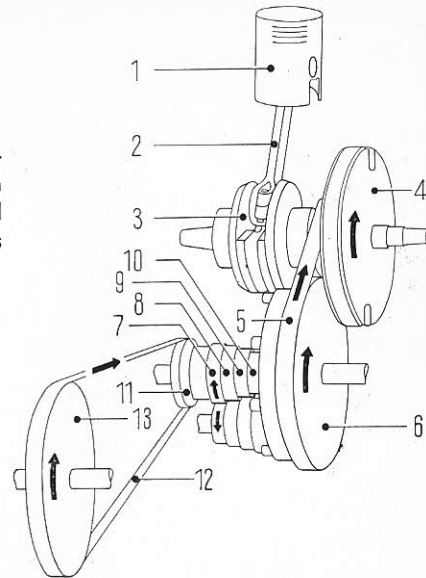

Fig. 13

A suitably designed gear ration between crankshaft and clutch results in a reduction of the engine speed (increase of rotary power). Actuating the clutch means an interruption in the transmitting of power to the change speed gear. Inside the gearset a further conversion of speed and rotary force is effected by selecting different speeds.

From the gearset the power is transmitted further into the drive sprocket arranged outside of the engine block, and from there to the rear sprocket over the chain.

### The Carburettor

together with the air cleaner provides for a suitable fuel-air mixture, i.e. converts the liquid fuel into a mixture for subsequent combustion.

The carburettor consists of two parts:

- the float chamber and
- the carburettor housing.

The float chamber contains the float which is connected with the float needle by means of a clamping spring. The float automatically maintains a uniform fuel level in the carburettor. When the fuel tap is opened, fuel flows into the float

chamber thereby lifting the float together with the float needle. The float needle, on its lower end, is tapered, and, when the correct fuel level has been attained, interrupts the flow of fuel from the fuel line. Actuation of the choke lever causes an additional jet system to start operating which immediately provides the engine with an explosive fuel-air mixture. The carburettor's task is to deliver a correctly proportioned fuel-air mixture for all speed ranges.

For this purpose a number of jet systems are necessary, i.e.

the idle jet system,

consisting of idle jet K and idle air adjusting screw K<sub>1</sub>.

During idling this is the only system that operates; with increasing speed, however it operates decreasingly in conjunction with the other jet systems. With increasing speed, the

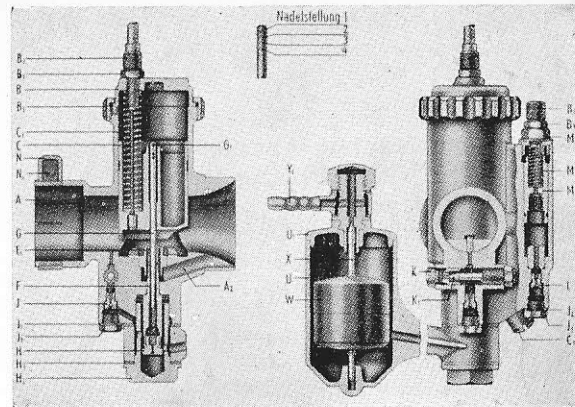

Fig. 14

mixing chamber insert (sprayer) E<sub>1</sub>, together with jet needle G and needle valve F start operating, then needle G and needle valve F alone. Only after considerable speed has been attained, the main jet H starts to function.

Jet sizes as well as carburettor adjustment were determined by extensive research work and years of experience. This means that, after the carburettor has been cleaned, all that remains to do is to adjust the idle system and the cables.

#### 1. Idle adjustment

Keep engine idling. Screw in gas slide stop screw C<sub>3</sub> until the engine runs with twist grip closed; screw in idle air adjusting screw K<sub>1</sub> completely, and screw it out again until engine attains its highest speed possible. Then give the screw another 90° turn inward. Now screw out gas slide stop screw C<sub>3</sub> until the engine runs with the desired idle speed.

#### 2. The Bowden cables

The Bowden cable adjusting screws must be adjusted in such a way that, when the slide is closed, a play of abt. 1 mm (.04") is provided for between the Bowden cable sheathing and the adjusting screw.

It is advisable not to alter the carburettor adjustment which has been determined by us after a long period of experimenting. In case of need, alterations should only be made by experts. A too lean adjustment may cause damages resulting

in costly repairs. Would like to stress that we shall decline any claim under guaranty in such cases.

#### Air Cleaner

The air cleaner has been designed to separate all foreign matter from the air necessary for combustion. In order to achieve a better cleaning effect the metal gauze inside the air cleaner has been treated with oil. High cleaning effect means a minimum of wear on the drive mechanism. — Therefore: **Service Air Cleaner regularly and treat it with oil!**

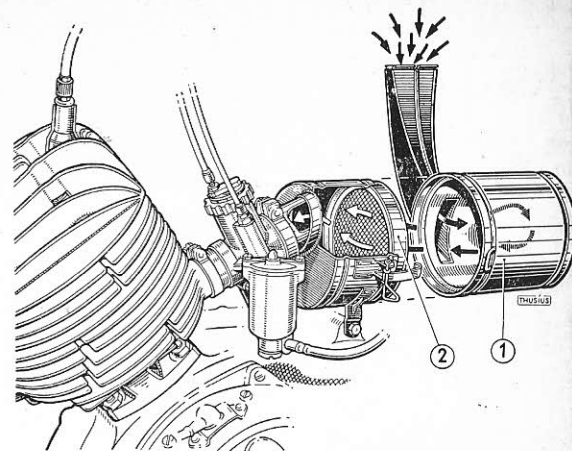
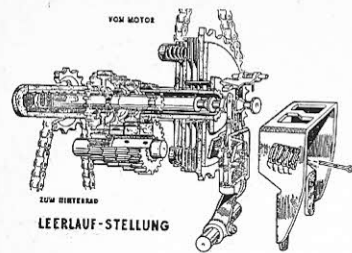

Fig. 15



- vom Motor = from engine  
 zum Hinterrad = to rear wheel  
 Leerlauf-Stellung = neutral position  
 1. Gang = 1st speed  
 4. Gang = 4th speed

### The Spark Plug

is screwed into the cylinder head with a 14x1.5 mm thread. The following spark plugs are recommended

Bosch W 240 P 11 S  
 Lodge HN

or any other make of equal quality.

### The Gear Box

consists of 4 pairs of gears. While the sliding gears run loosely on the transmission shaft, their opposing gears form a so-called gear cluster. This gear cluster runs on the countershaft. Shifting gears is done by moving the splined transmission shaft laterally within the sliding gears

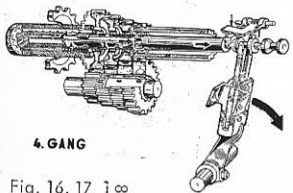
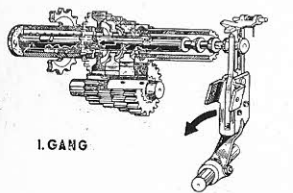

Fig. 16, 17, 18

which have interior gearing. The gearset is said to be in "neutral" when none of the sliding gears is in mesh with any of the driving gears (that is the case when the transmission shaft is in one of the spaces between the sliding gears). From the transmission shaft the power is transmitted to the small chain sprocket located on the outside of the engine.

### The Drive

is accomplished by means of the small chain sprocket, the secondary chain (1/2" x 5/16", 98 links for solo and 102 links for side-car work) and the rear sprocket to the rear wheel. For solo work the rear sprocket has 48 teeth and for side-car work 55 teeth.

### The Starter-Generator

is a D. C. machine operating as a series-wound motor for a starter and as a shunt-wound generator for battery recharging. The armature of the current-regulating generator slides on the engine crankshaft. The generator housing is flanged to the crankcase of the engine. The primary current breaker for the ignition has been arranged at the armature end. The contact breaker cam is automatically governed by a flyball governor so that the spark is always properly timed under varying loads and speeds of the engine (low speed = retard; high speed = advance).

### **The Regulator**

is located in a special casing, between the batteries, separately from the engine.

### **The Ignition Coil**

is mounted on the frame, separately from the engine.

## **The Chassis**

### **The Frame**

The so-called open double-tube frame is made of special material. The rigid connection between grid flaps, running board, and running board support provides added rigidity for the chassis. Therefore the lateral grid flaps must be screwed in place each time they are flapped down.

### **The Front Wheel Swinging Arm Suspension**

The vehicle suspension has been designed as to fully absorb all shocks, bumps and potholes in the road.

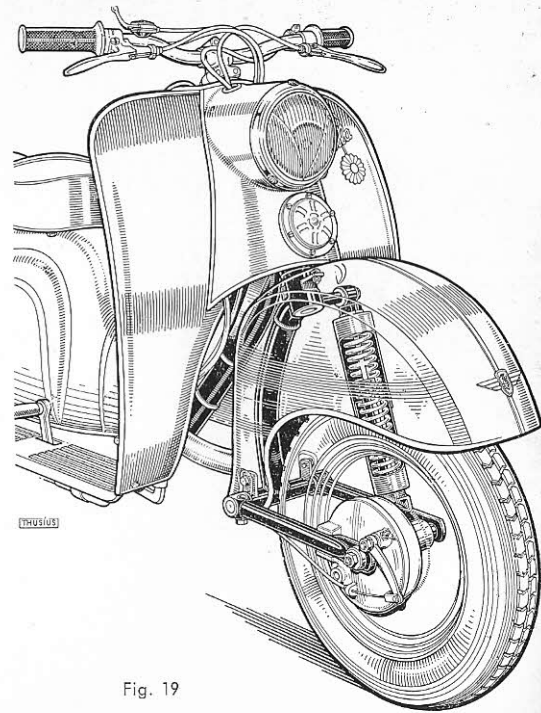

Fig. 19

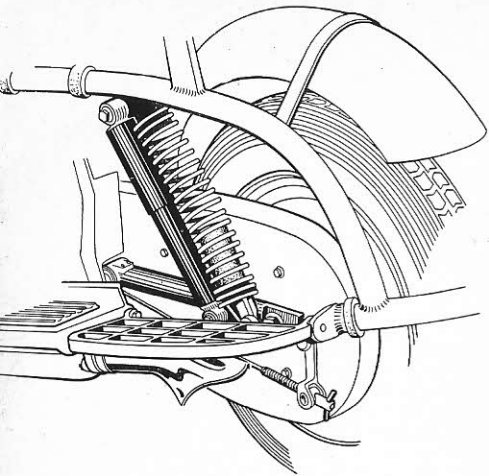

Fig. 20

### The Rear Wheel Suspension

is also a swinging arm suspension. The rear fork with the wheel swings around a fulcrum in the frame. Bumps from rough roads are cushioned by means of a spring on each side and one hydraulic shock absorber.

For this purpose, the swinging arm suspension type has shown best success according to latest experiences. The construction and action of the front fork may be seen from the illustration. It also shows the spring within the spring unit (so-called "spring leg") and the hydraulic shock absorber within the spring. These parts do not require any maintenance.

### The Wheels

have rims 2.50 x 12. The tyres are steel wire reinforced low pressure tyres of size 3.50-12 for both wheels. The brake drums of 150 mm diameter are of cast grey iron.

### The Fuel Tank

holds 8.5 liters (1.87 Imp. gals. = 2.24 US. gals.) and rests on rubber mounts. 1.7 liters (0.374 Imp. gals. = 0.488 US. gals.) of reserve.

### The Batteries

have a capacity of 11 ampere-hours. They are mounted vibration-free under a shielding at the dashboard.

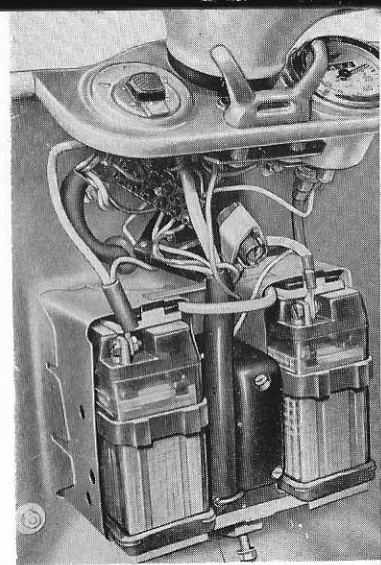

Fig. 21



### The Tools

are contained in a case located at the end of the vehicle. The bracket for the number plate serves simultaneously as case cover, being secured by two screws at the sides.

### The Tyre Inflator

is fixed under the right-hand running board.

## Regular Maintenance

will prolong the service life of your BELLA and contribute to retaining its value and dependability for many years to come.

### The Tyres

Check them periodically for correct inflation:

|             | solo                 | with passenger       | with side-car         |
|-------------|----------------------|----------------------|-----------------------|
| rear wheel  | 1.5 atm. (21 p.s.i.) | 1.9 atm. (27 p.s.i.) | 2.25 atm. (32 p.s.i.) |
| front wheel | 1.2 atm. (17 p.s.i.) | 1.2 atm. (17 p.s.i.) | 1.4 atm. (20 p.s.i.)  |

Incorrect tyre pressure will cause

bad roadholding  
uneven wear on tyres  
brittleness etc.

It is recommended to interchange the tyres about every 5000 kilometers (3000 miles). Repaired tyres should always be mounted on the rear wheel. Grease, oil, and excessive heat are definitely damaging the rubber. Store your tyres in a cool, humid place.

Fig. 22



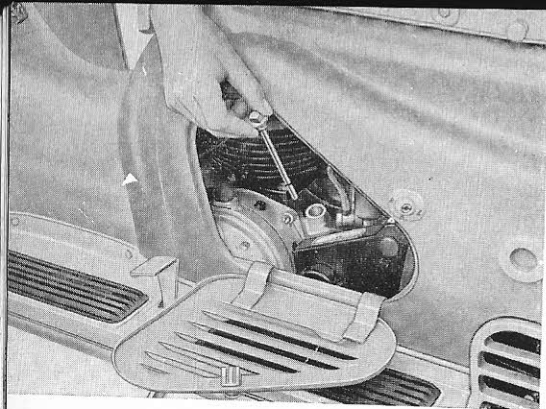

Fig. 23

### Oil Level in the Gearbox

Check oil level in the gearbox regularly and add oil if necessary. For measuring, **do not screw in the oil level measuring stick**, just insert it. The oil level should register at the "Full" mark.

Normally the oil should be changed every 10.000 km (6000 miles). For this purpose remove the two oil drain plugs. The correct amount of oil is 650 c.c. The type of oil should be adapted to prevailing climatic conditions.

We recommend  
in warm weather  
in cold weather

SAE 40-50  
SAE 20

After new oil has been supplied don't forget that some time will pass before the oil is distributed all over gearbox and crankcase, i. e. the oil measuring stick will show a correct oil level only after you have driven the scooter for a short distance. Illustration 24 shows where the two drain plugs are situated.

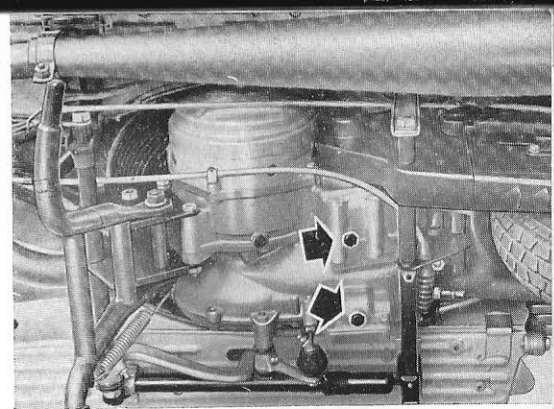

Fig. 24

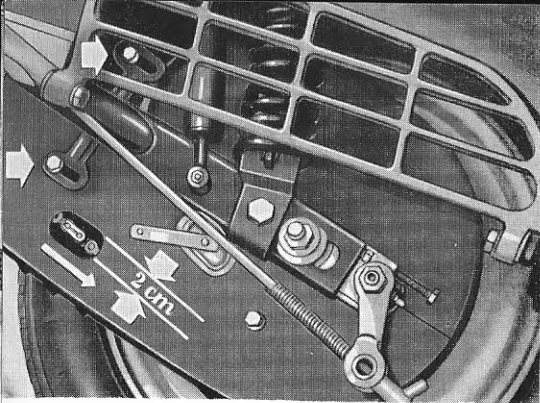

Fig. 25

### Servicing the Chain

is extremely important! Unlike the rigidframe motor cycle with large-diameter wheels and moderate speed, the modern vehicle exerts much more strain on the chain because of the pivot arm movement, and definitely higher chain speeds. Thus not only correct wheel alignment and chain slackness should be checked, but also our instructions for correct lubrication followed closely. Chain slackness should be 2 cm (0.79") when one person rides the vehicle. Correct alignment

can be checked by means of a long stick laid against the tyres. For chain readjustment, loosen front chain guard support and axle nut. Then adjust the two chain tighteners uniformly. When correct chain adjustment has been obtained, retighten lock nut, chain guard support, and axle nut.

Grease the chain regularly every 500 km (300 miles). Only use special chain grease which has superior lubricating properties and adhesive power even under high temperatures.

After max. 5000 km (3200 miles) remove the chain and wash it with drycleaning gasoline or kerosene and dry it with sawdust. Lay it in heated chain grease until the grease has entered between links, pins, and rollers. Before putting the greased chain on, do not forget to clean the sprockets. When renewing the chain, the sprockets should always be exchanged, for worn sprockets will ruin any new chain within shortest time.

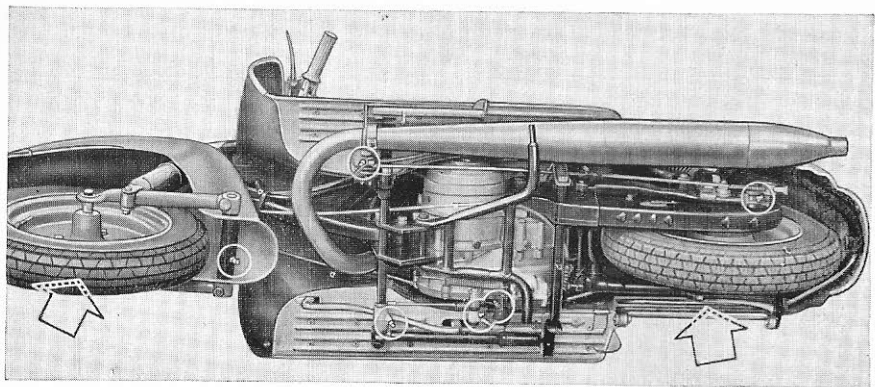

Fig. 26

### Lubrication

The vehicle has 8 lubrication points which should be greased every 1000 km (600 miles) by means of a grease gun. Before greasing, clean all grease cups thoroughly.

### Check all Bolts and Screws

for tightness each time you perform the above mentioned grease job.

### Clutch Readjustment

Check for approx. 1 mm (.04") of play at the clutch control. Otherwise there is danger of clutch slippage. Readjustment is made on the handlebar by means of knurled screw and lock nut.

### Readjust Front Wheel Brake

Readjustment is made on the handlebar by means of knurled screw and lock nut. Do not adjust too tightly, as otherwise the brake linings will seize while you drive.

### Rear Wheel Brake Adjustment

Adjust by turning the wing nut accordingly. Do not adjust too tightly.

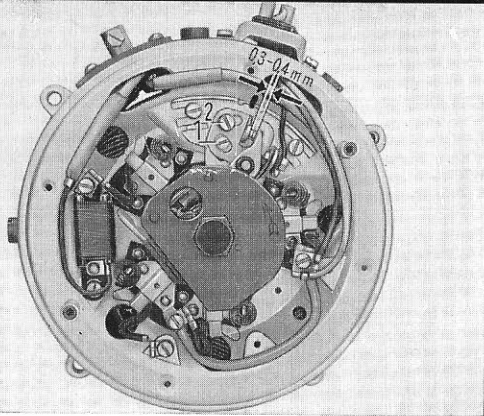

Fig. 27

### Starter-Generator

Check for correct gap between breaker contacts every 5000 km (3000 miles). For readjustment, loosen set screw 2) and turn excentric screw 1) in such a way as to obtain a gap of 0.3–0.4 mm (.012–.016") (1 mm = .04" of contact gap corresponds with 10° ignition timing).

Also the grease felt should be provided with a sufficient amount of grease every 5000 km (3000 miles). All other generator parts require no maintenance.

### Batteries

Check acid level every 1000 km (600 miles). In case the level does not register at the mark, add distilled water (never acid!). – In case the vehicle is to be parked for a longer period of time the batteries should be taken out and serviced by a competent workshop every month.

During wintertime the batteries should be serviced with special care. A discharged battery will freeze at + 17.6° F (–8° C.), insufficiently charged batteries at a correspondingly lower temperature.

### The Spark Plug

Check for correct gap of 0.7 mm (.027") between electrodes. By observing the so-called "face of the plug" you can control your driving technique and obtain a correct picture of the state your engine is in.

- Sooty plug: Carburettor adjusted for too rich mixture, or engine is not warmed up sufficiently.
- Burned plug: Carburettor adjusted for too lean mixture or carbon deposits in engine.

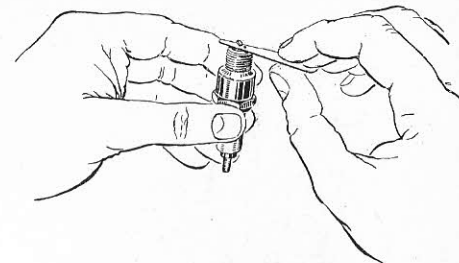

Fig. 28

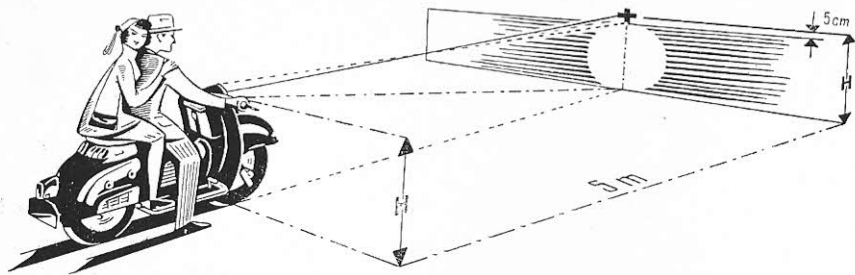

Fig. 29

### The Lighting System

Your scooter's lighting system must at all times comply with police regulations. Defective bulbs or cables must be replaced immediately. To adjust the headlight, place your BELLA with two persons on the machine on level ground and adjust the scooter's axis to  $90^\circ$  in relation to a wall, at 5 m (15 ft.) distance from said wall. Mark height "H" of the headlight center by means of a cross.

### High Beam Adjustment:

Switch headlight on. The center of the light circle appearing on the wall must correspond with cross "H".

### Dipped Beam Adjustment:

The border between light and dark area that you see on the wall (upper border) must at least be 5 cm (2") below cross "H", and should run in horizontal direction. If not, readjust headlight accordingly. For headlight readjustment, the chromium plated head light rim has been provided with 3 elongated holes. Loosen screws and adjust headlight reflector to correct position. Then retighten screws.

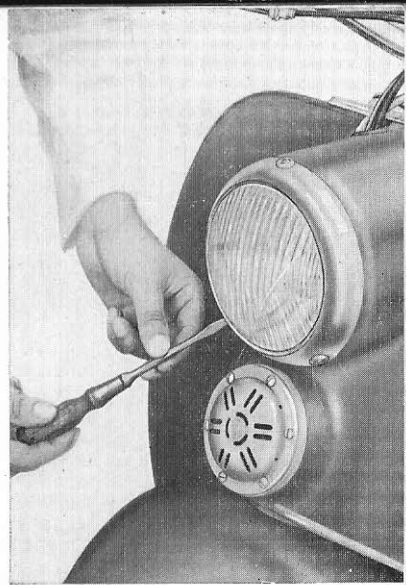
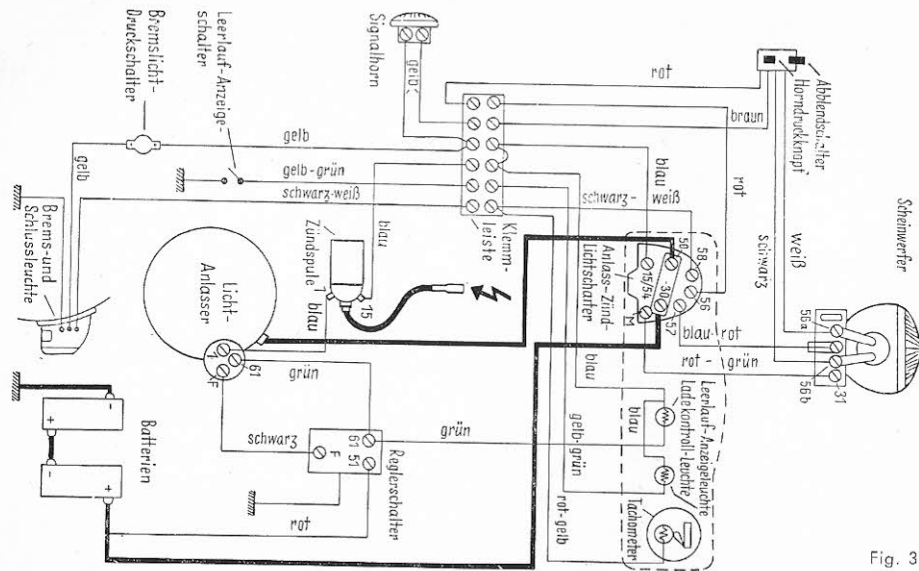

Fig. 30



Wiring Diagram for Electrical Equipment

Fig. 31

- |                          |                                 |                          |                               |
|--------------------------|---------------------------------|--------------------------|-------------------------------|
| Scheinwerfer             | = Headlight                     | Licht-Anlasser           | = Starter-Generator           |
| Abblendschalter          | = Dip Switch                    | Bremslicht-Druckschalter | = Brake-Light-Pressure-Switch |
| Leuchthupe               | = Headlight Signal              | Batterien                | = Batteries                   |
| Horndruckknopf           | = Horn Button                   | Brems- und Schlußleuchte | = Brake and Taillight         |
| Leerlauf-Anzeigelampe    | = Idle Check Light              | weiß                     | = white                       |
| Ladekontroll-Leuchte     | = Charge Control Light          | schwarz                  | = black                       |
| Tachometer               | = Speedometer                   | blau                     | = blue                        |
| Anlaß-Zünd-Lichtschalter | = Starter-Ignition-Light-Switch | rot                      | = red                         |
| Klemmleiste              | = Terminal Plate                | grün                     | = green                       |
| Signalhorn               | = Horn                          | gelb                     | = yellow                      |
| Zündspule                | = Ignition Coil                 |                          |                               |
| Reglerschalter           | = Regulator                     |                          |                               |
| Leerlauf-Anzeigeschalter | = Idle Switch                   |                          |                               |

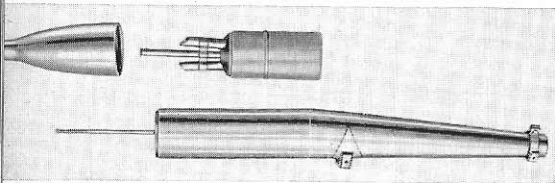
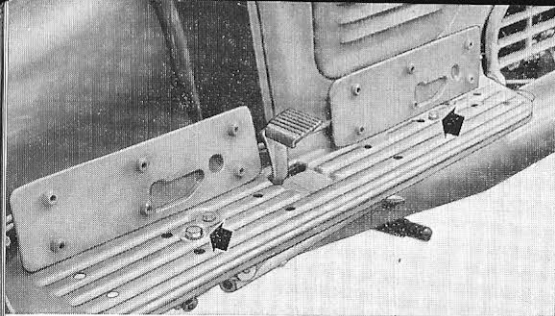

Fig. 32 and 33

### Dismounting and Cleaning the Silencer

For a good functioning of the engine, the proper state of the exhaust set is of utmost importance.

Depending on driving technique, engine adjustment, or type of fuel-oil mixture used, it will be necessary to clean the silencer between every 2000 and 10000 km (1200 and 6000 miles).

For detaching the muffler, loosen the front clip and the two clamping screws under the rubber mats. After the nut located at the silencer end has been removed, the muffler can be dismantled into its three structural parts.

When reassembling, make sure to replace the asbestos packing between both main parts of the silencer.

A clogged or battered silencer will restrict free passage of burned gases, reduce the engine performance, and may cause the engine to get overheated, thus producing "pinking" and pre-ignition.

Therefore:

**Clean regularly!**

**Special Measures for the Protection of Scooter and Two-Stroke Engine during longer Periods of Inactivity:**

The maintenance works specified below will prevent corrosion in motor and chassis and your BELLA will be ready for action as soon as you need it. We recommend the following sequence:

1. Warm up the engine thoroughly by riding 15–25 km (10–15 miles).
2. Remove carburettor. While the starter is actuated without ignition (take out plug cap) have the engine take in 50 c.c. of anti-corrosion oil through the intake manifold.
3. Clean carburettor, air cleaner and fuel line, and reassemble. The throttle twist grip is kept closed.
4. Change the oil in the gearbox.
5. Remove drive chain. In order to be able to put it on again without difficulty just attach a piece of old chain onto it and leave the latter on the drive sprocket. Later on connect the new chain to abovementioned chain section and pull the new chain through. The chain is cleaned and greased as specified in the operation manual.

6. Take out batteries, deposit them in a dry place away from the frost, and have them checked every 4–6 weeks by a workshop (Do not empty batteries!).
7. Oily engine and chassis parts should be cleaned by means of kerosene and a brush.
8. Use a suitable detergent (Many of them are on the market. Observe instructions for use!) for washing chassis and engine, do not spray with a hose. Dry with sponge and chamois leather.
9. Remove generator cover and dry completely. Likewise, rub generator interior dry.
10. Rub all chromium parts with acid-resistant vaseline.
11. Spray the whole vehicle with an atomizer.  
(Suitable spray oils are on the market.)
12. Lubricate all lubricating points according to diagram.
13. Prop up vehicle on a prop stand in a dry room so that the tyres do not touch ground.
14. Deflate tyres until they show 1 atm. (14 p.s.i.) pressure.
15. Cover the vehicle up in order to protect it against dust.



### Chart of Maintenance Jobs

| After miles (km)   | Type of maintenance work                     | Remarks                  | Details page                           |    |
|--------------------|--|--------------------------|--|----|
| 300<br>(500)       | Small chain servicing                        | Special chain grease     | 48                                     |    |
| 600<br>(1000)      | Retighten bolts and nuts                     | Mobilcompound No. 4      | 51                                     |    |
|                    | Grease vehicle                               |                          | 50                                     |    |
|                    | Lubricate fulcrums in hand and foot controls | A few drops of motor oil | —                                      |    |
| 3000<br>(5000)     | Full chain servicing job                     | Special chain grease     | 52                                     |    |
|                    |  |                          | Clean air cleaner and replace oil film | 37 |
|                    |  |                          | Check breaker contact gap              | 52 |
|                    |  |                          | Clean spark plug and check gap         | 53 |
| 6000<br>(10 000)   | Oil change in gearbox                        | Mobiloil SAE 20-50       | 46                                     |    |
| 12 000<br>(20 000) | Fill wheel hubs with grease                  | Mobilcompound No. 4      | —                                      |    |

You can do all of these maintenance jobs yourself. The following jobs, however, you should have done by the ZUNDAPP dealer's workshop with its trained staff:

- All jobs on the engine
- Repairs on the Braking system
  - Front fork
  - Frame and swinging arm suspension
- Removal of carbon deposits
- Repair work after accidents.

However, for repair works on the generator, BOSCH dealers are competent.

## Removing the Front Wheel

you can do yourself! The simplest and fastest way is as follows:

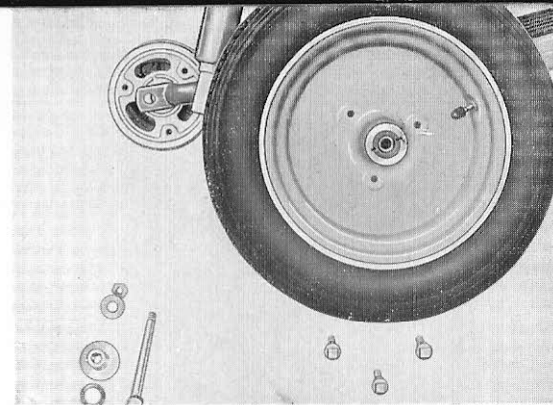

Fig. 34

## Removing the Front Wheel

1. Prop vehicle on its central stand
  2. Take off the 3 square screws
  3. Loosen spindle nut and
  4. Push hub spindle through. Make sure you don't lose the bushing, tilt vehicle to the side, and take off the wheel.
- Refitting is done in reversed order.

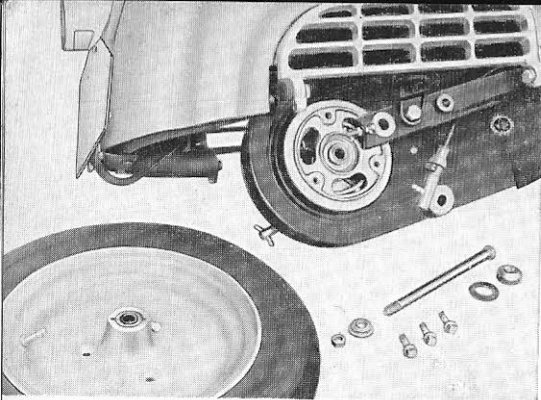

Fig. 35

### Dismounting the Rear Wheel

1. Remove the 3 wheel screws (right-hand thread)
2. Loosen spindle nut and detach retaining ring
3. Lay vehicle on left-hand running board
4. Pull out spindle. Don't lose bushing.
5. Take off speedometer drive.
6. Take off the wheel.

Remounting is done in reversed sequence. Make sure the bushing is replaced correctly and the speedometer drive cable is not twisted. The two pins arranged at the speedometer drive must engage with the two holes provided at the hub end.

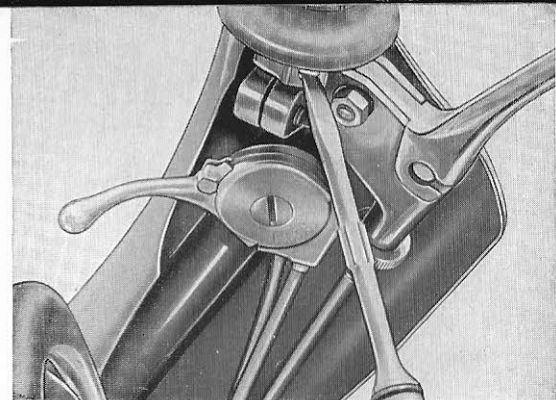

Fig. 36

### Hand Control Adjustment

The position of the hand controls (clutch and hand brake control) can be adjusted to your special requirement. Just loosen the set screw, turn the lever to the desired position, and retighten the screw.

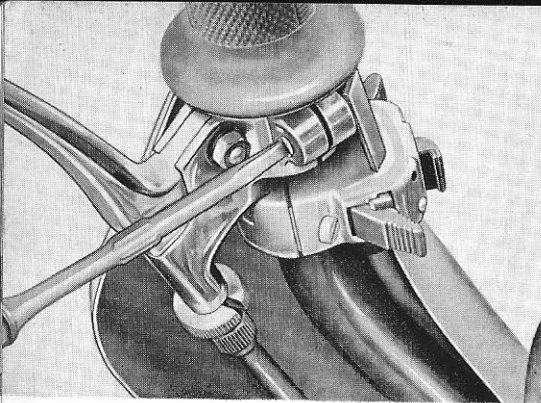

Fig. 37

### Throttle Twist Grip Adjustment

Loosening or tightening the small screw provided at the twist grip regulates the pressure of a leaf spring which makes it either harder, or easier for you to turn the twist grip.

### Adjusting the Foot Change Lever

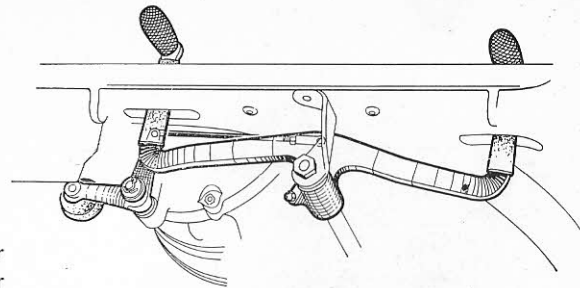

Fig. 38

The position of the foot change lever can be altered by shortening or lengthening the connection between foot change lever and the bell crank, if the lever touches the running board during the gearshifting process so that the different speeds cannot be selected. In case the front part knocks against the running board the rod must be shortened; if the rear part strikes against the running board, the rod must be lengthened.

For changing the rod length press the ball socket from the bearing counterpart at the change lever against the engine casing. Then loosen the check nut, turn the ball socket accordingly, and press the socket again onto the bearing part located at the change lever.

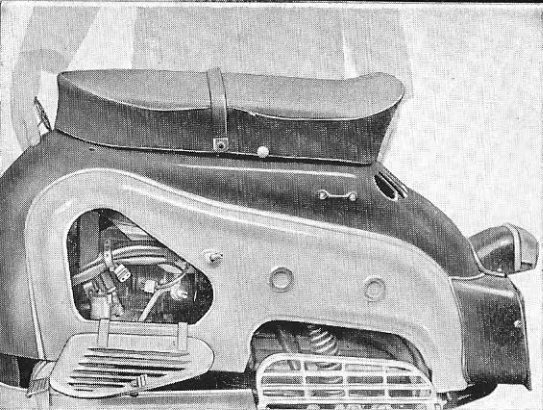

Fig. 39

### Removing Rear Casing

For better accessibility to important engine and chassis parts remove rear casing. For this purpose, loosen the 4 clamping screws on top.

If you now push the connection to the fuel tap through (outwards), open the tank cap, and detach the plug connection to the taillight on the upper frame tube within the opening of the left flap, you can lift off the body from above. For this purpose, the side flaps have to be opened.

**Important:**

Only ZUNDAPP original spare parts ensure reliability, protect against damage and keep up your guarantee. Therefore always instruct your ZUNDAPP dealer to fit only ZUNDAPP original spare parts, if you want to make sure that your machine will run without trouble and have a long life. And remember: if other than ZUNDAPP original spare parts are fitted, your guarantee becomes invalid.



W 2388 V\* engl.

**ZÜNDAPP-WERKE GMBH MÜNCHEN**