

EVOLVE

URBAN CLASSIC

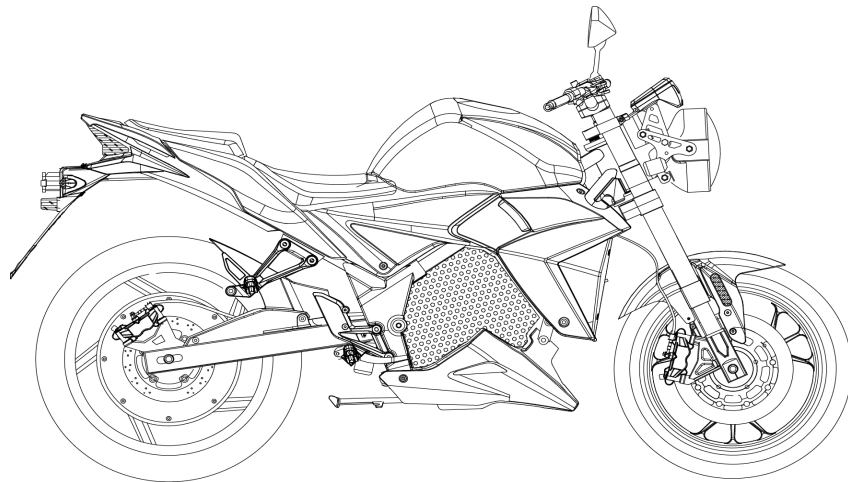

USER MANUAL

TABLE OF CONTENTS

Important Message from Evoke	7	User-serviceable Components	15
General Information	8	Maintenance you can do yourself	15
Important labels and locations	8	Vehicle Specifications	16
General Information	9	Controls and Instruments	17
Accessories and Modifications	9	Side Profile with Labels	17
General Information	10	Controls and Instruments	18
Safety precautions	10	Foot pegs	18
General Information	11	Controls and Instruments	19
Load limits and riding guidelines	11	Handlebars	19
General Information	12	Controls and Instruments	20
Pre-ride spot check	12	Left Handlebar Switchbox	20
General Information	13	Controls and Instruments	21
Identification data	13	Light settings	21
General Information	14	Controls and Instruments	22
Maintenance schedule	14	Ignition Switch	22

TABLE OF CONTENTS

Controls and Instruments	23	Brake fluid reservoir	30
Key switch	23	Getting Started	31
Controls and Instruments	24	Monitoring brake fluid	31
Key switch	24	max	31
Controls and Instruments	25	min	31
LCD display	25	Getting Started	32
Getting Started	26	Regen	32
Engage drive system	26	Battery Information	33
Controls and Instruments	27	Charging warnings	33
Right handlebar switchbox	27	Charging Information	34
Controls and Instruments	28	First time charge and calibrating the battery gauge	34
Throttle control	28	Charging Information	35
Getting Started	29	Cold weather charging	35
powering off and parking	29	Charging Information	36
Controls and Instruments	30		

TABLE OF CONTENTS

Battery Chargers and Plugging In	36	Suspension	44
Charging Information	37	Rear adjustment	44
Charging port access and location	37	Storing your Bike	45
Charging Information	38	Pre-storage cleaning	45
Charging Indication	38	Storing your Bike	47
Charging Information	39	short-term, stored state effects on battery	47
Partial Charging	39	Storing your Bike	49
Charging Information	40	short-term, stored state effects on battery	49
Battery balancing	40	Transporting your Bike	50
Charging Information	41	Preparing for transportation	50
Battery Management System (BMS)	41	Storing your Bike	51
Suspension	42	Protecting electronic elements	51
Front adjustment	42	Range, Tires, and Motor	53
Suspension	43	Reduced range	53
Front adjustment	43	Range, Tires, and Motor	54

TABLE OF CONTENTS

Increased range	54		
Range, Tires, and Motor	55		
Properly inflated tires	55		
Range, Tires, and Motor	56		
Acceleration and protection mode	56		
Troubleshooting	57		
Abnormal behavior	57		
Troubleshooting	58		
Motor protection mode	58		
Troubleshooting	59		
No power	59		
Troubleshooting	60		
Flat tire	60		
Troubleshooting	61		
Lost keys	61		
		Diagnostics and Errors	62
		Code Errors	62
		What to Do	63
		In the event of an accident	63
		What to Do	64
		In the event of an accident	64
		What to Do	65
		roadside assistance	65
		Maintenance Records	66
		Maintenance Records	67
		Warranty	68
		Dimensions	69

**THIS MANUAL MUST REMAIN WITH
THE VEHICLE AT ALL TIMES.**

IMPORTANT MESSAGE FROM EVOKE

Congratulations on purchasing your Urban S electric motorcycle! Welcome to the Evoke Motorcycle rider community. This manual will provide you with a better understanding of your motorcycle's operation and basic maintenance requirements.

Evoke is constantly improving product design and quality. Therefore, this manual contains the most current product information available at the time of printing.

If you choose to sell your Evoke Urban S, remember to pass this manual to the new owner, as it is an important part of the vehicle.

On behalf of all the Evoke team, we wish you an amazing journey and open, clear roads!

Have questions concerning operation or maintenance of your motorcycle?

Contact us!

Email: contact@evokeev.com

WeChat: Evokemotorcycles



GENERAL INFORMATION

IMPORTANT LABELS AND LOCATIONS

Evoke Urban S motorcycle series is an electric motorcycle. As such, there are warnings you should be aware of when touching or disconnecting elements.

These labels indicate that the user should take precautions to avoid harm, and are frequently seen in the following areas:

- Main Power Connection
- Phase Wire Connection
- Battery Charger
- Battery Box

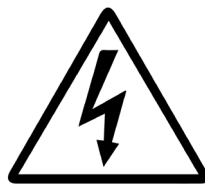

Caution indicates that minor or moderate injury could happen.



Warning indicates that serious injury or death may result.



Danger indicates that serious injury or death will occur.

GENERAL INFORMATION

ACCESSORIES AND MODIFICATIONS

We strongly advise you not to remove any original equipment or modify your Urban S in any way that would change its design or operation. Such changes could seriously impair your Urban S handling, stability, and braking, making it unsafe to ride.

Removing or modifying your lights or other equipment can also make your Urban S illegal.



Improper accessories or modifications can cause a crash in which you can be seriously hurt or killed.

Follow all instructions in this owner's manual regarding accessories and modifications.

GENERAL INFORMATION

SAFETY PRECAUTIONS

At Evoke, we want all riders to have a great time on their bikes, while also keeping in mind these precautions to avoid harm to yourself, your bike, others, and the environment:

1. Wear protective-grade clothing

- It could save your life!

2. Ride defensively

- Give yourself time and space to respond to other motorist's actions.

3. Be visible

- Other motorists may have difficulty seeing and reacting to motorcycles; always ride in the part of the lane where you are most likely to be seen.

4. Know your bike and how to use it

- Get formal training on motorcycle operation and take refresher courses.

5. Never drive while under the influence

- Drugs and alcohol impair judgement and reaction speed, putting you and other motorists in danger.

6. Always follow road rules

- This includes speed limits, using proper signaling, and avoiding weaving between lanes or other motorists.

7. Use caution in adverse weather conditions

- Your bike and other vehicles need twice the distance to stop in adverse weather conditions.

GENERAL INFORMATION

LOAD LIMITS AND RIDING GUIDELINES

Your Urban S has been designed to carry you and only one passenger. When you carry a passenger or cargo, you may feel some difference during acceleration and braking, but as long as you keep your Urban S well-maintained, with good tires and brakes, you can safely carry loads within the given limits and guidelines.

Improperly loading your Urban S can affect its stability and handling. Even if your Urban S is properly loaded, you should ride at reduced speeds when carrying cargo.



Overloading or improper loading can cause a crash and you can be seriously hurt or killed.

Follow all load limits and other loading guidelines in this manual.

GENERAL INFORMATION

PRE-RIDE SPOT CHECK

To keep yourself and others safe, perform a visual spot check on your bike before each ride:

1. Handlebars

- Make sure handlebars are secure. If they move during inspection, contact your service provider and do not ride the bike!

2. Brakes and Brake Fluid Reservoir

- Test both the front and rear brakes. If either of the brakes are unresponsive, contact your service provider immediately and avoid riding. Also check the brake fluid reservoir and refill if necessary.

3. Hoses and Lines

- If any leaks are present, contact your service provider and be extremely vigilant while riding.

4. Tires

- Make sure nothing is embedded in the tire; check the tread for wear; gauge the tire's air pressure, it should be around 40psi. If problems are present, contact your service provider.

5. Brake Lights

- Brake lights should turn on when either front or rear brake is used. If these lights are unresponsive, contact your service provider and avoid riding at night.

6. Headlight and Turn Signals

- Confirm all headlight settings and turn signals are functional. If they are not, contact your service provider and avoid riding at night.

7. Battery Power Gauge

- Confirm that the bike has sufficient battery power to get you to your destination.

GENERAL INFORMATION

IDENTIFICATION DATA

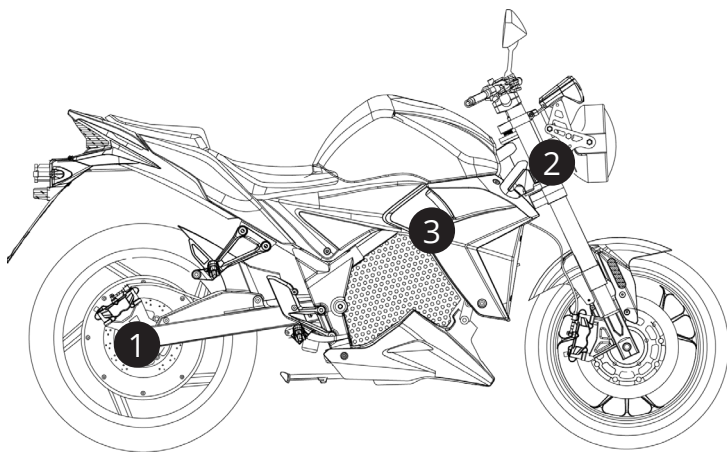

Your bike comes with three separate VIN numbers:

1. On the Motor
2. Carved into the Steering Neck
3. Mounted to the Frame

Be sure to document both and keep the numbers somewhere safe. In the unfortunate event that your bike is stolen, the authorities will need both VIN numbers to help return your bike.

GENERAL INFORMATION

MAINTENANCE SCHEDULE

The following maintenance schedule is recommended for your Urban S.

	10 000 Km	20 000 Km	40 000 Km	60 000 Km	80 000 Km	100 000 Km	120 000 Km
Battery Check Up	★	★	★		★		★
Tire Replacement		★		★	★	★	★
Brake Check Up			★		★		★
Motor Inspection			★			★	
Controller Inspection				★			★

USER-SERVICEABLE COMPONENTS

MAINTENANCE YOU CAN DO YOURSELF

1. Throttle Cable

- 1.1 Disassemble Right Side Switch Box on the handlebar
- 1.2 Remove Throttle Cable from the handle
- 1.3 Inject a 2 second burst of Lightweight lubricant down the throttle cable tube

2. Axles: Front and Rear

- 2.1 Inject a 1 second burst of Lightweight lubricant on the left and right side of the front axle
- 2.2 Inject a 1 second burst of Lightweight lubricant on the left and right side of the rear axle

3. Kickstand

- 3.1 Inject a 1 second burst of Lightweight lubricant on the upper bolt of the kickstand, securing the kickstand to the frame

4. Brake Levers

- 4.1 Inject a 1 second burst of Lightweight lubricant on the brake lever bolts, both the left and the right side
- 4.2 Squeeze the levers several time to circulate the lubricant

Required Tools: Lightweight lubricant (WD-40); Philips head screwdriver

VEHICLE SPECIFICATIONS

Top Speed	130 km/h (81 mph)
Acceleration (0-100)	6.0 seconds
Max power	19 kW
Max torque	86 lb-ft
Motor type	Hub motor
Controller	400A DC wave controller with regenerative braking
City*	200 km (125 miles)
Highway, 80 km/h (50 mph)*	125 km (75 miles)
Battery type	103.6v, 72ah Lithium Iron Evoke PowerPack
Rated nominal capacity	7.8 kWh
Chassis, Brakes & Suspension	4 hours 220v (8 hours 110v)
Front brakes	Dual disc, 4 piston hydraulic 300x4 mm
Rear brakes	Single disc, 2 piston hydraulic 220x4 mm
Front suspension	42mm inverted fork, dual shock
Rear suspension	Single shock rear

Front Wheel	3.00x17 cast aluminum
Rear Wheel	3.00x17 built-in hub motor w/ cast aluminum wheel
Front Tire	110/70-17
Rear tire	140/70-17
Pressure	280 kPa/40PSI

Storage, Weights & Dimensions

Curb weight	185 kg
Carrying capacity	150 kg
Wheelbase	1360 mm (54.4 inches)
Length	2030 mm (81.2 inches)
Width (excl. mirrors)	710 mm (28.4 inches)
Seat height	780 mm (31.2 inches)
Ground clearance	130 mm (5.2 inches)

CONTROLS AND INSTRUMENTS

SIDE PROFILE WITH LABELS

1. Handlebars
2. Headlight
3. Tank
4. Kickstand
5. Passenger seat
6. Charging port
7. Passenger foot pegs
8. Driver foot pegs
9. Motor

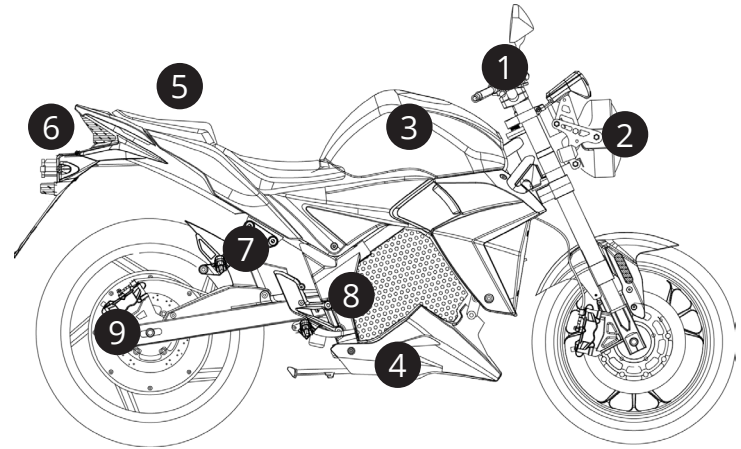

CONTROLS AND INSTRUMENTS

FOOT PEGS

All Evoke Urban S bike are equipped with two pairs of foot pegs.

The driver's foot pegs **(1)** are spring-loaded and are automatically deployed.

Passenger foot pegs **(2)** are usually folded in upright/vertical position. To deploy them, gently pull the peg into a horizontal position.

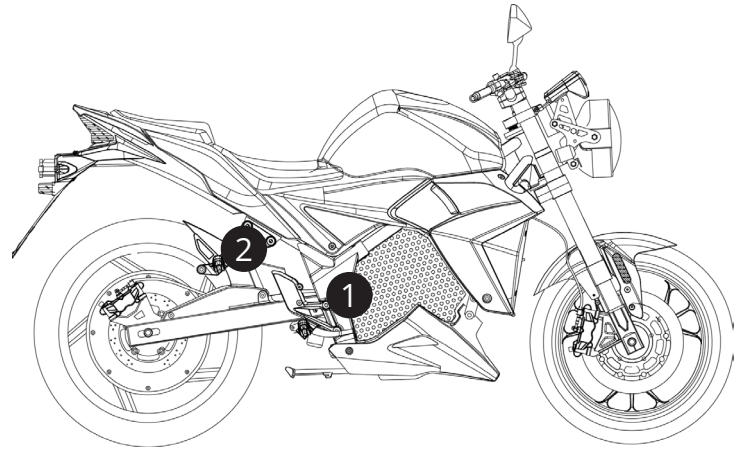

CONTROLS AND INSTRUMENTS

HANDLEBARS

1. High beam
2. Turn signal
3. Horn
4. Left rearview mirror
5. LCD display
6. Wireless starter (optional)
7. Right rearview mirror
8. Throttle Kill Switch
9. Light settings
10. Key switch



CONTROLS AND INSTRUMENTS

LEFT HANDLEBAR SWITCHBOX

1. Horn
2. Turn signal
3. High beam
4. Left rearview mirror mount

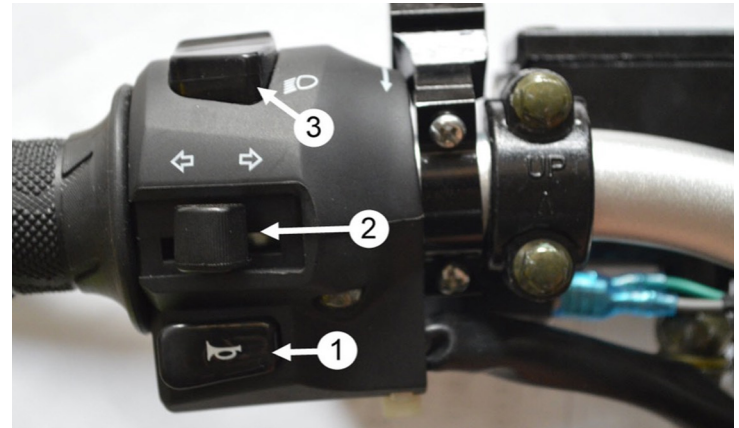

CONTROLS AND INSTRUMENTS

LIGHT SETTINGS

Light settings are used to make yourself more visible when on the road, and to alert other motorists.

1. Headlights

- To alert other motorists and illuminate the road

2. Parking Lights

- To make yourself more visible while parked

3. Off

**Vehicles equipped with DRL will automatically turn the headlight on when the vehicle is active.*

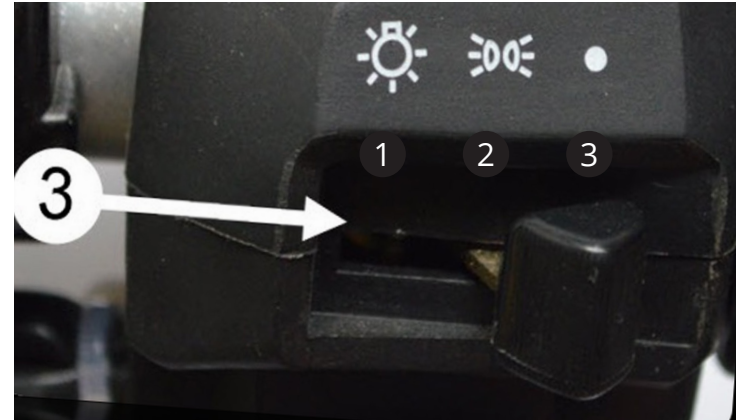

CONTROLS AND INSTRUMENTS

IGNITION SWITCH

The ignition switch is used to select the operational mode of the bike, either **ON** or **PARK** mode, and to lock the steering for theft prevention.



CONTROLS AND INSTRUMENTS

KEY SWITCH

1. Off

- No electrical circuits function.

2. On

- Insert the key and turn clockwise to the On position. The Urban S powers up. Drive mode can be engaged.

3. Lock

- Turn the handlebar all the way to the left, push down on the key, and turn counter-clockwise to the Lock (steering lock) position to lock the steering head. No electrical circuits function.



CONTROLS AND INSTRUMENTS

KEY SWITCH

DISABLING THE DRIVE SYSTEM

Set the **Start/Off** switch to the **Off** position. This will switch off the drive system.

Set the **Start/Off** switch to the **Off** position to disengage the drive system.

Turn the ignition key counterclockwise to the **Off** position. The Urban S will now power off.



CONTROLS AND INSTRUMENTS

LCD DISPLAY

1. Speed Meter
2. Motor Temperature
3. Current meter
4. Trip Distance Meter
5. Voltage Meter
6. Odometer
7. Battery Gauge
8. Error Notification
9. ODB Error
10. Turn Signals

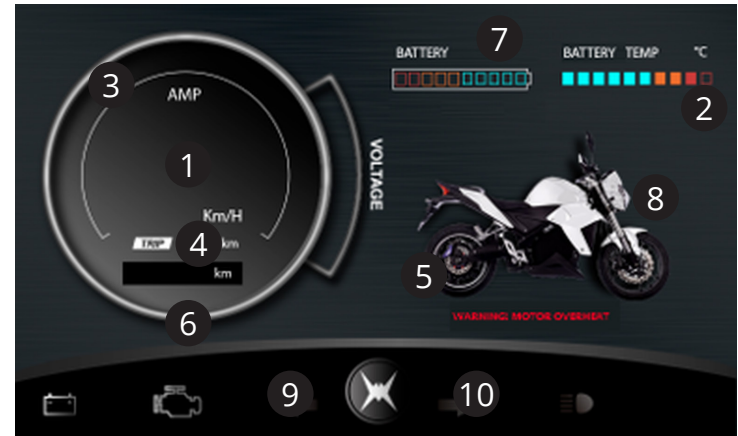

GETTING STARTED

ENGAGE DRIVE SYSTEM

To engage the drive system, insert the key that came with your bike into the key switch, located in the front-center of your handlebars. Turn clock-wise to the **ON** position.

**Ensure the Throttle Kill Switch is in the ON position and the Kickstand is in the full upright position.*

In the **ON** position, the motor is able to draw power from the battery and the bike's electronics are functional.

When in the **OFF** position, the bike's electronics will be unresponsive and the motor will not be functional.



CONTROLS AND INSTRUMENTS

RIGHT HANDLEBAR SWITCHBOX

1. Right handbrake
2. Throttle Kill Switch
3. Light settings
4. Wireless starter (Optional)
5. Throttle
6. Right rearview mirror mount

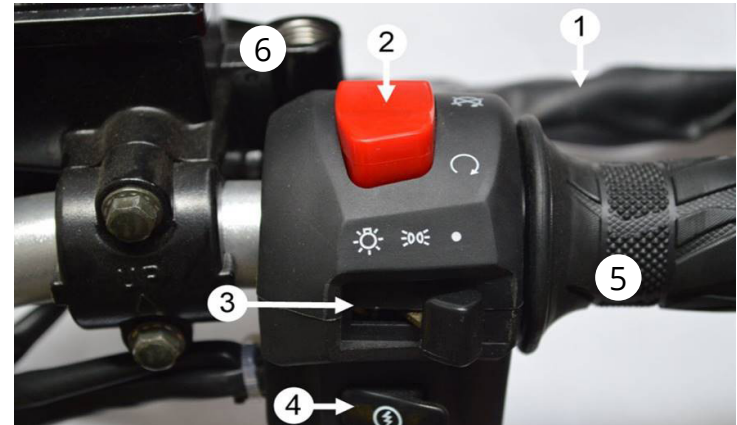

CONTROLS AND INSTRUMENTS

THROTTLE CONTROL

Twist the throttle in a counter-clockwise rotation **(A)** to energize the motor and start the motorcycle in a forward direction.

Release the throttle and it snaps back to the closed position **(B)**, de-energizing the motor, and regenerative braking begins.

When the motorcycle is moving and the throttle control is in the fully closed position, the regenerative braking feature activates.

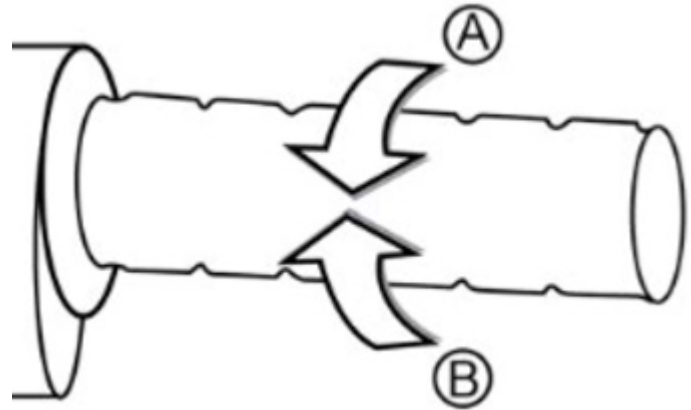

GETTING STARTED

POWERING OFF AND PARKING

Look for a level parking area. If you can't find a paved surface, make sure the ground surface is firm, especially under the kickstand. If you must park on a hill, back the rear tire downhill against the curb with the Urban S at a 45-degree angle to the curb.

KICKSTAND

Use the kickstand to support the Urban S while parked.

1. To lower the kickstand, use your foot to guide it down. Remember that lowering the kickstand will disable the drive system.
2. Check that the kickstand is down all the way.
3. If you have to park on a soft surface, insert something solid under the kickstand for support.

STEERING LOCK

The steering lock is used to lock the handlebars in place.



1. Turn the handlebars all the way to the left.
2. Insert the key into the ignition.
3. Push in on the ignition key and turn it to the Lock position (counter clockwise).
4. Remove the key from the ignition.

CONTROLS AND INSTRUMENTS

BRAKE FLUID RESERVOIR

The brake fluid reservoir is located on the backside of the right handlebar. Always be sure include checking the brake fluid levels in your pre-ride spot check as part of inspecting the brakes.

Brake fluid is a type of hydraulic fluid used to transfer force into pressure, and to amplify braking force. Due to its hygroscopic properties, the fluid absorbs moisture as it is used. When this happens, the boiling point of the fluid decreases causing your brakes to become less effective.



GETTING STARTED

MONITORING BRAKE FLUID

Ensure the clear brake fluid liquid resides at 75%, between the Min and Max marks on the clear glass fluid monitoring section.

If low, open the brake fluid reservoir with the 2 Philips head screws and fill with DOT4 brake fluid.

Make sure to close the reservoir tightly.

Wipe down any brake fluid that has spilled over, as it is detrimental to paint.

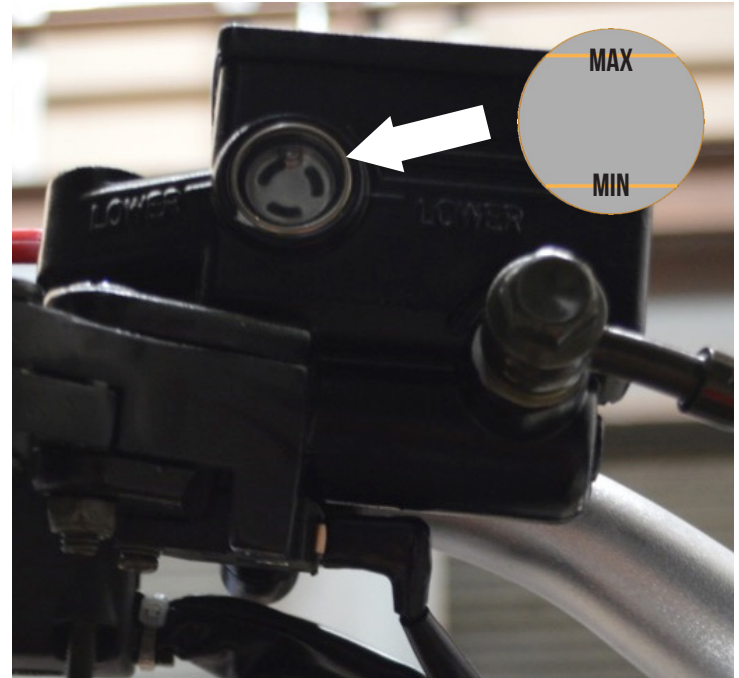

GETTING STARTED

REGEN

Slide to Regen is the default setting that comes with all Evoke bikes.

Slide to Regen activates the regenerative braking any time the throttle is not accelerating.

Slide to Regen prolongs your brake pads and provides another level of safety.

An Authorized Evoke Dealer can adjust Slide to Regen power from 10 – 50A of braking power. Default is 40A of Slide to Regen.

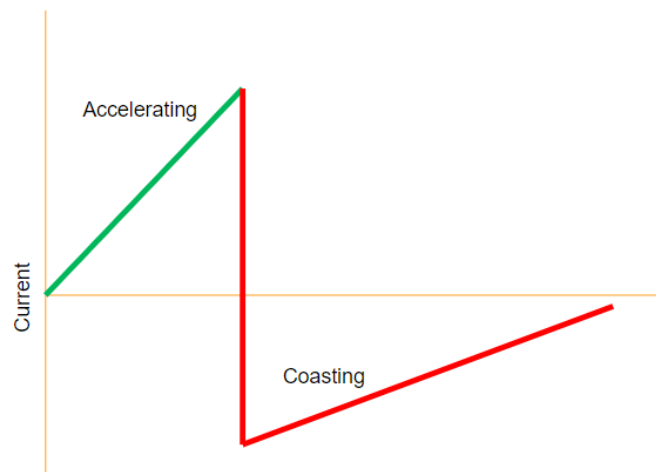

BATTERY INFORMATION

CHARGING WARNINGS

**NEVER LEAVE A CHARGING
BATTERY UNATTENDED.**

NEVER CHARGE INDOORS.



CHARGING INFORMATION

FIRST TIME CHARGE AND CALIBRATING THE BATTERY GAUGE

Before you ride your bike for the first time, you must fully charge your Evoke battery. This is because the battery gauge will need to reset, making sure that the power displayed on your LCD screen is accurate.

Each time you charge your battery, you should be charging it to full capacity and allowing the gauge to reset each time. If you fail to do so, you will not have an accurate measure of how much power you truly have in your battery.

**BEFORE YOUR
FIRST RIDE,
FULLY CHARGE
YOUR BIKE.**



CHARGING INFORMATION

COLD WEATHER CHARGING

Evoke batteries contain lithium, which becomes unstable in temperatures below 0°C (32°F).

Charging below freezing can cause permanent damage to the battery and result in reduced performance.

**AVOID CHARGING
THE BATTERY IN
ENVIRONMENTS
COLDER THAN
0°C (32°F).**



CHARGING INFORMATION

BATTERY CHARGERS AND PLUGGING IN

Evoke Battery Chargers contains 3 segments:

- Input Stage Wire (110v or 220v)
- Power Charger
- Output Stage Wire (DC Voltage)

The Input Stage Wire connects to the outlet or Charging Station directly to control charging.



CHARGING INFORMATION

CHARGING PORT ACCESS AND LOCATION

1. Charging from a Standard Outlet

- 1.1 Open charging port cap **(1)**
- 1.2 Insert charging pistol into the charging port.
- 1.3 Plug in the Standard Outlet plug into the wall socket.

2. Charging at a Charging Station (1)

- 2.1 Open charging port cap.
- 2.2 Insert charging pistol into the charging port.

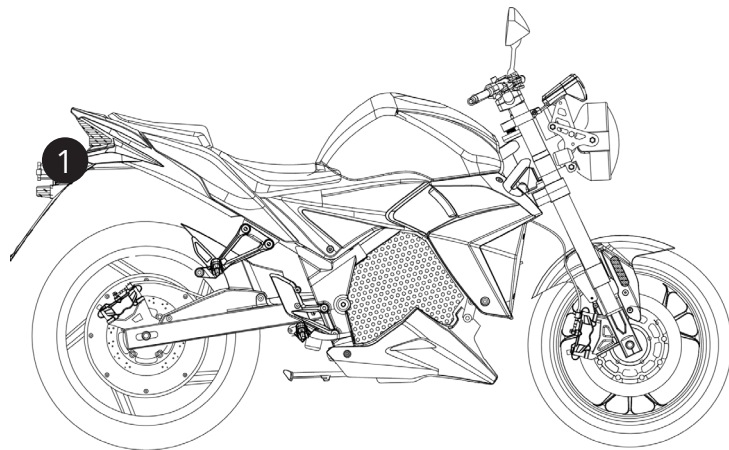

CHARGING INFORMATION

CHARGING INDICATION

1. The On-board Charger Fan will turn on.
2. On the LCD screen, the top most bar of the battery gauge will blink.
3. The vehicle throttle will not be active.



CHARGING INFORMATION

PARTIAL CHARGING

1. On-board Fast Charger (220v)

- One block represents approximately **25 minutes** of a charge
- One block represents approximately **20 km** of range

2. On-board Fast Charger (110v)

- One block represents approximately **50 minutes** of a charge
- One block represents approximately **20 km** of range

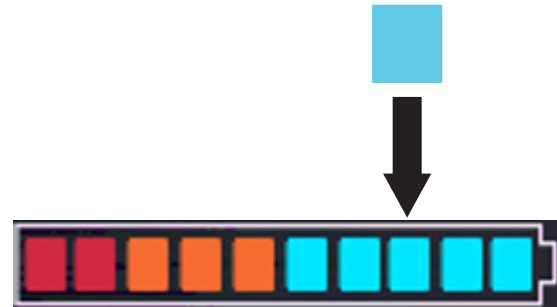

CHARGING INFORMATION

BATTERY BALANCING

Keeping all of the battery cells balanced is vital for optimal battery performance. Evoke recommends that you leave your Urban S on in charge mode with AC power connected to allow the cells to balance.

1. Every 3 months, discharge your bike to near empty. (20% State of Charge)
2. Charge your battery for 10 hours on the slow charger, or 5 hours on the on-board fast charger.
3. Run your bike to 80% SOC (State of Charge)
4. Your bike's battery pack is fully balanced and calibrated.

CHARGING INFORMATION

BATTERY MANAGEMENT SYSTEM (BMS)

In most cases, the BMS is fully automatic, protecting the vehicle and the battery pack from:

- Extreme temperatures,
- Short circuits,
- Overcharging and over-discharging,
- Unbalancing

In the event the BMS goes into protection and the unit does not automatically recover, there is a manual override switch located underneath the rear seat.

1. Turn on bike
2. Remove rear seat
3. Push and hold the button for a minimum of 5 seconds
4. The battery will make a long beep sound to confirm it is active

5. The button will also glow blue to indicate the BMS is active



SUSPENSION

FRONT ADJUSTMENT

Spring preload adjustment screws (both forks)

Adjusting the preload lets you change the “unloaded” sag of the suspension system.

- Turning the nut clockwise increases the spring preload and reduces the “unloaded” sag of the suspension system.
- Turning the nut counter-clockwise decreases the spring preload and increases the “unloaded” sag of the suspension system

To adjust the spring preload, always start from the minimum preload position (nut turned fully counter-clockwise). Take note of number of turns and adjust both forks equally.

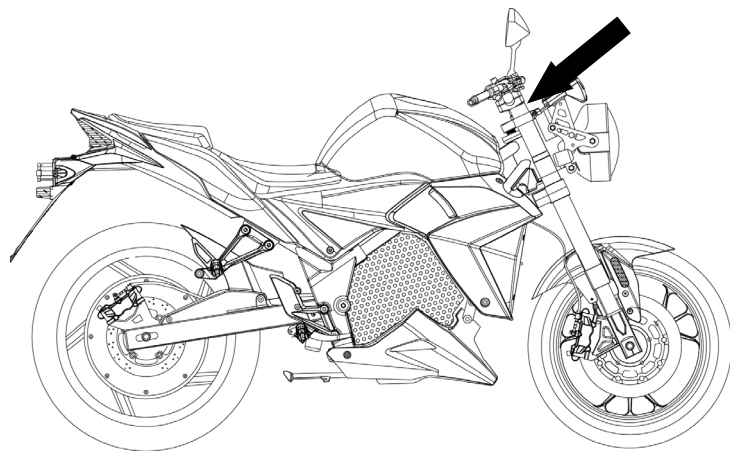

SUSPENSION

FRONT ADJUSTMENT

Rebound damping (right fork)

Rotate the adjuster screw clockwise to stiffen the damping (+) and counter-clockwise to soften it (-).



Compression damping (left fork)

Rotate the adjuster screw clockwise to stiffen the damping (+) and counter-clockwise to soften it (-).



SUSPENSION

REAR ADJUSTMENT

Adjust the spring pre-load by rotating the two pre-load rings:

- Counter-clockwise to decrease the pre-load
- Clockwise to increase the pre-load

To adjust the pre-load back to the original setting used during manufacture, raise the rear wheel off the ground using a safety stand or a hoist. Rotate the pre-load ring counter-clockwise until it is loose. Then, rotate the pre-load ring clockwise four turns.

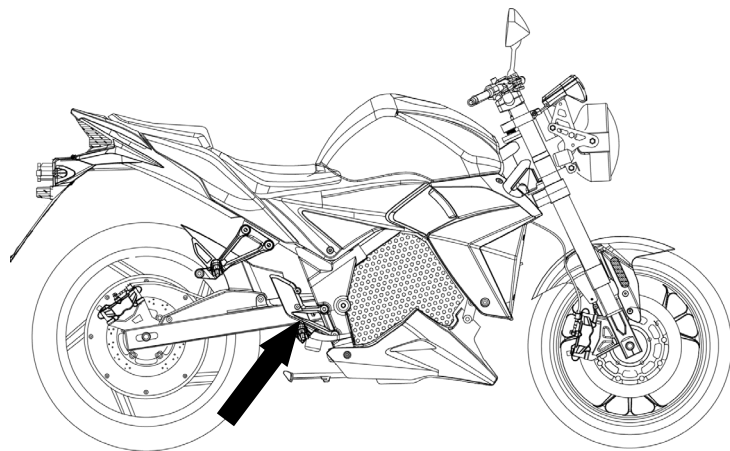

STORING YOUR BIKE

PRE-STORAGE CLEANING

Before storing your bike, clean and polish it. This will help keep the bike looking newer for longer, it also makes it easier to inspect and service. Do not expose your bike to harsh detergents or chemical solvents, as this could damage its metal, paint, or plastic.

To clean your bike, use a sponge or soft towel, mild detergent, and water.

Washing your Urban S in bright sunlight may cause the finish to fade, because water droplets intensify the sun's brightness. Spotting is also more likely because surface water can dry before you have time to wipe it off.

To avoid this, clean your bike in a shaded area, out of direct sunlight.

DO NOT USE A PRESSURE WASHER TO CLEAN YOUR BIKE. HIGH-PRESSURE WATER OR AIR MAY DAMAGE IT. NEVER AIM JETS OF WATER AT THE BATTERIES OR OTHER ELECTRICAL COMPONENTS. DAMAGE CAUSED FROM USING A PRESSURE WASHER WILL NOT BE COVERED BY THE EVOKE LIMITED WARRANTY.



**YOUR BIKE IS CONSIDERED TO BE
IN A “STORED” STATE IF IT GOES
UNUSED FOR MORE THAN THREE
DAYS.**



STORING YOUR BIKE

SHORT-TERM, STORED STATE EFFECTS ON BATTERY

While in a short-term stored state, the bike's battery should be around 50% SoC (State of Charge), and never completely full or empty. Storing the battery at full charge can result in decreased battery life, whereas storing at empty can result in complete battery dysfunction. To ensure a long battery life, only store your bike between 50% SoC.

**BATTERIES SHOULD
ONLY BE STORED
AT AROUND 50%
SOC.**



“LONG-TERM” STORAGE IS DEFINED AS STORAGE LASTING LONGER THAN TWO WEEKS.



STORING YOUR BIKE

SHORT-TERM, STORED STATE EFFECTS ON BATTERY

If you will not be riding your bike for any amount of time lasting longer than two weeks, thoroughly inspect and correct any problems before storage so that issues are not forgotten about in the meantime. Then, disconnect the Battery Safety Disconnect to reduce quiescent drain on the batteries.

During storage, periodically (every 1 - 2 months) check the SoC and charge if necessary.

After reconnecting the Battery Safety Disconnect, the Urban S must be powered on to allow for a full electrical system test and then, if necessary, charged.

**BATTERIES SHOULD BE STORED
BETWEEN 50-60% SOC, IN
TEMPERATURES BETWEEN
0-24°C (32-75°F).**



TRANSPORTING YOUR BIKE

PREPARING FOR TRANSPORTATION

If your Urban S needs to be transported, it should be carried on a motorcycle trailer, a truck, or a flatbed trailer. **Do not tow your Urban S.**

When contacting a towing or transporting service, be sure to ask if they have a flatbed area, loading ramp, or power ramp to safely lift the Urban S. Also ask if they have motorcycle tie-down straps.

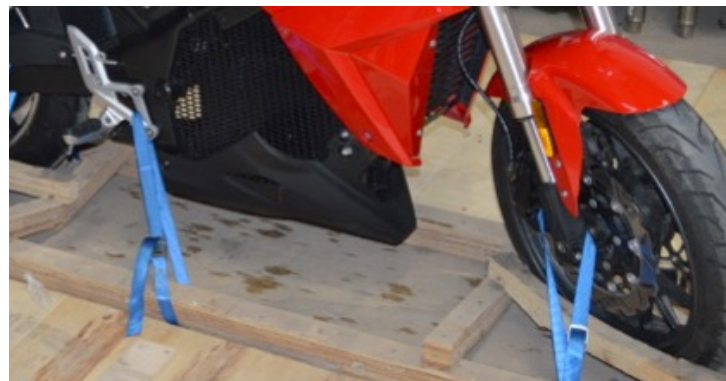
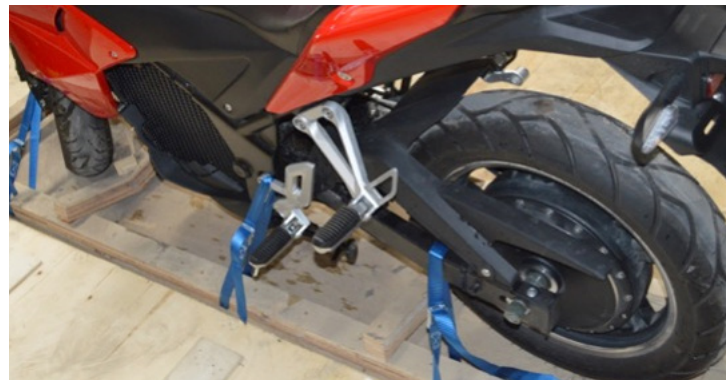

STORING YOUR BIKE

PROTECTING ELECTRONIC ELEMENTS

As a general rule, when storing any vehicle for long periods it's best to use a protective cover to prevent the elements from affecting the vehicle's internal components.

Be sure that the storage area is dry and not in located in direct sunlight, as this can also affect the bike's performance following the conclusion of storage.

Avoid using plastic or similar non-breathing materials during storage, as these restrict air-flow and allow heat and moisture to accumulate on the bike.

ALWAYS USE A PROTECTIVE TARP AND STORE IN A COOL, DRY AREA.



**MANY FACTORS AFFECT
THE RANGE OF YOUR BIKE.**



RANGE, TIRES, AND MOTOR

REDUCED RANGE

The following factors are considered range reducers. This means that your bike will be using more power to move and, as a result, will not be able to move as far.

Temperatures below 25°C (77°F), sitting upright while riding, carrying excess weight or passengers, accelerating hard, improperly inflated tires, and mountainous terrain will all keep you from traveling long distances.

Remember to take this into consideration when planning road trips!

- Cool temperatures
- Sitting upright
- Excess weight
- Mountainous terrain
- Accelerating hard
- Soft tires

RANGE, TIRES, AND MOTOR

INCREASED RANGE

The following factors are considered range increasers. This means that your bike will be using less power to move and, as a result, will be able to move further.

Temperatures above 25°C (77°F), leaning forward while riding, soft accelerating, properly inflated tires, and flat terrain will all help you to travel longer distances.

Remember to take this into consideration when planning long journeys!

- Warm temperatures
- Leaning forward
- Flat terrain
- Soft acceleration
- Properly inflated tires

RANGE, TIRES, AND MOTOR

PROPERLY INFLATED TIRES

To safely operate your Urban S, your tires must be the proper type and size, in good condition with adequate tread, and correctly inflated for the load you are carrying.

Inspection

Whenever you check the tire pressures, you should also inspect the wheel and tire to see if any of the following are evident:

Dents, cracks or any other damage to the wheel. Replace the wheel if damaged.

Bumps or bulges in the side of the tire or the tread. Replace any tire that has a bump or bulge.

Cuts, slits, or cracks in the tire. Replace the tire if you can see fabric or cord.

Using tires that are excessively worn or improperly inflated can cause an accident in which you can be seriously hurt or killed.

**BOTH THE FRONT AND
REAR TIRES SHOULD
MEASURE 37 - 40
PSI.**



RANGE, TIRES, AND MOTOR ACCELERATION AND PROTECTION MODE

The amp readout on your LCD tells you how many relative amps you are pulling out of the battery. If you are consistently “accelerating hard,” meaning that your current gauge is constantly in the RED, you risk entering **Motor Protection Mode**.

Motor Temperature can be monitored with the following gauge indicated on the right had side of this page.

In protection mode, only 15% of total power will be available for use, giving you just enough to power to pull over in a safe location. When this happens, simply shut the bike down for a few minutes and allow the Motor to cool down. Knowing how to monitor your acceleration and adjust your riding can help you maintain range and avoid protection mode.



Know how to monitor your acceleration and adjust your riding to maintain range.

TROUBLESHOOTING

ABNORMAL BEHAVIOR

If your bike is behaving in an abnormal manner, the first thing you should try is to simply shut it off and then restart it again. In most cases, this will resolve whatever the issue was. However, if it does not resolve your problems, contact your service provider for more assistance.

**SHUT THE BIKE DOWN
FOR AT LEAST TWO
MINUTES AND THEN
RESTART THE BIKE.**



TROUBLESHOOTING

MOTOR PROTECTION MODE

The motor has become too hot as a result of hard acceleration, and only 15% of total power is available for use, giving you just enough to power to pull over in a safe location. When this happens, simply shut the bike down for a few minutes and allow it to cool down. If the bike does not resume normal operation after allowing it to cool down, contact your service provider.

GET TO A SAFE LOCATION AND SHUT THE BIKE DOWN FOR AT LEAST TWO MINUTES. ONCE THE MOTOR COOLS DOWN, THE BIKE WILL BE OPERATIONAL AGAIN.



TROUBLESHOOTING

NO POWER

Your bike has no power.

1. The bike may be out of charge.
2. Get the bike to the nearest outlet and plug it into the charger, and charge the bike
3. If On-board Charger does not turn on, then:
 - Open the rear seat
 - Check if the BMS Switch is ON
 - If the BMS Switch is OFF, press and hold the BMS Switch for 5 seconds to active BMS.
4. If this does not resolve the issue, contact your service provider.

PLUG YOUR BATTERY INTO THE NEAREST OUTLET AND LET IT CHARGE.



TROUBLESHOOTING

FLAT TIRE

Riding on a flat tire is unsafe and may cause bodily harm and/or death.

As soon as you notice a flat tire, pull over to the side of the road in a safe location and shut the bike down. Do not ride the bike.

Do not push the bike. Do not move the bike.

Transport the bike via tow truck or flatbed to the nearest Authorized Evoke Dealer for a tire replacement.

**GET TO A SAFE LOCATION
AND SHUT THE BIKE DOWN.
DO NOT RIDE ON A FLAT TIRE.
TRANSPORT YOUR BIKE TO
THE NEAREST AUTHORIZED
EVOKE DEALER.**



TROUBLESHOOTING

LOST KEYS

Your Urban S was supplied with two keys. Evoke recommends that you keep one key in a safe location, as a spare, in case you misplace the other.

If one or both keys are lost, contact your Evoke Authorized Dealer for replacement options.



DIAGNOSTICS AND ERRORS

CODE ERRORS

Code	Description
0x001	Charger overvoltage protection
0x002	Charger overcurrent protection
0x003	Charger is in over current protection
0x004	BMS overheat
0x005	Charging current error
0x006	Pack out of balance
0x007	BMS overheat
0x008	Controller error
0x009	Discharging level
0x010	Discharge overcurrent protection
0x011	Battery depleted
0x012	Battery overheat
0x013	Discharge BMS overheat
0x014	Discharge BMS overheat
0x015	BMS short circuit protection
0x016	BMS error
0x017	Single cell undervoltage

Code	Description
0x018	Charger hardware failure
0x019	Charger temperature is too high
0x020	Charger input voltage wrong. Charger inactive
0x021	Hall sensor failure
0x022	Motor stalled
0x023	Controller overcurrent
0x024	Controller overvoltage
0x025	Power saving mode
0x026	Limp home mode
0x027	Protection shutdown mode
0x028	Throttle open from start
0x029	Throttle failure
0x030	Controller thermal warning
0x031	Controller thermal shutdown
0x032	Motor overheat
0x033	Motor overheat shutdown
0x034	Main contactor failure

WHAT TO DO

IN THE EVENT OF AN ACCIDENT

DISCONNECT main battery connector located to the rear of the front fork, beneath the body panels

First Responder Information - High Voltage Components Locations

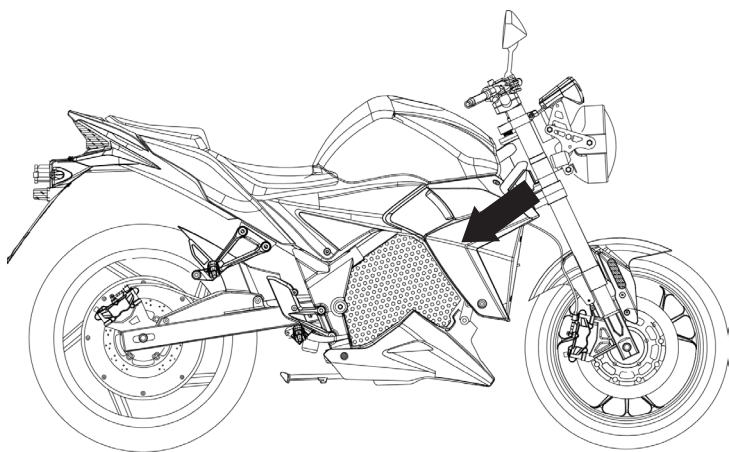

HIGH voltage components may remain energize for up to 60 second after disabling.

NEVER CUT HIGH VOLTAGE COMPONENTS OR CABLING.

CUTTING THE CABLING COULD RESULT IN SERIOUS INJURY OR DEATH.



WHAT TO DO

IN THE EVENT OF AN ACCIDENT

DISCONNECT main battery connector located behind front fork

First Responder Information - High Voltage Components Locations

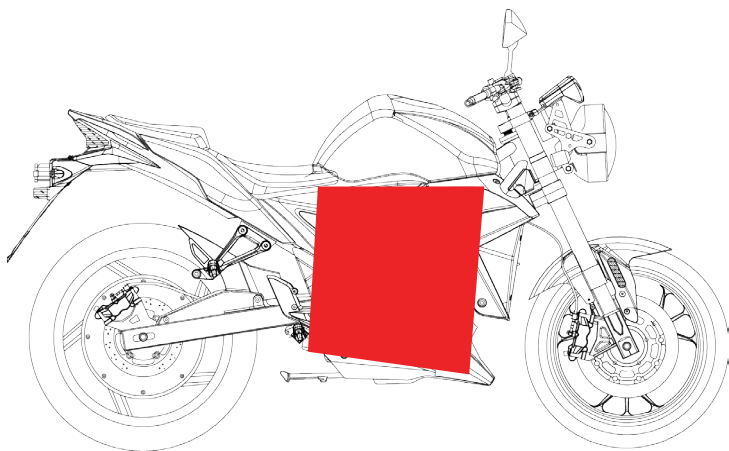

DO NOT PUNCTURE RED AREAS ON THE IMAGE.



WHAT TO DO

ROADSIDE ASSISTANCE

Emergency roadside assistance is standard on all new Evoke Urban S models for the duration of the warranty period. Contact your authorized Evoke Urban S dealer for further information.

Product quality and customer satisfaction are critical ingredients to the success of Evoke.

This information is designed as a tool to help you understand how to efficiently service our products by working with an Authorized Evoke Dealer near you or a Regional Dealer Support Representative.

Should a question or problem arise concerning service and warranty which cannot be resolved by an Authorized Evoke Dealer or a Regional Dealer Support Representative, please contact Evoke headquarters directly.

contact@evokeev.com

MAINTENANCE RECORDS

After you have had your Urban S serviced, please make sure that the appropriate maintenance record has been completed.

10.000 km		20.000 km	
Date:		Date:	
Notes:		Notes:	
Performed by:		Performed by:	
40.000 km		60.000 km	
Date:		Date:	
Notes:		Note:	
Performed by:		Performed by:	

MAINTENANCE RECORDS

80.000 km		100.000 km	
Date:		Date:	
Notes:		Notes:	
Performed by:		Performed by:	
120.000 km		130.000 km	
Date:		Date:	
Notes:		Note:	
Performed by:		Performed by:	

WARRANTY

Items Not Covered By Warranty

The warranty shall NOT apply to:

- Normal maintenance and service, including, without limitation, adjustments to brakes, tire pressure, due to wear and tear from operation of the vehicle and not as a result of a defect in materials and workmanship;

The replacement of normal wear parts, including, without limitation, all rubber parts, bulbs, lenses, wires, cables, fuses, tires, tubes and brake lines, due to wear and tear from operation of the vehicle and not as a result of a defect in materials and workmanship;

Any repairs or replacements required as a result of accidents or collision;

Any defects caused or repairs required as a result of abusive operation, negligence, accident, improper installation (modification), or inappropriate use as outlined in this Owner's Manual;

Any products tampered with, modified, adjusted, or repaired by any unauthorized party, including the owner;

Any damage caused or resulting from the use of inappropriate tools;

Any additional accessory installed by the owner which causes defect of additional parts;

Any damage caused by external or environmental conditions such as abnormal weather, accidents, earthquake, etc;

Any product received without appropriate model and frame serial number identification;

Any product used for rental or racing purposes;

Any cosmetic damage to the surface or exterior;

Failure to use vehicle in the proper manner, or follow the maintenance and storage procedures in this Owner's Manual (i.e., motorcycle designed for "on the road use" and used as "off road vehicle").

All Evoke electric motorcycles come with a 2 year or 20,000km tire to tire warranty.

All Evoke lithium ion batteries are warranted for 2 years or 20,000km (Unless otherwise stated)

DIMENSIONS

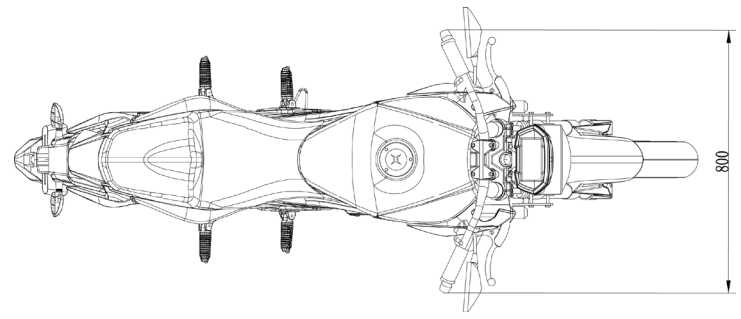
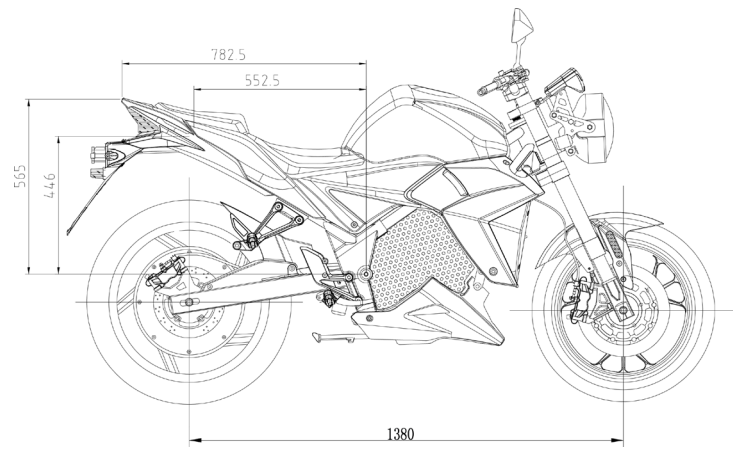

WEBSITE: WWW.EVOKEMOTORCYCLES.COM

WWW.EVOKEEV.COM

CONTACT@EVOKEEV.COM